



PLZ-5W / 5WZ SERIES



DC ELECTRONIC LOAD

Multifunctional Electronic Load PLZ-5W/5WZ Series

Operation Voltage : 1 V to 150 V (from 0.05 V)

High Speed Slew Rate : 60 A/ μ s

Arbitrary I-V Characteristics: "ARB Mode" included

Parallel Operation Feature: Total current and power can be increased to a maximum of 10.8 kW (2160 A) with booster units.

High resolution color LCD display

Various Communication Interfaces : LAN (LXI compliant), USB, RS232C, GPIB (Option), External Analog Control

Improved Sequence Feature (Maximum 10000 steps)

Impedance Measurement Function



The New Flagship model is born!

Introducing the new standard of Electronic Load !

High-speed response, universal interface, large-scale system compatibility

The PLZ-5W series electronic load is the successor of the highly respected PLZ-4W that continues the series tradition of high specification and excellent build quality.

New improvements include a user-friendly LCD color display and a wide voltage range from 1 V to 150 V.

Custom voltage/current profiles can now be programmed using the new ARB function, ideal for LED driver and solar panel testing. The PLZ-5W now includes 6 basic modes of operation (CC, CR, CV, CP, CC+CV, & CR+CV) for optimal flexibility in any test facility.

The PLZ-5W is now equipped with a high-speed response feature boasting a maximum slew rate of 60 A/us (PLZ1205W) and a minimum setting resolution of 10 uA (PLZ205W).

Additional features include a soft-start function, variable slew rate, selectable response mode (CV/CR mode), switching function, ABC programmable memory, 20 user-defined setup configurations, and a sequence function. The high-speed response of the PLZ-5W is ideal for the development and testing of modern day power supplies that require sudden changes in current at high speeds as well as for testing of current clamps and transducers. The PLZ-5W series is available in 4 standard models which can be incrementally expanded by adding booster units (PLZ2405W) for a maximum of 10.8 kW/2160 A. The PLZ-5W now is equipped with a diverse digital communication interface supporting LAN (LXI), USB, RS232C, analog control, and GPIB as a factory option.



Detachable input terminals for ease of use.



Actual size

Applications

Research and development of photovoltaic, (hybrid) electric vehicle drives, fuel cell technologies, batteries, LEDs and power supplies.



PLZ1205W
PLZ2405WB

PLZ205W
PLZ1205W

D C E L E C T R O N I C L O A D

Multifunctional Electronic Load PLZ-5W Series

| Model | Operating voltage | Current | Power |
|-----------|-------------------|---------|--------|
| PLZ205W | 1 V to 150 V | 40 A | 200 W |
| PLZ405W | | 80 A | 400 W |
| PLZ1205W | | 240 A | 1200 W |
| PLZ2405WB | | 480 A | 2400 W |

[functions]

- Parallel operation ●Communication function ●Current monitor output ●Variable slew rate ●Switching function ●Soft start function ●Elapsed time display and auto load off timer ●Remote sensing function ●Load on/off operations ●Range control input ●Trigger input ●Alarm input ●Alarm status output ●Load-on status signal output ●Range status output ●Short-circuit function ●External voltage control input(CC, CR, CV and CP modes) ●Overvoltage protection (OVP) ●Overcurrent protection (OCP) ●Overpower protection (OPP) ●Overheat protection (OTP) ●Undervoltage protection (UVP) ●Reverse connection detection (REV)

Color liquid crystal display (LCD)

Highly resolution color display allows for the convenient monitoring of values such as voltage, current, power, current capacity (Ah) and power capacity (Wh) all in the same place.

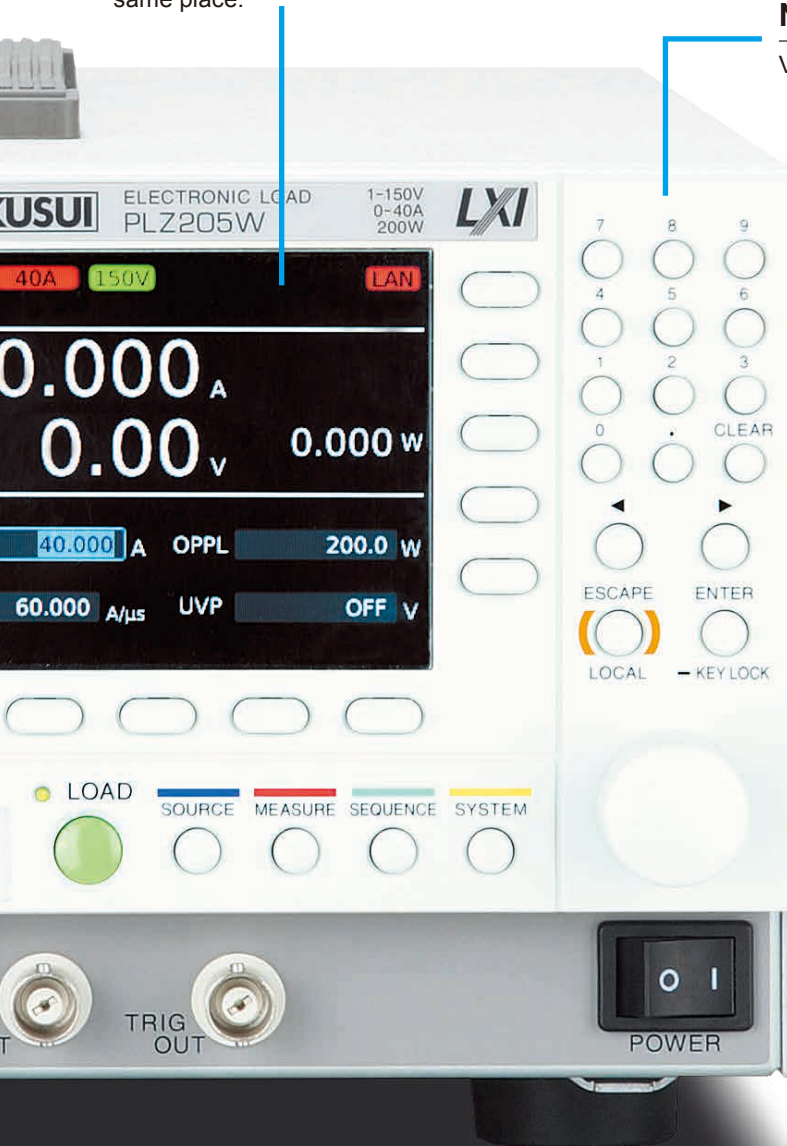

New numeric keypad for easy operation

Values can now be input directly from the front panel.

Maximum slew rate of 60 A/ μ s

The PLZ-5W series boasts a 4 μ s rise time, easily satisfying the critical needs of power supply evaluation tests demanding a fast transient response.

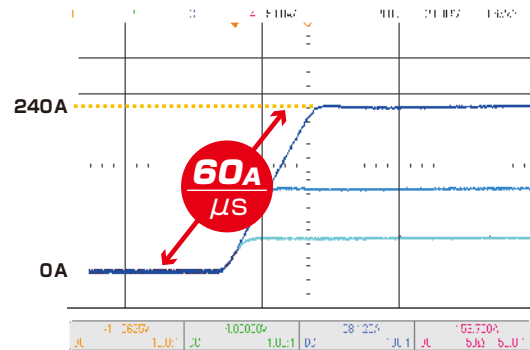

High speed voltage tracking characteristics

High speed voltage tracking in CR mode is perfect for applications such as power supply startup tests.

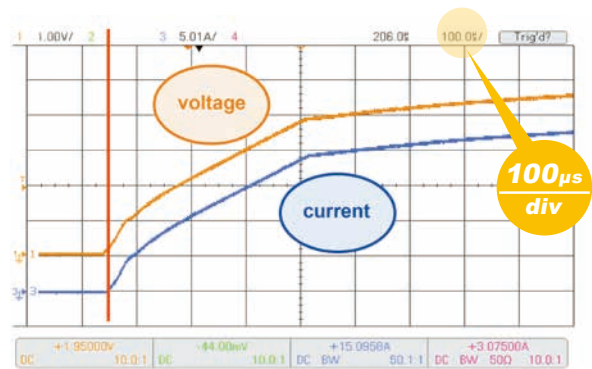

Wide-ranging digital interface

LAN (LXI) / USB / RS232C as standard interface *GPIB Option

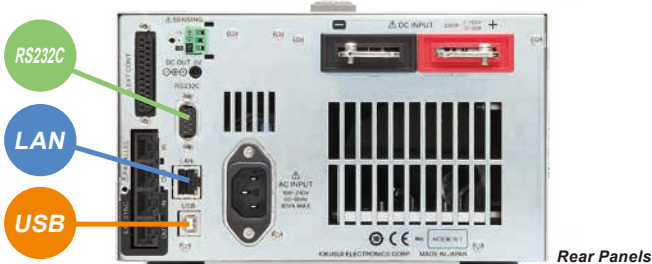

Use a browser from a PC, smartphone, or tablet to access the web server built into the PLZ-5W series for convenient control and monitoring.

[Recommended browser]

- Internet Explorer version 9.0 or later
- Firefox 8.0 or later
- Safari/Mobile Safari 5.1 or later
- Chrome 15.0 or later
- Opera 11.0 or later

*Connecting with a smartphone, tablet, etc. requires a Wi-Fi environment (wireless LAN router etc.).

LXI compliant!!
control and monitor the power from built-in browser!

Application software

Sequence Creation Software SD023-PLZ-5W

SD023-PLZ-5W (Wavy for PLZ-5W) is the proprietary Kikusui software for sequence creation and control of Kikusui power supplies and electronic loads. "Wavy" software allows for easy sequence creation and editing without prior programming knowledge. Wavy software can be used for remote control of the electronic load, monitoring of voltage and current values, and for data logging.

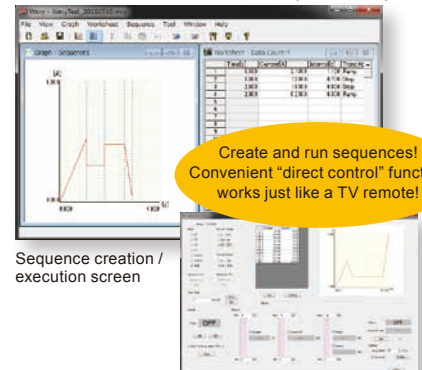

[See P15]

*For details, please see our company's homepage.

Operation modes

The following five operation modes are available on the PLZ-5W. These can be selected when the load is in the off state.

| | |
|--|--|
| Constant current (CC) mode | A current value is specified and the current is kept constant even when the voltage changes. |
| Constant resistance (CR) mode | A conductance value is specified and the PLZ-5W sinks current proportional to the voltage variation. |
| Constant voltage (CV) mode | A voltage is specified and the PLZ-5W sinks current so that the voltage at the load input end of the PLZ-5W is constant. |
| Constant power (CP) mode | A voltage is specified and the PLZ-5W sinks current so that the power consumed inside the electronic load is constant. |
| Arbitrary I-V characteristics (ARB) mode | The desired load characteristics can be set by specifying multiple arbitrary voltage values and current values as I-V characteristics. |

Adjustable slew rate

The speed of change can be set when the current is changed. The slew rate setting will function in the following instances.

- When the setting is changed to vary the current value (including the switching function).
- When the current value is changed using external control in constant current (CC) mode.
- When the current value is changed while the load is on.

CC Mode / High range / 0-80A Switching

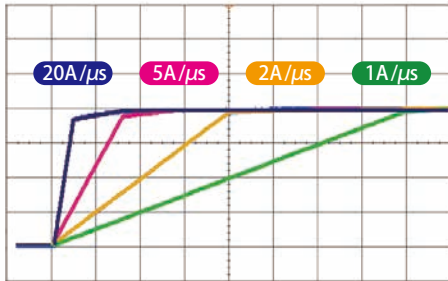

Ch4 load current 20A/div Horizontal 10μs/div

▲ Shift in the current waveform with the change in the slew rate

The slew rate is set according to the current range as an amount of current change per unit of time. Moreover, a common value is set for the rise and fall speeds. In CC mode and ARB mode, the slew rate can be set regardless of whether the load is on or off.

High precision and high resolution

The built-in three-range configuration provides wide dynamic range and high precision.

● PLZ205W operating range and setting resolution

| | | Operating range | Setting resolution |
|---------------------------|---------|-------------------|--------------------|
| Constant current mode | H range | 0 A to 40 A | 1 mA |
| | M range | 0 A to 4 A | 0.1 mA |
| | L range | 0 A to 0.4 A | 0.01 mA |
| Constant resistance mode* | H range | 40 S to 0.002 S | 1 mS |
| | M range | 4 S to 0.0002 S | 0.1 mS |
| | L range | 400 mS to 0.02 mS | 0.01 mS |
| Constant voltage mode | H range | 1 V to 150 V | 5 mV |
| | L range | 1 V to 15 V | 0.5 mV |
| Constant power mode | H range | 20 W to 200 W | 0.005 W |
| | M range | 2 W to 20 W | 0.0005 W |
| | L range | 0.2 W to 2 W | 0.00005 W |

* Conductance [S] = Input current [A] / Input voltage [V] = 1 / Resistance [Ω]

Load on/off operation

The following load on/off settings are available in addition to standard operations that can be carefully adjusted to fit the needs of any test environment.

- Start with "load on" when power is turned on
- Display elapsed "load on" time
- Auto "load off" when time limit is reached
- Control "load on/off" with external controls such as relays

Arbitrary I-V characteristics (ARB) mode

In ARB mode arbitrary I-V characteristics can be set by entering multiple I-V points (voltage and current value set points). 3 to 100 points can be registered and the spaces between all points are automatically linearly interpolated. This mode can be used for the simulation of LED drivers and other DUT's with non-linear characteristics.[P8]

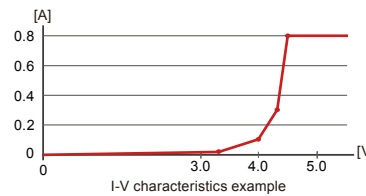

Example of settings

| Voltage [V] | Current [A] |
|-------------|-------------|
| 0 | 0 |
| 3.2 | 0.02 |
| 4.0 | 0.1 |
| 4.3 | 0.3 |
| 4.5 | 0.8 |
| 157.5 | 0.8 |

Short function

When the short function is activated, the maximum current value will be set if in CC mode, and the minimum voltage value will be set if in CR mode. The relay contact (30 Vdc/1 A) of the EXT CONT connector closes, and the load input terminals can then be shorted by driving an external high-current relay.

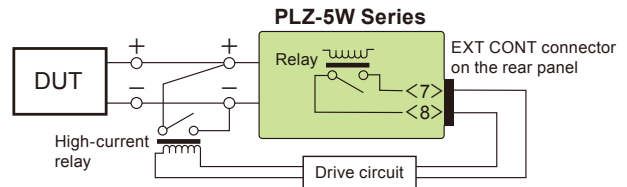

Switching function

Switching mode can be performed at up to kHz while in CC and CR modes. The switching setting parameters such as switching level, frequency, and duty factor can be changed at any time, even while the load is on.

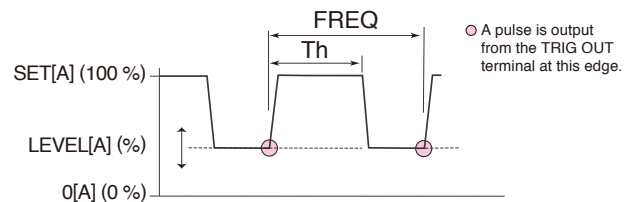

[Setting parameters]

■ Operation mode: CC and CR

■ Frequency setting range: 1 Hz to 100 kHz

■ Frequency setting resolution

| | |
|-------------------|-------------------------|
| 1 Hz to 10 Hz | 0.1 Hz |
| 11 Hz to 100 Hz | 1 Hz |
| 110 Hz to 1 kHz | 10 Hz |
| 1.1 kHz to 10 kHz | 0.1 kHz |
| 10 kHz to 100 kHz | 20 kHz, 50 kHz, 100 kHz |

■ Frequency setting accuracy: ±(0.5 % of set)

■ Duty factor, steps

| | |
|---------------------|---------------------------------|
| 1 Hz to 10 Hz | |
| 11 Hz to 100 Hz | 5.0% to 95.0%, in steps of 0.1% |
| 110 Hz to 1000 Hz | |
| 1.1 kHz to 10.0 kHz | 5.0% to 95.0%, in steps of 1% |
| 10 kHz to 100 kHz | 10% to 90%, in steps of 10% |

* The minimum time interval for setting the duty factor is 5 μs.

Soft start function

The soft start feature controls the rise time of the load current. The soft start feature can be activated when the following conditions are met.

- The rise time of the soft start has been set.
- "Load on" while in CC Mode.
- Soft start input settings start from zero input and end equal to or above the minimum operating voltage (0.05 V).

This function can be used if the output of the DUT becomes unstable when the load current rises sharply, or when the operator wishes to delay the current change on startup to prevent the DUT's overcurrent protection circuit from being activated.

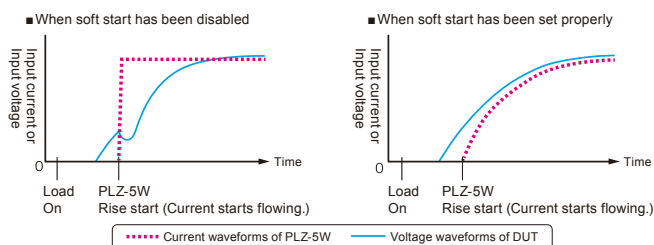

Can be set to OFF / 100 μs / 200 μs / 500 μs / 1 ms / 2 ms / 5 ms / 10 ms / 20 ms. This sets the soft start time.

Sequence function

The operator can execute a long sequence of predetermined values with the sequence function. A sequence consists of programs and steps. A program is a collection of steps, which are executed in order, one by one, starting from step 1. The program is considered complete after the last step in the program is executed.

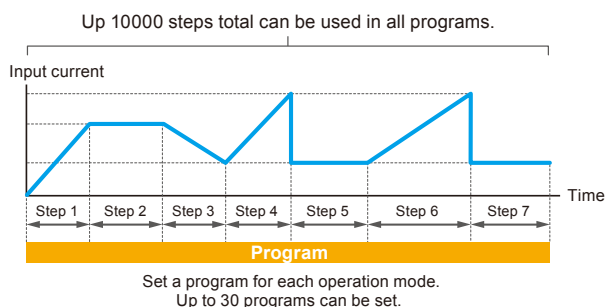

| Setting item | Description |
|--|---|
| Load setting | Current, conductance, voltage, power. The values that can be set depend on the current operation mode. |
| Step execution time | 0.000025s to 3600000s |
| Transition method of the current value | Step or Ramp |
| Number of loops of program | 1 to 100000 repetitions, or infinite repetitions. |
| Sequence editing / execution / stop method | Front panel operation or remote operation via RS232C / LAN / USB. |
| Miscellaneous | Load on/off control, Slew Rate, CV mode addition, Trigger signal setting, trigger signal output, Specifies the value at which a protection function (OCP, OPP, UVP) is activated. |

●TALink

The operator can use the TALink (Transient Acquire Link) trigger to synchronize the PLZ-5W with steps of a sequence and enable data logging. Logged data can then be accessed via digital communication with the PLZ-5W.

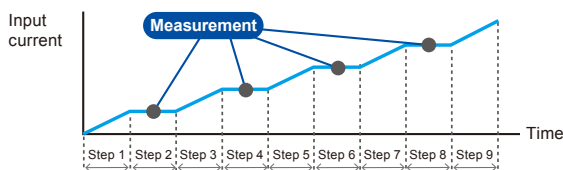

Remote sensing function

With remote sensing, the voltage measurement point can be changed from the load input terminal to the DUT sensing point. By connecting the sensing leads to the DUT, the effects of voltage drops caused by resistance in the load cables can be reduced and the load current stabilized. To activate remote sensing, connect the sensing cables to the sensing terminals of the PLZ-5W at the DUT end, and enable the remote sensing function.

- Possible remote sensing compensation voltage : approx. 7 V
(Total potential difference between the input terminals and sensing terminals)

Auto load off timer

The auto load off timer automatically turns off the load after a specific amount of time elapses from the discharge of the DUT. The integrated power and current is measured immediately after the load is turned off, ideal for battery discharge tests.

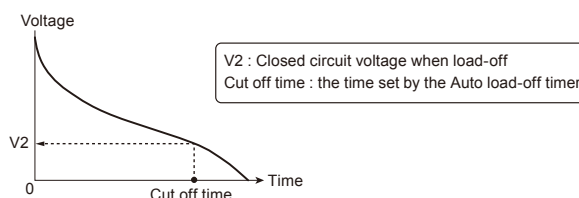

Synchronized operation

The following synchronization features are available when simply connecting the PLZ-5W with other equipment using a communication cable.

- Synchronizing load on/off among multiple pieces of equipment
- Synchronizing measurements (remote control)
- Synchronizing the start time and resume time for sequences across multiple units
Different PLZ-5W models can be connected (Ex: PLZ205W and PLZ1205W). Synchronization is also available during parallel operation.

Setup memory

The setup memory can store up to 20 sets of the settings listed below.

- Operation mode
- Load settings (current, conductance, voltage, power)
- Current range setting
- Voltage range setting
- Slew rate
- Switching level (current value/conductance value, or percentage)
- Switching interval (frequency/time of one cycle and duty cycle/operating time on the high side.)
- Alarm detection point
- Content of ABC preset memories

ABC preset memory

Three setting values can be stored in preset memory slots A, B, and C. The stored values can be recalled freely at any time even when the load is on. In CC+CV and CR+CV modes, constant current and constant voltage values, as well as constant resistance and constant voltage values can be recalled and saved, respectively.

Diverse protections, other functions

Overcurrent protection (OCP), Overpower protection (OPP), Overvoltage detection(OVP), Undervoltage protection (UVP), Overheat detection(OTP), Reverse-connection detection(REV), Alarm input detection, Configuration setting, USB Keyboard Compliant

Booster (PLZ2405WB)

*PLZ2405WB is a dedicated booster for PLZ1205W. It cannot be used with any other model.

Achieving 2400 W in a "2U" chassis

Connecting up to 4 booster (PLZ2405WB) units with the master (PLZ1205W) increases the maximum system capability to 10.8 kW 2160 A. The optional parallel cable (PC01-PLZ-5W) is required to connect between the master and slave/booster units.

- Increased power with optional booster units (Maximum currents and maximum voltages)

| Slave unit | 1 unit | 2 units | 3 units | 4 units |
|------------------|-----------------|------------------|------------------|-------------------|
| PLZ2405WB | 720 A 3600 W | 1200 A 6000 W | 1680 A 8400 W | 2160 A 10800 W |



Booster unit PLZ2405WB



[Configuration example]



▲ 3.6 kW system combined with the PLZ1205W (upper unit) and PLZ2405WB (lower unit).

- Comparison with the existing system when connecting 4 booster units.

Comparison with the PLZ4W SR Series

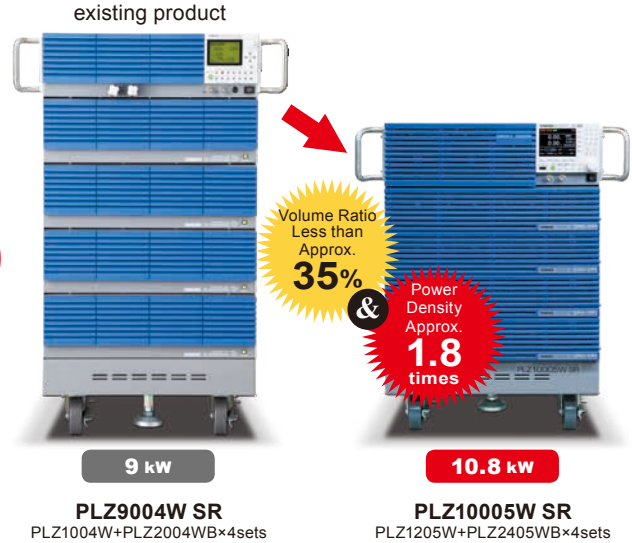

- Large-capacity systems of 10.8 kW or more, rack-mounted systems, and other types of systems are supported. For more information, please contact our sales representatives.

External dimensions (max): 430(440)W×86(105)H×450(505)Dmm
Weight: Approx. 15 kg (33.07 lb)

Parallel operation

Multiple units of the same type can be connected in parallel.

Even without boosters, up to five PLZ-5W units of the same model can be connected in parallel for a maximum of 6 kW, 1200 A. While connected in parallel, one master has complete control of the slave unit(s), allowing the user to control the entire system and monitor all data from the master unit's panel. Parallel operation requires one optional parallel cable (PC01-PLZ-5W) per unit.

*The PLZ2405WB (Booster) comes with 1 pc. of parallel operation cable (PC01-PLZ-5W).

- Number of parallel connected units and capacities (maximum currents and maximum voltages)

| Slave unit | 1 unit | 2 units | 3 units | 4 units |
|------------|-----------------|-----------------|-----------------|------------------|
| PLZ205W | 80 A 400 W | 120 A 600 W | 160 A 800 W | 200 A 1000 W |
| PLZ405W | 160 A 800 W | 240 A 1200 W | 320 A 1600 W | 400 A 2000 W |
| PLZ1205W | 480 A 2400 W | 720 A 3600 W | 960 A 4800 W | 1200 A 6000 W |

*Additional parallel operation calibration can achieve the same setting and measurement accuracy of a single unit.

● Connection example

Parallel operation using boosters (PLZ1205W only)

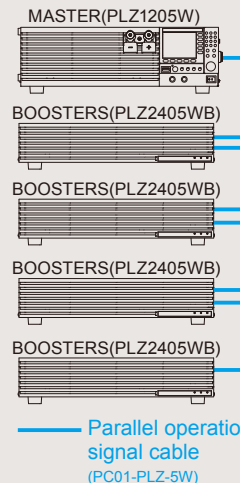

Parallel operation using the same type of electronic loads

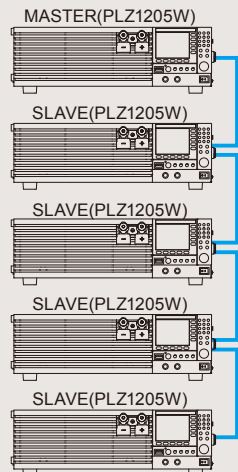

Impedance measurement function (factory option)

The perfect addition for battery production and maintenance

- The all-new PLZ-5WZ series allows for easily configured impedance measurements with dedicated impedance measurement software.
- Impedance measurements are made during discharge, allowing for real-time measurement of impedance values from the DUT.
- Capable of R, jX, θ , and Z measurements.
- Measures AC frequency from 100 Hz - 10 kHz (seven fixed settings) and signal levels can be set arbitrarily.
- Equipped with a voltage slope correction function that minimizes the effect of voltage slope during battery discharge tests.
- Zero adjustment function allows for increased accuracy during critical impedance measurements.
- Measurement results and graphical information can be copied directly from the application software to programs like Excel.

System configuration (example)

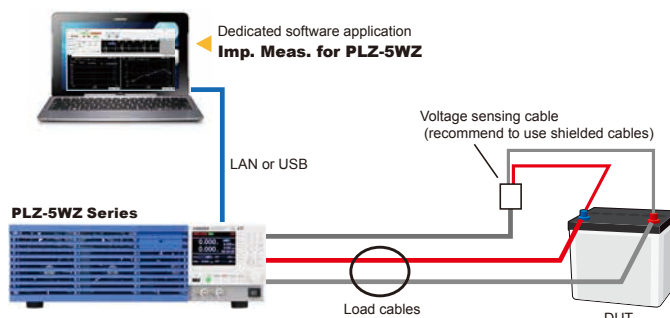

Lineup

| Model |
|-----------------------|
| PLZ205WZ (SPEC21192) |
| PLZ405WZ (SPEC21192) |
| PLZ1205WZ (SPEC21192) |

*High-capacity models are also available via special order.

Impedance measurement system PLZ-5WZ Series (SPEC21192)

Application software Imp. Meas. for PLZ-5WZ (accessory)



Measurement functions

| Item | Details | Conditions & remarks |
|-------------------------------------|---|--|
| Measurement AC frequency | 100 Hz, 200 Hz, 500 Hz, 1 kHz, 2 kHz, 5 kHz, 10 kHz | Seven fixed settings |
| Measurement AC current (Meas Curr.) | 0.1 % to 10 % of the DC load current (load curr.) | Set as a percentage |
| Measurement time | 50 ms to 5 s | Depends on the measurement AC frequency. |
| Measurement items | R, X, Z , θ | θ is calculated from R and X. |
| Measurement average | Averages 1 to 16 measured values. | Function available when using application |
| Zero adjustment (0 ADJ) | Zero adjustment on the DUT voltage sensing end | Function available when using application |
| V Slope Cancel | Eliminates the effect that the slope of the DUT voltage caused by discharge has on measurements | Complete elimination is not possible if the slope is nonlinear |
| Measurement method | 2-phase lock-in amplifier method | Based on digital computation. |
| Operating environment | Windows7/Windows10 (32 bit/64 bit) | |

Measurement condition diagram

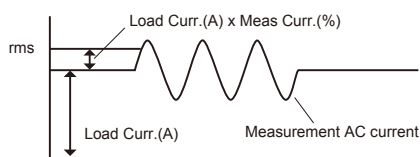

Impedance measurement for each single cell is also possible

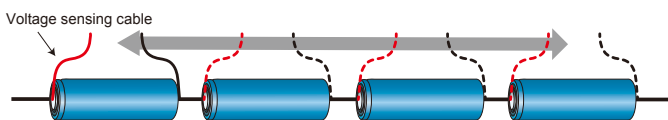

Measurement accuracy

- [Conditions] ■ Ambient temperature: 18°C to 28°C ■ DUT: Reference resistance ■ Bias power supply: 12 V 54 Ah lead battery
 ■ Measurement AC current: Depends on DUT impedance (refer to the following table).

● Voltage range at L range (15 V)

| Percentage of $\pm Z$ readout value | | Measurement AC frequency | | |
|---------------------------------------|------------------------|---------------------------------------|---------------------------------------|---------------|
| DUT impedance | Measurement AC current | 100 Hz, 200 Hz, 500 Hz | 1 kHz, 2 kHz | 5 kHz, 10 kHz |
| 1.0 m Ω to 9.9 m Ω | 500 mArms or more | $\pm(5\%$ of reading+0.5 m Ω) | $\pm(5\%$ of reading+0.5 m Ω) | — |
| 10.0 m Ω to 99.9 m Ω | 250 mArms or more | $\pm(5\%$ of reading+0.5 m Ω) | $\pm(5\%$ of reading+0.5 m Ω) | — |
| 100.0 m Ω to 1000.0 m Ω | 150 mArms or more | $\pm(2\%$ of reading+0.5 m Ω) | $\pm(3\%$ of reading+0.5 m Ω) | — |

● Voltage range at H range (150 V)

| Percentage of $\pm Z$ readout value | | Measurement AC frequency | | |
|---------------------------------------|------------------------|---------------------------------------|---------------------------------------|---------------|
| DUT impedance | Measurement AC current | 100 Hz, 200 Hz, 500 Hz | 1 kHz, 2 kHz | 5 kHz, 10 kHz |
| 1.0 m Ω to 9.9 m Ω | 2 Arms or more | $\pm(5\%$ of reading+0.5 m Ω) | $\pm(5\%$ of reading+0.5 m Ω) | — |
| 10.0 m Ω to 99.9 m Ω | 500 mArms or more | $\pm(5\%$ of reading+0.5 m Ω) | $\pm(5\%$ of reading+0.5 m Ω) | — |
| 100.0 m Ω to 1000.0 m Ω | 250 mArms or more | $\pm(3\%$ of reading+0.5 m Ω) | $\pm(4\%$ of reading+0.5 m Ω) | — |

*Accuracy of measurements outside the measurement range, L range current, and shaded portion is not guaranteed.

* θ is calculated from R and X by the application software. *Specifications not listed above are in accordance with PLZ-5W series product specifications.

Current sensor evaluation (example)

Accurate current sensor evaluation possible when combined with a high-precision CC DC power supply. Additionally, 3-level range settings allow you to.

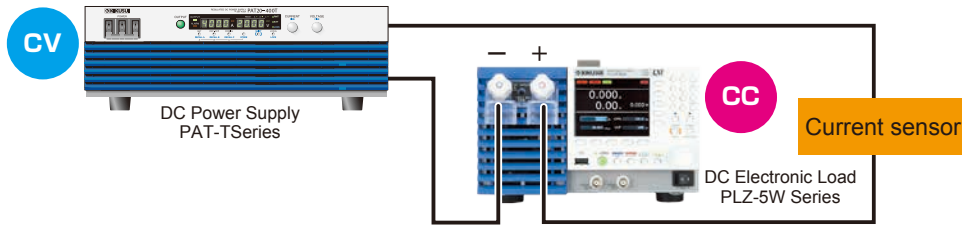

Power supply impedance measurement (example)

● Arbitrary I-V characteristics (ARB) mode

In ARB mode arbitrary I-V characteristics can be set by entering multiple I-V points (voltage and current value set points). 3 to 100 points can be registered and the spaces between all points are automatically linearly interpolated. This mode can be used for the simulation of LED drivers and other DUT's with non-linear characteristics.

■ Lighting LED lamp.....24 V, 48 V, 150 V

■ Lazer Diode.....4 V, 35 V, 60 V

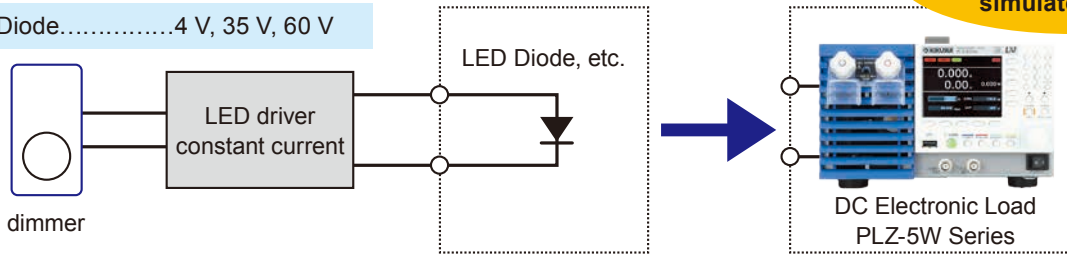

Impedance measurement of the power supply (example)

"When using the PLZ-5W"

Measure power supply impedance by configuring a system using the PLZ-5W, a function generator, and a digital multimeter.

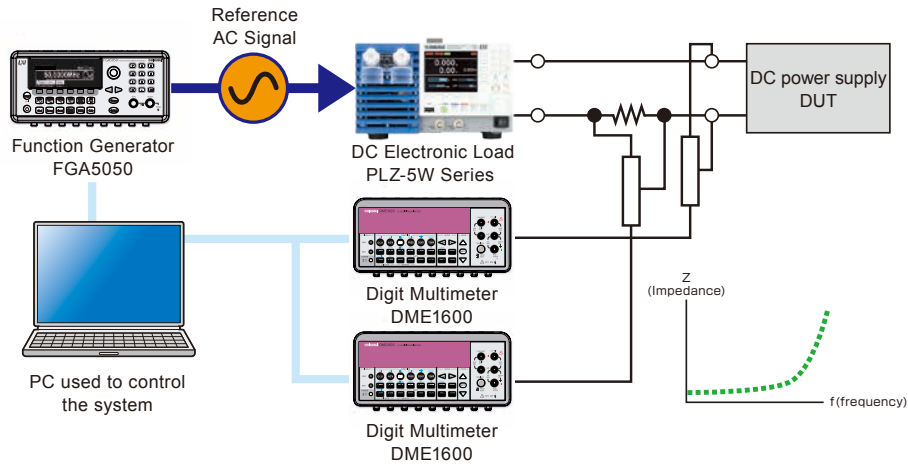

"When using the PLZ-5WZ"

A function generator is not necessary.

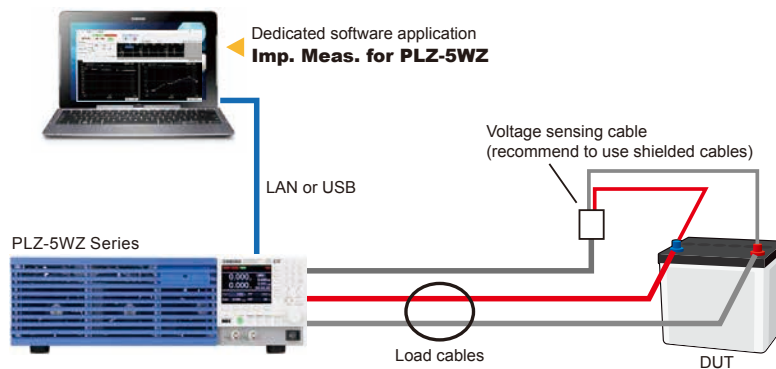

Fuse rupture test (example)

For fuse rupture tests, DC power supplies with high-speed CC current control is absolutely vital. Although it is normally quite difficult to achieve such high-speed control with only a DC power supply, the addition of a PLZ-5W electronic load makes high speed current control possible. With the PLZ-5W, fuse rupture tests that adhere to standards such as the JASO D612 are made possible. These tests include voltage drop tests, transient current cut-off tests, rupture time tests, step energization tests, and breaking capacity tests.

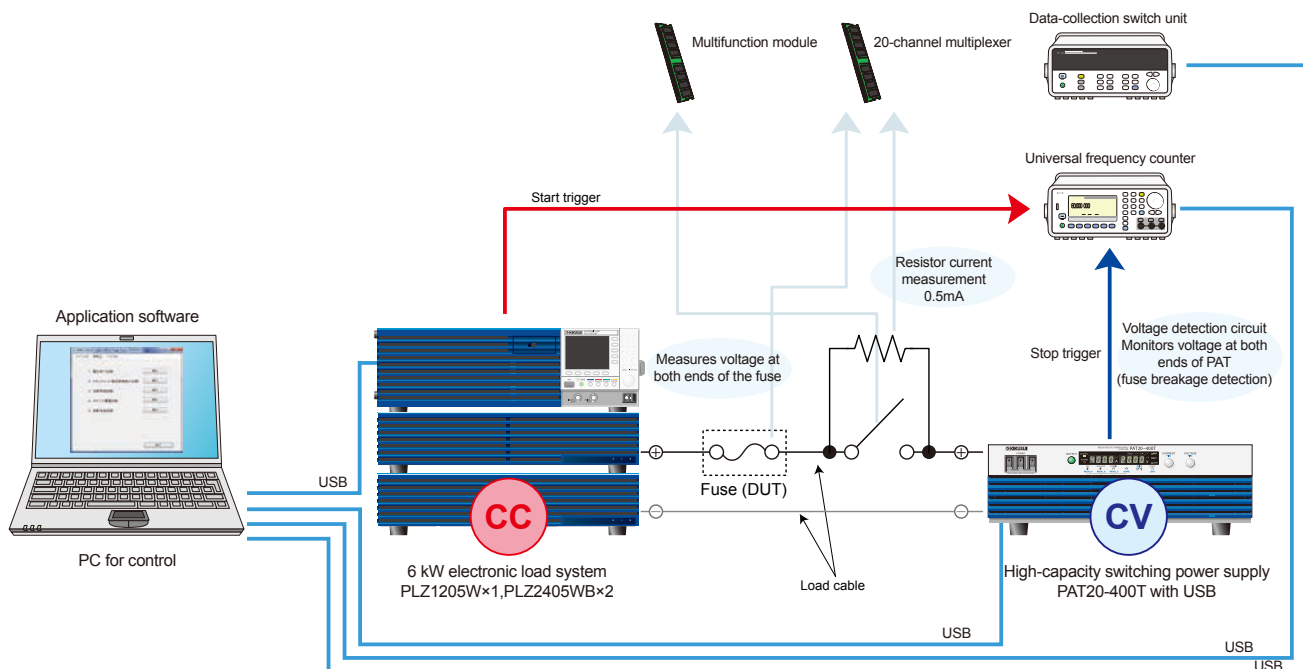

Battery evaluation test (example)

Although high-speed operation cannot be achieved using only the PAT-T high-capacity switching power supply, the fast-response unipolar power supply system can be supplemented by connecting with the PLZ-5W series electronic load in series and parallel. This makes it possible to flow current while synchronizing the charge and discharge current patterns for a battery at high speeds. Furthermore, the additional features of the PLZ-5WZ allow for seamless measurement of battery impedance during evaluation.

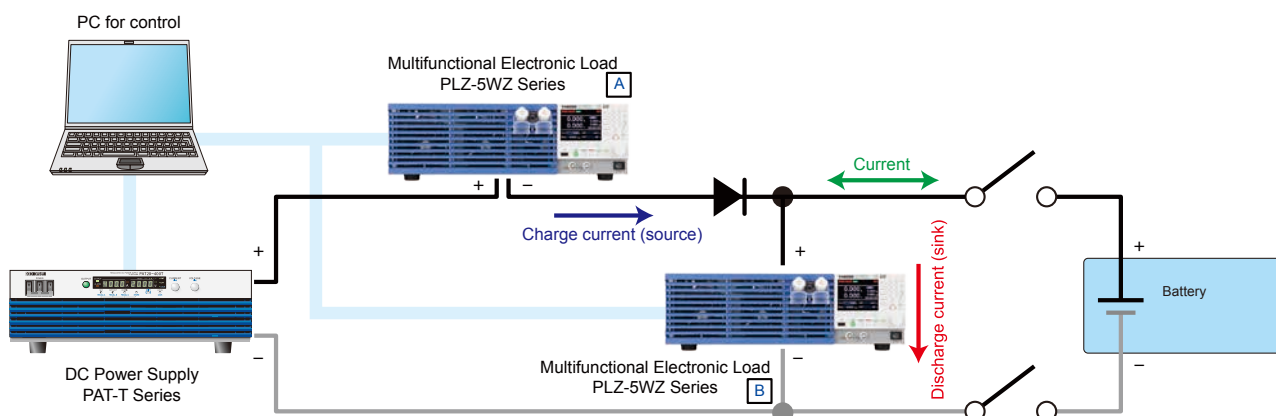

PLZ-5W SR (Smart Rack) Series

High Current
Max. **2160 A**
6 kW to 20.4 kW

The compact, large scale PLZ-5W SR (Smart Rack) system is available for high power applications that don't take up valuable test space.

- The system comes in 4 models ranging from 6 kW to 20.4 kW.
- Assembled with exclusive components for optimal design.
- Systems are delivered fully assembled and tested, ready to operate immediately.
- AC input 90 V to 250 V auto select; no special wiring is required.
- Range switching function guarantees the exact specification down to the smallest input.
(Performance test data is included)
- LAN/USB/RS232C as standard interface. *GPIB option
- Compatible with "Wavy" Sequence Creation Software.
- Load input terminal is designed for optimal safety.
- Load cable for high current is available.



PLZ20005W SR

20.4 kW



PLZ15005W SR

15.6 kW



PLZ10005W SR

10.8 kW



PLZ6005W SR

6 kW



Terminal Cover

Safety covers supplied on all models.

User-friendly terminal cover design for maximum safety and ease of access

Applications (example)

- Charge/Discharge test on the large capacity secondary battery
- Converter evaluation
- Alternator evaluation
- FC stack cell evaluation
- PV panel evaluation
- EV charger evaluation
- Heat generation evaluation by the harness electric conduction
- Capacitor endurance test
- Evaluation on the industrial large capacity DC power supply system

- The Smart Rack is safe, easy-to-use, and expertly designed.

Carrying handle



Input terminals capable of handling large currents

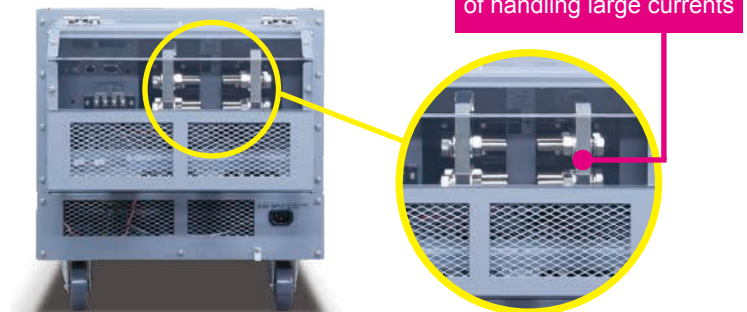

■ PLZ-5W SR Series

| Specifications | Rating | | | Constant current mode (CC) | | | | Constant voltage mode (CV) | | | |
|----------------|-------------------|---------|-------|----------------------------|-------------|-------------|--------|----------------------------|-------------|--------------|--------------|
| | Operating voltage | Current | Power | Operating range | | | Ripple | Operating range | | Resolution | |
| Model | V | A | W | H range (A) | M range (A) | L range (A) | mArms* | H range (V) | L range (V) | H range (mV) | L range (mV) |
| PLZ6005W SR | 1 to 150 | 1200 | 6000 | 0 to 1260 | 0 to 126 | 0 to 12.6 | 120 | 0 to 157.50 | 0 to 15.750 | 5 | 0.5 |
| PLZ10005W SR | | | | 0 to 2268 | 0 to 226.8 | 0 to 22.68 | 216 | | | | |
| PLZ15005W SR | | 2160 | 15600 | 0 to 3276 | 0 to 327.6 | 0 to 32.76 | 312 | | | | |
| PLZ20005W SR | | | 20400 | 0 to 4284 | 0 to 428.4 | 0 to 42.84 | 408 | | | | |

| Specifications | Constant resistance mode (CR) | | | Constant power mode (CP) | | | Weight | Power consumption |
|----------------|-------------------------------|-------------|-------------|--------------------------|-------------|-------------|---------|-------------------|
| | Operating range | | | Operating range | | | Approx. | Approx. |
| Model | H range (S) | M range (S) | L range (S) | H range (W) | M range (W) | L range (W) | kg | VA |
| PLZ6005W SR | 1260 to 0 | 126 to 0 | 12.6 to 0 | 0 to 6300 | 0 to 630 | 0 to 63.0 | 82 | 275 |
| PLZ10005W SR | 2268 to 0 | 226.8 to 0 | 22.68 to 0 | 0 to 11340 | 0 to 1134 | 0 to 113.4 | 120 | 465 |
| PLZ15005W SR | 3276 to 0 | 327.6 to 0 | 32.76 to 0 | 0 to 16380 | 0 to 1638 | 0 to 163.8 | 160 | 655 |
| PLZ20005W SR | 4284 to 0 | 428.4 to 0 | 42.84 to 0 | 0 to 21420 | 0 to 2142 | 0 to 214.2 | 200 | 855 |

* Measurement frequency bandwidth: 10 Hz to 1 MHz At measurement current of 100 A

■ High Current Load Wire (Solderless terminals on both ends.)

| Model | DC14-2P3M-M12M8 | DC38-2P3M-M12M8 | DC80-2P3M-M12M8 | DC80-2P3M-M12M12 | DC150-2P3M-M12M12 | DC150-4P3M-M12M12 | DC600-2P3M-M12M12 |
|------------------------------|--|--|--|--|---|---|--------------------------------|
| Maximum Allowable voltage | 650 V | | | | | | 150 V |
| Maximum Allowable current | 50 A | 100 A | 200 A | 200 A | 300 A | 500 A | 1000 A |
| Terminal | M12 / M8 | M12 / M8 | M12 / M8 | M12 / M12 | M12 / M12 | M12 / M12 | M12 / M12 |
| Nominal Cross-Sectional Area | 14 mm ² (Equivalent of AWG5) | 38 mm ² (Equivalent of AWG1) | 80 mm ² (Equivalent of AWG3/0) | 80 mm ² (Equivalent of AWG3/0) | 150 mm ² (Equivalent of AWG6/0) | 150 mm ² (Equivalent of AWG6/0) | 600 mm ² |
| Length / Weight *Per cable | Approx. 3 m / Approx. 0.5 kg | Approx. 3 m / Approx. 1.4 kg | Approx. 3 m / Approx. 2.8 kg | Approx. 3 m / Approx. 2.8 kg | Approx. 3 m / Approx. 5 kg | Approx. 3 m / Approx. 5 kg | Approx. 3 m / Approx. 20 kg |
| Exterior design | | | | | | | |

Outline drawing

■ Outline drawing

Unit: mm(inches)

| | | | |
|--------------|---------------------------------------|--------------|---------------------------------------|
| PLZ6005W SR | 433(17.04)W×370(14.56)H×640(25.19)Dmm | PLZ15005W SR | 433(17.04)W×748(29.44)H×640(25.19)Dmm |
| PLZ10005W SR | 433(17.04)W×567(22.32)H×640(25.19)Dmm | PLZ20005W SR | 433(17.04)W×930(36.61)H×640(25.19)Dmm |

● PLZ6005W SR

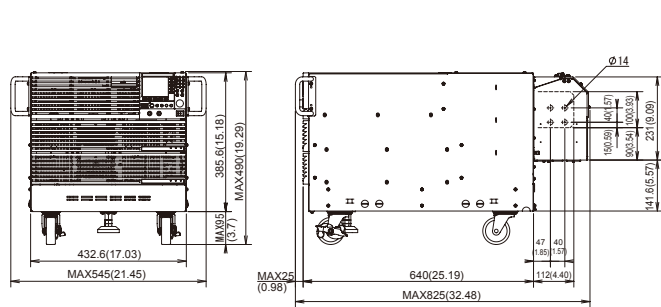

● PLZ10005W SR

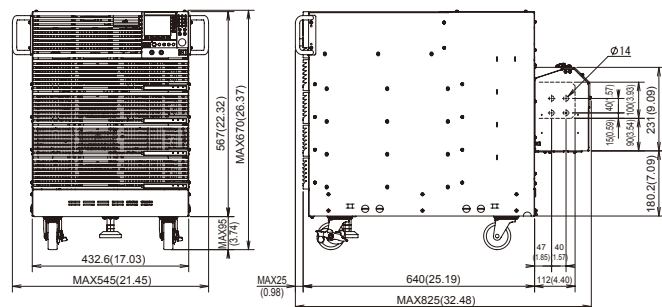

● PLZ15005W SR

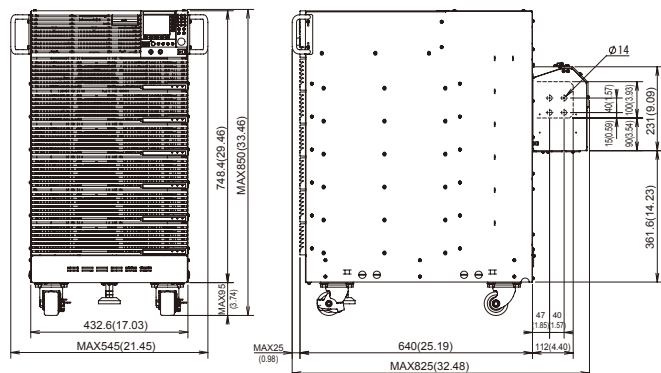

● PLZ20005W SR

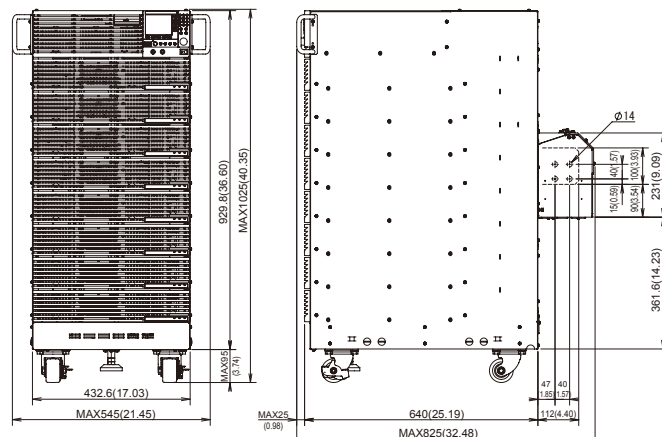

Unit: mm(inches)

PLZ205W/PLZ405W/PLZ1205W Specifications

| Ratings | | | |
|---|---|---------|----------|
| Item | PLZ205W | PLZ405W | PLZ1205W |
| Operating voltage (DC)*1 | 1 V to 150 V *2 | | |
| Current | 40 A | 80 A | 240 A *3 |
| Power | 200 W | 400 W | 1200 W |
| The minimum operating voltage | approximately 0.05 V. (At the load input terminals on the rear panel.) | | |
| Input resistance when the load is off | Approx. 660 kΩ *4 | | |
| Load input terminal's isolation voltage | ±500 V | | |

- *1 The voltage at which current starts flowing to the PLZ-5W is 0.05 V.
- *2 In switching mode, for every slow rate setting of 1 A/μs, the minimum operating voltage (including the voltage drop due to the wiring inductance component) increases by approx. 150 mV for the PLZ205W, approx. 125 mV for the PLZ405W, and approx. 75 mV for the PLZ1205W.
- *3 80 A for the load input terminals on the front panel.
The specifications of the PLZ-5W are for the load input terminals on the rear panel and the load input terminals on the front panel may not meet the specifications.
- *4 In the case of parallel operation using the same models, approx. 660/number of units kΩ.

| Constant current (CC) mode | | | | |
|----------------------------|---------|---------------------------------|---------------|---------------|
| Item | | PLZ205W | PLZ405W | PLZ1205W |
| Operating range | H range | 0 A to 40 A | 0 A to 80 A | 0 A to 240 A |
| | M range | 0 A to 4 A | 0 A to 8 A | 0 A to 24 A |
| | L range | 0 A to 0.4 A | 0 A to 0.8 A | 0 A to 2.4 A |
| Setting range | H range | 0 A to 42 A | 0 A to 84 A | 0 A to 252 A |
| | M range | 0 A to 4.2 A | 0 A to 8.4 A | 0 A to 25.2 A |
| | L range | 0 A to 0.42 A | 0 A to 0.84 A | 0 A to 2.52 A |
| Resolution | H range | 1 mA | 2 mA | 5 mA |
| | M range | 0.1 mA | 0.2 mA | 0.5 mA |
| | L range | 0.01 mA | 0.02 mA | 0.05 mA |
| Setting accuracy | H range | ± (0.2% of set + 0.1% of range) | | |
| | M range | ± (0.2% of set + 0.3% of range) | | |
| | L range | ± (0.2% of set + 1% of range) | | |
| Parallel operation | H range | ± (0.4% of set + 0.8% of range) | | |
| | M range | ± (0.4% of set + 0.8% of range) | | |
| | L range | ± (0.4% of set + 5% of range) | | |
| Input line regulation *1 | 4 mA | 8 mA | 24 mA | |
| Ripple | rms *2 | 4 mA | 8 mA | 24 mA |
| | p-p *3 | 40 mA | 80 mA | 200 mA |

- *1 When the input voltage is changed from 1 V to 150 V at a current of rated power / 150 V.
- *2 Measurement frequency bandwidth: 10 Hz to 1 MHz
- *3 Measurement frequency bandwidth: 10 Hz to 20 MHz

| Constant resistance (CR) mode | | | | |
|-------------------------------|---------|---|--|--|
| Item | | PLZ205W | PLZ405W | PLZ1205W |
| Operating range *1 | H range | 40 S to 0.002 S (0.025 Ω to 500 Ω) | 80 S to 0.004 S (0.125 Ω to 250 Ω) | 240 S to 0.012 S (0.0042 Ω to 83.333 Ω) |
| | M range | 4 S to 0.0002 S (0.25 Ω to 5000 Ω) | 8 S to 0.0004 S (0.125 Ω to 2500 Ω) | 24 S to 0.0012 S (0.042 Ω to 833.33 Ω) |
| | L range | 400 mS to 0.02 mS (2.5 Ω to 50000 Ω) | 800 mS to 0.04 mS (1.25 Ω to 25000 Ω) | 2400 mS to 0.12 mS (0.42 Ω to 8333.3 Ω) |
| Setting range | H range | 42 S to 0 S (0.0238 Ω to Open) | 84 S to 0 S (0.0119 Ω to Open) | 252 S to 0 S (0.00397 Ω to Open) |
| | M range | 4.2 S to 0 S (0.238 Ω to Open) | 8.4 S to 0 S (0.119 Ω to Open) | 25.2 S to 0 S (0.0397 Ω to Open) |
| | L range | 420 mS to 0 S (2.38 Ω to Open) | 840 mS to 0 S (1.19 Ω to Open) | 2520 mS to 0 S (0.397 Ω to Open) |
| Resolution | H range | 1 mS | 2 mS | 5 mS |
| | M range | 0.1 mS | 0.2 mS | 0.5 mS |
| | L range | 0.01 mS | 0.02 mS | 0.05 mS |
| Setting accuracy *2 | H range | ± (0.5% of set + 0.5% of range) | | |
| | M range | ± (0.5% of set + 0.5% of range) | | |
| | L range | ± (0.5% of set + 1.5% of range) | | |
| Parallel operation | H range | ± (0.5% of set + 1.5% of range) | | |
| | M range | ± (0.5% of set + 1.5% of range) | | |
| | L range | ± (0.5% of set + 5% of range) | | |

- *1 Conductance [S] = input current [A]/input voltage [V] = 1 / resistance [Ω]
- *2 Converted value at the input current. At the sensing terminals during remote sensing.

| Constant voltage (CV) mode | | | | |
|----------------------------|--------------------|---------------------------------|---------|----------|
| Item | | PLZ205W | PLZ405W | PLZ1205W |
| Operating range | H range | 1 V to 150 V | | |
| | L range | 1 V to 15 V | | |
| Setting range | H range | 0 V to 157.5 V | | |
| | L range | 0 V to 15.75 V | | |
| Resolution | H range | 5 mV | | |
| | L range | 0.5 mV | | |
| Setting accuracy *1 | Parallel operation | ± (0.1% of set + 0.1% of range) | | |
| | Parallel operation | ± (0.2% of set + 0.2% of range) | | |
| Input current variation *2 | | 12 mV | | |

- *1 With the input voltage within the operating range, and at the sensing terminals during remote sensing.
- *2 For a current change in the range of 10% to 100% of the rating at an input voltage of 5 V (during remote sensing).

| Constant power (CP) mode | | | | |
|--------------------------|---------|--|-----------------------------------|-----------------------------------|
| Item | | PLZ205W | PLZ405W | PLZ1205W |
| Operating range | H range | 20 W to 200 W | 40 W to 400 W | 120 W to 1200 W |
| | M range | 2 W to 20 W | 4 W to 40 W | 12 W to 120 W |
| | L range | 0.2 W to 2 W | 0.4 W to 4 W | 1.2 W to 12 W |
| Setting range | H range | 0 W to 210 W | 0 W to 420 W | 0 W to 1260 W |
| | M range | 0 W to 21 W | 0 W to 42 W | 0 W to 126 W |
| | L range | 0 W to 2.1 W | 0 W to 4.2 W | 0 W to 12.6 W |
| Resolution | H range | 0.005 W | 0.01 W | 0.05 W |
| | M range | 0.0005 W | 0.001 W | 0.005 W |
| | L range | 0.00005 W | 0.0001 W | 0.0005 W |
| Setting accuracy *1 | H range | ± (0.5% of range + 0.04 A × Vin) | ± (0.5% of range + 0.08 A × Vin) | ± (0.5% of range + 0.24 A × Vin) |
| | M range | ± (0.5% of range + 0.008 A × Vin) | ± (0.5% of range + 0.016 A × Vin) | ± (0.5% of range + 0.048 A × Vin) |
| | L range | ± (1% of range + 0.004 A × Vin) | ± (1% of range + 0.008 A × Vin) | ± (1% of range + 0.024 A × Vin) |
| Parallel operation | H range | ± (2% of range + 0.4% current range × Vin) | | |
| | M range | ± (2% of range + 0.4% current range × Vin) | | |
| | L range | ± (2% of range + 2.5% current range × Vin) | | |

- *1 Vin: Rear panel load input terminal voltage or sensing terminal voltage.

| Arbitrary I-V characteristics (ARB) mode | | | | |
|--|--------------------------|--|-------------------------------------|----------------------|
| Item | | PLZ205W | PLZ405W | PLZ1205W |
| Operating range | | Three to 100 points of current values can be set for the input voltage. The space between two points is linearly interpolated. | | |
| Response speed | | Response for input voltage minimum 50 μs. | | |
| Voltmeter | | | | |
| Item | | PLZ205W | PLZ405W | PLZ1205W |
| Display | H range | 0.00 V to 150.00 V | | |
| | L range | 0.000 V to 15.000 V | | |
| Accuracy | | ± (0.1% of reading + 0.1% of range) | | |
| | Parallel operation (TYP) | ± (0.1% of reading + 0.1% of range) | | |
| Ammeter | | | | |
| Item | | PLZ205W | PLZ405W | PLZ1205W |
| Display | H range | 0.000 A to 40.000 A | 0.000 A to 80.000 A | 0.00 A to 240.00 A |
| | M range | 0.0000 A to 4.0000 A | 0.0000 A to 8.0000 A | 0.000 A to 24.000 A |
| | L range | 0.00 mA to 400.00 mA | 0.00 mA to 800.00 mA | 0.0000 A to 2.4000 A |
| Accuracy | H, M range | ± (0.2% of reading + 0.3% of range) | | |
| | L range | ± (0.2% of reading + 1% of range) | | |
| | Parallel operation (TYP) | H, M range | ± (0.4% of reading + 0.8% of range) | |
| | L range | ± (0.4% of reading + 5% of range) | | |

| Power display | | | | |
|-----------------------------------|--|--|---------------------------|----------|
| Item | | PLZ205W | PLZ405W | PLZ1205W |
| Display | | Displays the product of the voltmeter reading and ammeter reading. | | |
| Switching function | | | | |
| Item | | PLZ205W | PLZ405W | PLZ1205W |
| Operation mode | | CC and CR | | |
| Frequency setting range | | 1.0 Hz to 100.0 kHz | | |
| Frequency setting resolution | | 1 Hz to 10 Hz..... | 0.1 Hz | |
| | | 11 Hz to 100 Hz..... | 1 Hz | |
| | | 110 Hz to 1000 Hz..... | 10 Hz | |
| | | 1.1 kHz to 10.0 kHz..... | 0.1 kHz | |
| | | 10 kHz to 100 kHz..... | 20 kHz, 50 kHz, 100 kHz | |
| Frequency setting accuracy | | ± (0.5% of set) | | |
| Duty cycle setting range, step *1 | | 1 Hz to 10 Hz..... | 5.0% to 95.0%, 0.1% steps | |
| | | 11 Hz to 100 Hz..... | 5.0% to 95.0%, 0.1% steps | |
| | | 110 Hz to 1000 Hz..... | 5.0% to 95.0%, 0.1% steps | |
| | | 1.1 kHz to 10.0 kHz..... | 5% to 95%, 1% steps | |
| | | 10 kHz to 100 kHz..... | 10% to 90%, 10% steps | |

- *1 The minimum time span is 5 us. The minimum duty cycle is limited by the minimum time span.

| Slow rate | | | | |
|---------------------|------------|--------------------------|--------------------------|--------------------------|
| Item | | PLZ205W | PLZ405W | PLZ1205W |
| Operation mode | | CC | | |
| Setting range | H range | 0.01 A/ μs to 10 A/ μs | 0.02 A/ μs to 20 A/ μs | 0.06 A/ μs to 60 A/ μs |
| | M range | 0.001 A/ μs to 1 A/ μs | 0.002 A/ μs to 2 A/ μs | 0.006 A/ μs to 6 A/ μs |
| | L range | 0.1 mA/ μs to 100 mA/ μs | 0.2 mA/ μs to 200 mA/ μs | 0.6 mA/ μs to 600 mA/ μs |
| Resolution | H range | 0.01 A/ μs | 0.02 A/ μs | 0.06 A/ μs |
| | L range | 0.001 A/ μs | 0.002 A/ μs | 0.006 A/ μs |
| Setting accuracy *1 | H, M range | ± (10% of set + 1.25 μs) | | |
| | L range | ± (12% of set + 5 μs) | | |

- *1 Time to change from 10% to 90% when the current is changed from 0% to 100% of the rated current

| Soft start | | | | |
|-----------------------|--|--|---------|----------|
| Item | | PLZ205W | PLZ405W | PLZ1205W |
| Operation mode | | CC | | |
| Time setting range | | 100 μs, 200 μs, 500 μs, 1 ms, 2 ms, 5 ms, 10 ms, 20 ms, or off | | |
| Time setting accuracy | | ± (30% of set + 10 μs) | | |

PLZ205W/PLZ405W/PLZ1205W Specifications

| Possible remote sensing compensation voltage | | | | |
|--|---|--|---|------------------|
| Item | PLZ205W | PLZ405W | PLZ1205W | |
| Approx. 7 V (total potential difference between the input terminals and sensing terminals). | | | | |
| Protective function | | | | |
| Item | PLZ205W | PLZ405W | PLZ1205W | |
| Overcurrent protection (OCP) | Setting range | 0.0 A to 44.0 A | 0.0 A to 88.0 A | 0.0 A to 264.0 A |
| | Resolution | 10 mA | 10 mA | 10 mA |
| | Protection operation | Either load off or limitation can be selected. | | |
| Overpower protection (OPP) | Setting range | 0 W to 220 W | 0 W to 440 W | 0 W to 1320 W |
| | Resolution | 0.1 W | 0.1 W | 0.1 W |
| | Protection operation | Either load off or limitation can be selected. | | |
| Undervoltage protection (UVP) | Setting range | 0.00 V to 150.00 V, or off | | |
| | Resolution | 0.01 V | | |
| | Protection operation | Load off | | |
| Watchdog protection (WDP) | Setting range | 1 s to 3600 s or off | | |
| | Protection operation | Load off | | |
| EXT CONT connector | | | | |
| Item | PLZ205W | PLZ405W | PLZ1205W | |
| Load on/off control input | Logic level switchable. Pulled up to 5 V by a 10 kΩ resistor. The thresholds are HIGH: 3.5 V to 5 V, LOW: 0 V to 1.5 V. | | | |
| Range control input | The range can be switched between L, M, and H using a 2 bit signal. Pulled up to 5 V by a 10 kΩ resistor. The thresholds are HIGH: 3.5 V to 5 V, LOW: 0 V to 1.5 V. | | | |
| Alarm input | An alarm is activated with a voltage between 0 V and 1.5 V. Pulled up to 5 V by a 10 kΩ resistor. The thresholds are HIGH: 3.5 V to 5 V, LOW: 0 V to 1.5 V. | | | |
| Alarm clearing input | After an alarm occurs, eliminate the root cause of the alarm, and change the input to pin 5 of the EXT CONT connector from a low level signal to a high level signal. The alarm will be cleared on the rising edge of this signal. Pulled up to 5 V by a 10 kΩ resistor. The thresholds are HIGH: 3.5 V to 5.0 V, LOW: 0 V to 1.5 V. | | | |
| Trigger input | Paused sequence operation resumes when a voltage between 0 V and 0.8 V is received. Pulled up to 5 V by a 10 kΩ resistor. The thresholds are HIGH: 2 V to 5 V, LOW: 0 V to 0.8 V. | | | |
| External voltage control input (CC, CR, CP mode) | Controls the load settings of CC, CR, CP mode through external voltage input. The input impedance is approx. 10 kΩ. CC: The setting can be controlled in the range of 0% to 100% of the rated current through external voltage input of 0 V to 10 V. CR: The setting can be controlled in the range of 0% to 100% of the conductance setting through external voltage input of 0 V to 10 V. CP: The setting can be controlled in the range of 0% to 100% of the rated power through external voltage input of 0 V to 10 V. | | | |
| | Setting accuracy | ± (1% of range) (TYP value of H range in CC mode) | | |
| External voltage control input (CV mode) | The load setting of CV mode can be controlled through external voltage input. The rated voltage can be controlled in the range of 0% to 100% with 0 V to 10 V. The input impedance is approx. 10 kΩ. | | | |
| | Setting accuracy | ± (1% of range) (TYP value) | | |
| External voltage control input (superimposing in CC mode) | Controls the load setting of CC mode by adding current through external voltage input. Adds current in the range of -100% to 100% of the rated current for -10 V to 10 V. The input impedance is approx. 10 kΩ. | | | |
| | Setting accuracy | ± (1% of range) (TYP value of H range) | | |
| Load-on status output | On when load is on. Open-collector output from a photocoupler. *1 | | | |
| Range status output | Outputs current range state L, M, and H using 2 bits. Open-collector output from a photocoupler. *1 | | | |
| ALARM 1 output | Turns on when overvoltage detection, reverse-connection detection, overheat detection, alarm input detection, front-panel load input terminal overcurrent detection, or parallel operation anomaly detection is activated. Open-collector output from a photocoupler. *1 | | | |
| ALARM 2 output | Turns on when OCP, OPP, UVP, or WDP is activated. | | | |
| DIGITAL 0 / DIGITAL 1 output | Logic signal output during a step of a sequence. Output impedance: approx. 330 Ω, output voltage: approx. 3.3 V _{EMF} | | | |
| DIGITAL 2 output | Input/output switchable. | | | |
| | Output: Logic signal output during a step of a sequence. The output impedance is 330 Ω. Input: Trigger input signal for the sequence and the measurement functions. The thresholds are HIGH: 2 V to 5 V, LOW: 0 V to 0.8 V. | | | |
| Current monitor output | Outputs 0 V to 10 V for 0% to 100% of the rated current of each range. | | | |
| | Accuracy | ± (1% of range) (TYP value of H range) | | |
| Short signal output | Relay contact turns on when the short function is turned on (30 Vdc/1 A). | | | |
| *1 The maximum voltage that can be applied to the photocoupler is 30 V. The maximum current is 4 mA. | | | | |
| BNC connector | | | | |
| Trigger output | Transmits 10 μs pulses when trigger output is ON during sequence operation and during step execution. Transmits 1 μs pulses during switching operation. | | | |
| Current monitor output | Outputs 0 V to 2 V for 0% to 100% of the rated current of each range. | | | |
| | Accuracy | ± (1% of range) (TYP value of H range) | | |
| Isolation voltage | ±30 V | | | |
| Communication function | | | | |
| LAN | IEEE 802.3 10Base-TX / 10Base-T Ethernet IPv4, RJ-45 connector | | | |
| RS232C | D-SUB 9-pin connector Baud rate: 9600, 19200, 38400, 115200 bps Data length: 8 bits, Stop bits: 1 bit, Parity bit: None, Flow control: None, CTS-RTS | | | |
| USB | Complies with the USB 2.0 specification. Data rate: 480 Mbps (High speed) Complies with the USB MC-USB488 device class specifications. | | | |
| General specifications | | | | |
| Input voltage range/ Input frequency range | 100 Vac to 240 Vac (90 Vac to 250 Vac) single phase, continuous / 47 Hz to 63 Hz | | | |
| Power consumption | 50 VAmax | 50 VAmax | 85 VAmax | |
| Inrush current (peak value) | 45 Apeak | | | |
| Environmental conditions | Operating temperature range | 0 °C to 40 °C (32 °F to 104°F) | | |
| | Operating humidity range | 20%rh to 85%rh (no condensation) | | |
| | Storage temperature range | -20 °C to 70 °C (-4 °F to 158°F) | | |
| | Storage humidity range | 90%rh or less (no condensation) | | |
| | Installation location | Indoor use, altitude of up to 2000 m, overvoltage category II. | | |
| Insulation resistance | Between primary and input terminals | 500 Vdc, 30 MΩ or more (70%rh or less) | | |
| | Between primary and chassis | | | |
| | Between input terminals and chassis | | | |
| Withstanding voltage | Between primary and input terminals | No abnormalities at 1500 Vac for 1 minute. | | |
| | Between primary and chassis | No abnormalities at 1500 Vac for 1 minute. | | |
| | Between input terminals and chassis | No abnormalities at 750 Vac for 1 minute. | | |
| Dimensions | Unit: mm (inches) | 214.5 (8.45)W×124 (4.88)H×400 (15.75)Dmm(inches) | 429.5 (16.91)W×128 (5.04)H×400 (15.75)Dmm(inches) | |
| Weight | | Approx. 7 kg (15.4 lb.) | Approx. 7.5 kg (16.5 lb.) Approx. 14 kg (30.9 lb.) | |
| Accessories | Power cord, Rear-panel load input terminal cover, Load input terminal screw set (2 sets), Screws for the rear-panel load input terminal cover (2 pcs.), Front-panel load input terminal cover, Front-panel load input knob set, External control connector kit, Setup Guide, CD-ROM, Quick Reference, Safety Information | | | |
| Electromagnetic compatibility (EMC) *1 *2 | Complies with the requirements of the following directive and standards. EMC Directive 2014/30/EU, EN 61326-1 (Class A*3), EN 55011 (Class A*3, Group 1*4), EN 61000-3-2, EN 61000-3-3 Applicable under the following conditions. The maximum length of all cabling and wiring connected to the PLZ-5W must be less than 3 m. | | | |
| Safety *1 | Complies with the requirements of the following directive and standards. Low Voltage Directive 2014/35/EU*2 EN 61010-1 (Class I*5, Pollution Degree 2*6) | | | |

*1 Does not apply to specially ordered or modified PLZ-5Ws. *2 Limited to products that have the CE mark on their panels. *3 This is a Class A equipment. This product is intended for use in an industrial environment. This product may cause interference if used in residential areas. Such use must be avoided unless the user takes special measures to reduce electromagnetic emissions to prevent interference to the reception of radio and television broadcasts. *4 This is a Group 1 equipment. This product does not generate and/or use intentionally radio-frequency energy, in the form of electromagnetic radiation, inductive and/or capacitive coupling, for the treatment of material or inspection/analysis purpose. *5 This is a Class I equipment. Be sure to ground this product's protective conductor terminal. The safety of this product is only guaranteed when the product is properly grounded. *6 Pollution is addition of foreign matter (solid, liquid or gaseous) that may produce a reduction of dielectric strength or surface resistivity. Pollution Degree 2 assumes that only non-conductive pollution will occur except for an occasional temporary conductivity caused by condensation.

PLZ2405WB Specifications

| Ratings | | |
|--|---|---|
| Item | PLZ2405WB | |
| Operating voltage | 1 Vdc to 150 Vdc | |
| Current | 480 A | |
| Power | 2400 W | |
| Current range | | |
| H range | 0 A to 480 A | |
| M range | 0 A to 48 A | |
| L range | 0 A to 4.8 A | |
| Setting accuracy | | |
| CC mode | H range | ± (0.4% of set + 0.8% of range) |
| | M range | ± (0.4% of set + 0.8% of range) |
| | L range | ± (0.4% of set + 5% of range) |
| CR mode | H range | ± (0.5% of set + 1.5% of range) |
| | M range | ± (0.5% of set + 1.5% of range) |
| | L range | ± (0.5% of set + 5% of range) |
| CV mode | H,M,L range | ± (0.2% of set + 0.2% of range) |
| CP mode | H range | ± (2% of range + 0.4% current range × Vin ^{*1}) |
| | M range | ± (2% of range + 0.4% current range × Vin ^{*1}) |
| | L range | ± (2% of range + 2.5% current range × Vin ^{*1}) |
| Measurement accuracy | | |
| Voltmeter accuracy ± (0.1% of reading + 0.1% of range) | | |
| Ammeter accuracy | H range | ± (0.4% of reading + 0.8% of range) |
| | M range | ± (0.4% of reading + 0.8% of range) |
| | L range | ± (0.4% of reading + 5% of range) |
| Protection functions | | |
| Over temperature protection (OTP) | Turns off the load when the heatsink temperature reaches 100 °C | |

*1 Vin: Load input terminal voltage or sensing terminal voltage.

| General specifications | | |
|----------------------------------|---|--|
| Item | PLZ2405WB | |
| Input power supply voltage range | 100 Vac to 240 Vac (90 Vac to 250 Vac) single-phase, continuous | |
| Input frequency range | 47 Hz to 63 Hz | |
| Power consumption | 95 VAmx | |
| Inrush current (peak value) | 45 Apeak | |
| Operating temperature range | 0 °C to 40 °C (32 °F to 104 °F) | |
| Operating humidity range | 20%rh to 85%rh (no condensation) | |
| Storage temperature range | -20 °C to 70 °C (-4 °F to 158 °F) | |
| Storage humidity range | 90%rh or less (no condensation) | |
| Installation location | Indoor use, altitude of up to 2000 m, overvoltage category II | |
| Isolation voltage | ±500 V | |
| Insulation resistance | Between primary and input terminals | 500 Vdc 30 MΩ or greater (at 70%rh humidity or less) |
| | Between primary and chassis | |
| | Between input terminals and chassis | |
| Withstanding voltage | Between primary and input terminals | No abnormalities at 1500 Vac for 1 minute |
| | Between primary and chassis | No abnormalities at 1500 Vac for 1 minute |
| | Between input terminals and chassis | No abnormalities at 750 Vdc for 1 minute |
| External dimensions | 430(16.93)W×86(3.39)H×450(17.72)Dmm(inches) | |
| Weight | Approx. 15 kg (33.07 lb) | |
| Accessories | Power cord, Load input terminal cover, Parallel operation signal cable kit (PC01-PLZ-5W), Load input terminal screw set (2 sets), Screws for the load input terminal cover (2 pcs.), Operation manual | |

Outline drawing

●PLZ205W, PLZ405W

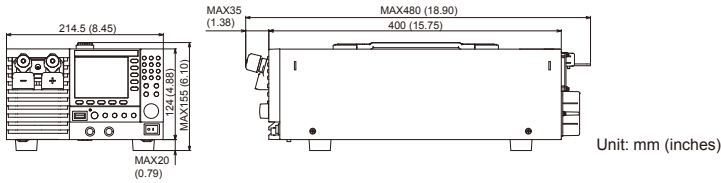

●PLZ1205W

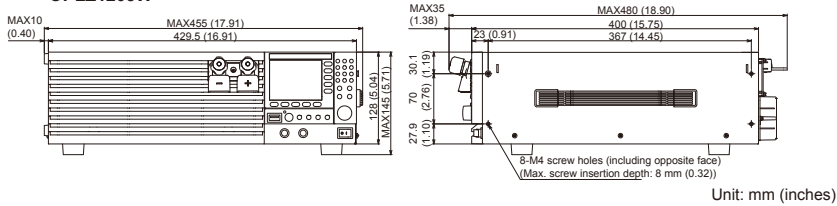

●PLZ2405WB

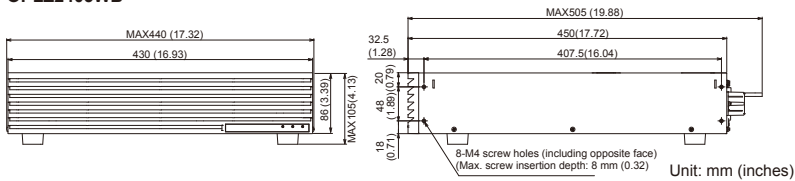

Sequence creation and control software

SD023-PLZ-5W (Wavy for PLZ-5W)

Make the Kikusui power supplies and electronic load more intelligent!

Expand the ideas of engineers with the sequence creation and control software " Wavy "

[Operating environment] Windows 7 / 10

The SD023-PLZ-5W (Wavy for PLZ-5W) is an application software designed for sequence creation and operation of Kikusui's PLZ-5W series of DC electronic loads. It allows users to freely carry out sequence control of power supplies and electronic loads without any programming knowledge. Users can easily edit sequences as if drawing a picture or working on a spreadsheet.

- Able to easily create and edit sequence functions using a mouse.
- Execution positions are visually displayed during sequence execution.
- Monitors voltage and current, which can be saved into files.
- Monitor data displayed in real time as a monitor graph.

A trial version of Wavy is available!

Download!

Can be used for three weeks without any function limitations.

<http://www.kikusui.co.jp/download/index.html>

Set up steps by drawing with a mouse in the graph window.

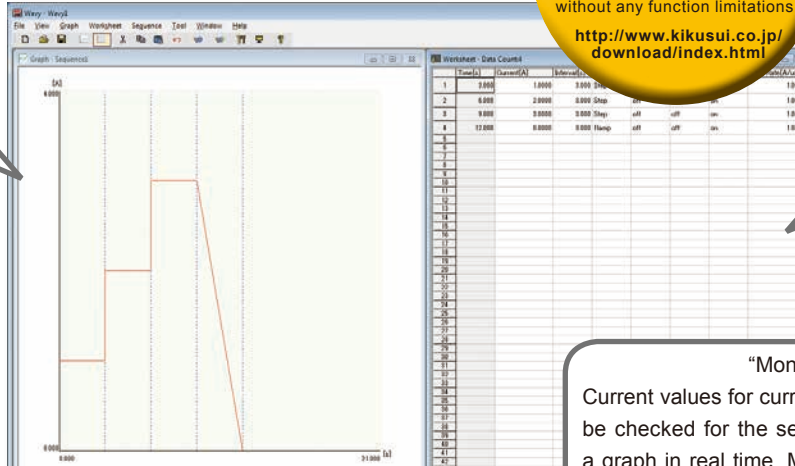

Set a step by inputting values and conditions in the sequence window.

"Setting graph" Cursor indication of operation status on the setting graph.

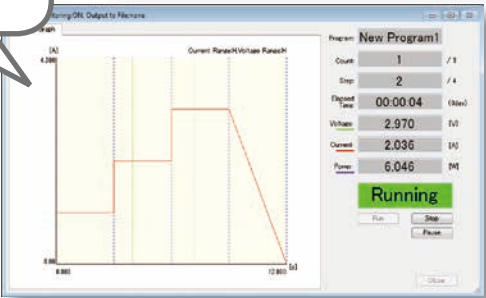

"Monitor graph" Current values for current, voltage, and power can be checked for the sequence being executed on a graph in real time. Monitor data is displayed by placing the mouse cursor on the graph.

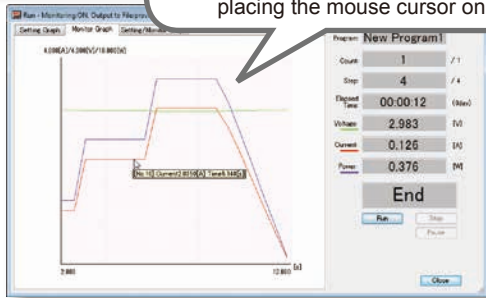

"Arbitrary I-V characteristics (ARB) mode" In the arbitrary I-V characteristics (ARB) mode, desired I-V characteristics can be set by specifying multiple arbitrary points of I-V characteristics (as sets of voltage and current values).

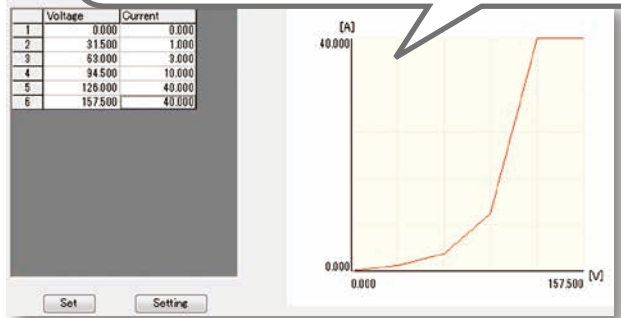

"Direct control window" Directly control PLZ-5W in a manner similar to using a remote control. In addition, monitoring and logging of output are also possible.

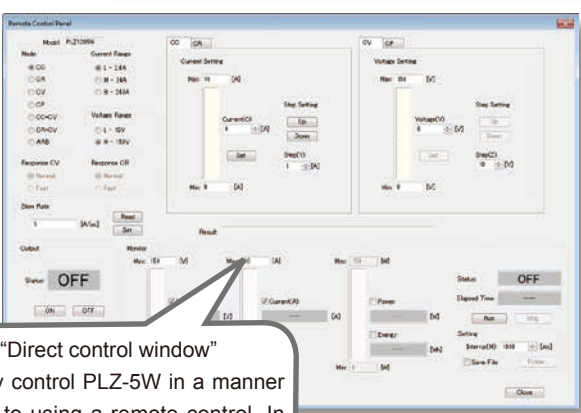

GPIB converter (PIA5100)

This converter converts RS232C or USB of the PLZ-5W to GPIB, enabling connection of a remote controller using GPIB.
[Accessories: Power cord set, Magnetic sheet]



[Connection example]

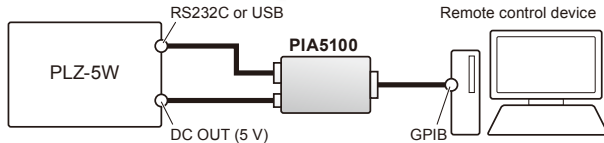

Parallel operation signal cable kit (PC01-PLZ-5W)

One cable required for each slave/booster unit.
Cable length : 30cm

*The PLZ2405WB (Booster) comes with 1 pc. of parallel operation cable (PC01-PLZ-5W).



Rack adapters, brackets

These are rack mounting options.

Rack adapter

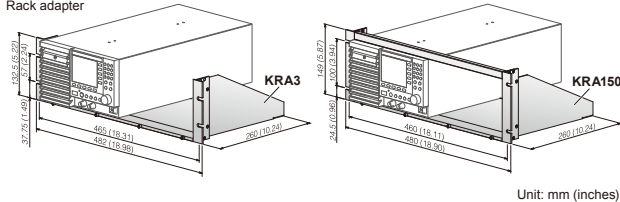

Unit: mm (inches)

Bracket

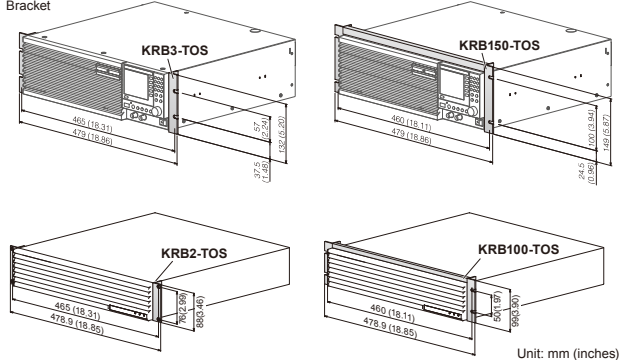

Unit: mm (inches)

| Name | Model | Appropriate Model | Description |
|---------------------|------------|-------------------|--------------------------|
| Rack adapters *1 | KRA3 | PLZ205W | For EIA inch racks |
| | KRA150 | PLZ405W | For JIS millimeter racks |
| Bracket | KRB3-TOS | PLZ1205W | For EIA inch racks |
| | KRB150-TOS | | For JIS millimeter racks |
| | KRB2-TOS | PLZ2405WB | For EIA inch racks |
| | KRB100-TOS | | For JIS millimeter racks |

*1 When using blank panels for rack adapters, please use KBP3-2.



KIKUSUI ELECTRONICS CORPORATION

Southwood 4F,6-1 Chigasaki-chuo,Tsuzuki-ku,Yokohama,224-0032,Japan
Phone: (+81)45-482-6353,Facsimile: (+81)45-482-6261,www.kikusui.co.jp

KIKUSUI AMERICA, INC. 1-310-214-0000 www.kikusuiamerica.com



3625 Del Amo Blvd, Suite 160, Torrance, CA 90503
Phone: 310-214-0000 Facsimile: 310-214-0014

KIKUSUI TRADING (SHANGHAI) Co., Ltd. www.kikusui.cn



Room 305,Shenggao Building ,No.137,Xianxia Road, Shanghai City, China
Phone : 021-5887-9067 Facsimile : 021-5887-9069

For our local sales distributors and representatives, please refer to "sales network" on our website.

●Distributor:

■ All products contained in this catalogue are equipment and devices that are premised on use under the supervision of qualified personnel, and are not designed or produced for home-use or use by general consumers. ■ Specifications, design and so forth are subject to change without prior notice to improve the quality. ■ Product names and prices are subject to change and production may be discontinued when necessary. ■ Product names, company names and brand names contained in this catalogue represent the respective registered trade name or trade mark. ■ Colors, textures and so forth of photographs shown in this catalogue may differ from actual products due to a limited fidelity in printing. ■ Although every effort has been made to provide the information as accurate as possible for this catalogue, certain details have unavoidably been omitted due to limitations in space. ■ If you find any misprints or errors in this catalogue, it would be appreciated if you would inform us. ■ Please contact our distributors to confirm specifications, price, accessories or anything that may be unclear when placing an order or concluding a purchasing agreement.

Printed in Japan

Issue: Sep 2020

202009PDFEC41