

**High-speed and variable integration time DMM supporting multiple applications**

- Two models by use  
6½-digit display (7461A)  
5½-digit display (7451A)
- Fast sampling : 20,000 readings/sec (7461A)  
5,000 readings/sec (7451A)
- Variable integration time: 10µs to 10s (7461A), 100µs to 10s (7451A)
- High-resolution DCI measurement: 1nA (7461A), 10nA (7451A)
- Two-channel DCV measurement
- Full array of trigger functions

**5½  
digits**

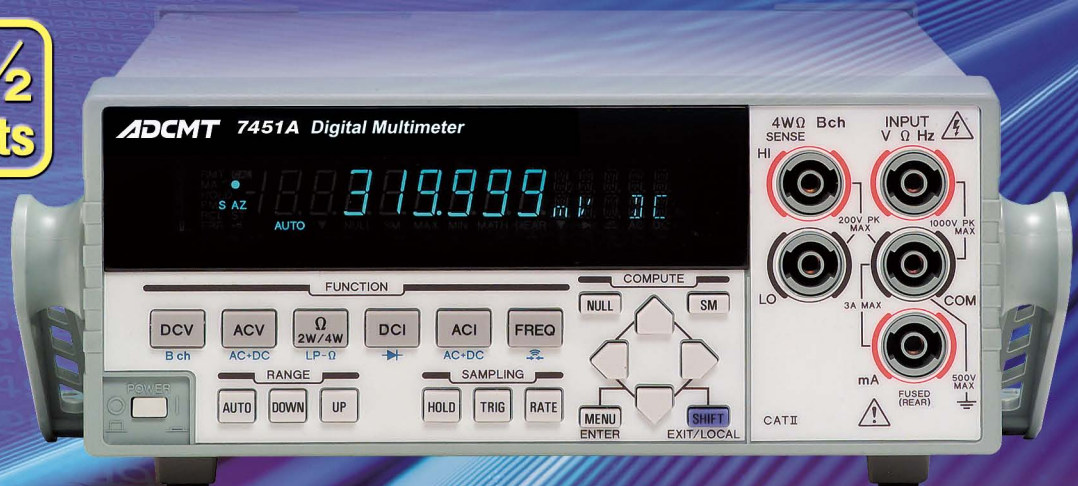

**6½  
digits**



# New Measurement Stage with Variable Integration Time

## 6½-digit (7461A) and 5½-digit (7451A) digital multimeters Achieve both high performance and low price

The 7461A and the 7451A are digital multimeters with 6½-digit and 5½-digit display respectively, providing high performance with low price.

These multimeters realize high-speed sampling performance with selective sampling modes by adopting the newly developed A/D converter, supporting a variety of applications including digitization of pulse signals, logging measurement at certain intervals.

As another feature, the integration time can be set to any values. This enables correctly measuring the average values of pulsed current/voltage, which cannot be measured by former models.

In addition to the conventional external trigger functions, extensive internal trigger functions have been added, allowing easy capturing of the measured data.

Furthermore, these multimeters are provided with two-channel DC voltage measurement (Bch 10V range fixed), so that low cost measurement system architecture is available.

Since both GPIB and USB interfaces are mounted as standard, it is easy to capture data, extending the support to automated production lines and other applications.



GPIB

USB

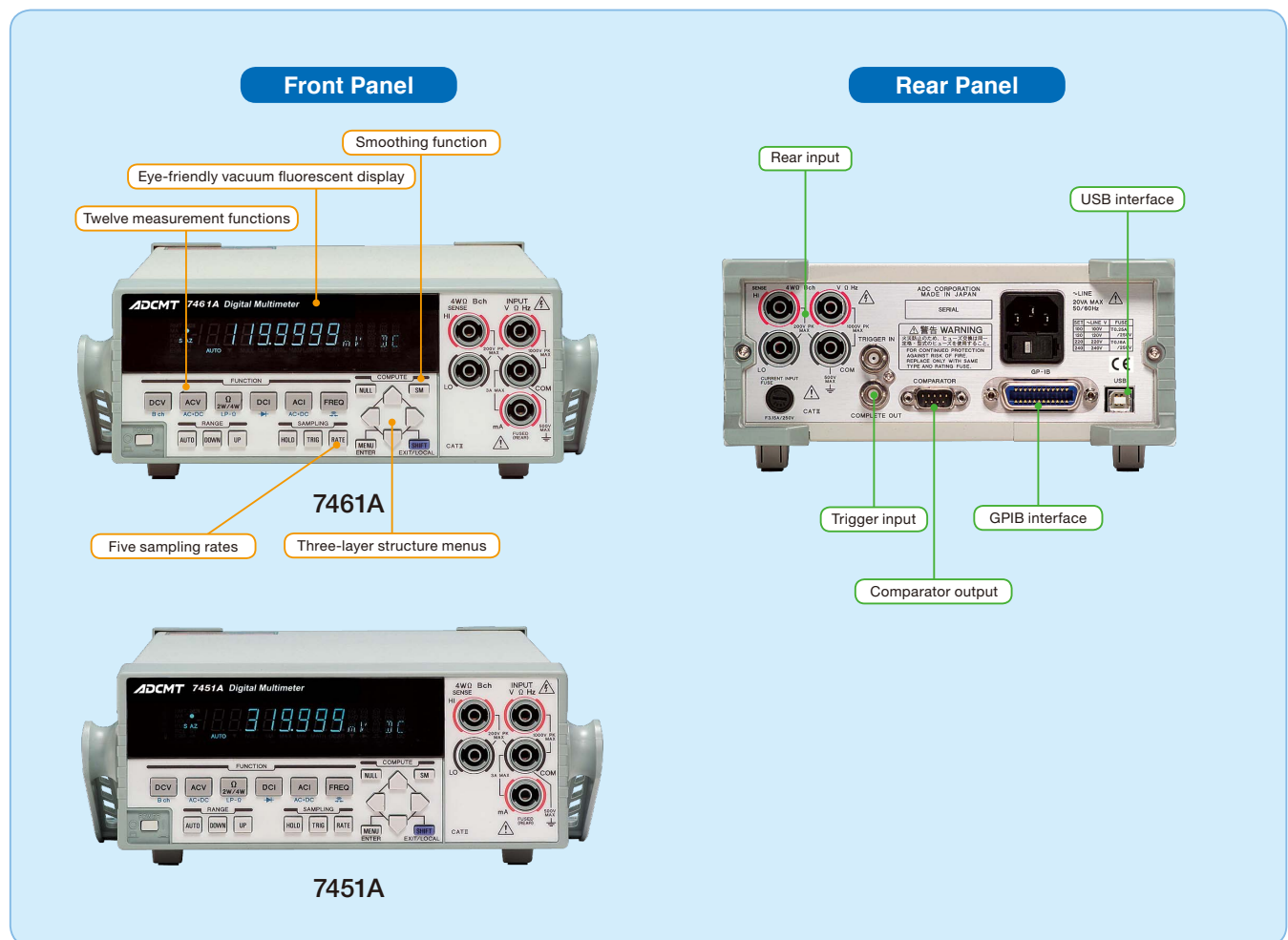

## High Speed Sampling

By adopting the newly developed variable integration time A/D converter, the 7461A and the 7451A realize the highest sampling rate of 20,000 readings per sec and 5,000 readings per sec with 3½-digit resolution respectively. The sampling interval can be set from 50µs to 3,600s for the 7461A, and from 200µs to 3,600s for the 7451A, which allows high-speed digitization and data logging at precise measurement intervals.

Function		7461A	7451A
Maximum sampling rate	Memory	20,000	5,000
	GPIOB	1,000	1,000
Integration time		10µs to 10s	100µs to 10s
Sampling period		50µs to 3,600s	200µs to 3,600s
Maximum display/PLC		6½ digits	5½ digits
Data memory		10,000	10,000

\*PLC : Power Line Cycle

## Variable Integration Time

The integration time can be set from 10µs to 10s for the 7461A and from 100µs to 10s for the 7451A, which allows you to easily measure the average current of cellular phones or LCDs. The newly developed A/D converter of which integration time can be set to any values is based on the analog integration technique, so that it provides precise average measurement data, differently from the digital method using a discrete sampling.

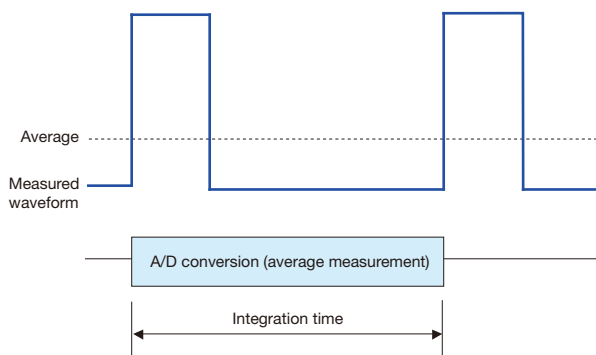

## Full Array of Trigger Functions

Various types of measurements are supported by the built-in trigger functions such as the level trigger and the delta trigger.

Maximum sampling rate: 200 readings/sec (from 5ms)

### Level Trigger Measurement

Change in signal → Measurement start  
Measurement starts when **LEVEL** exceeds the threshold value.

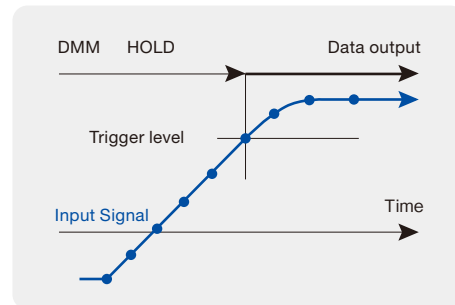

### Delta Trigger Measurement

Signal convergence → Measurement start  
Measurement starts when the **change width** exceeds the threshold value.

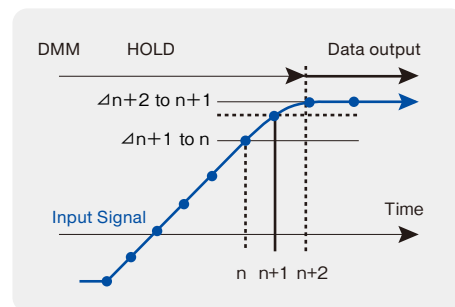

## Low Power Resistance Measurement

In resistance measurement, measurement current may cause heat generation in a measured device and variation in its measured values. Low-power 2WΩ/4WΩ resistance measurement uses only 1/10 of the typical measurement current, minimizing the effect of thermal fluctuation.

## Easy System Configuration by Two-channel DCV Measurement

With the DCV-Bch input (10V range fixed), current measurement and two-channel voltage measurement can be switched, which enhances the measurement throughput. (Rating voltage between Bch Hi and COM: 12V)

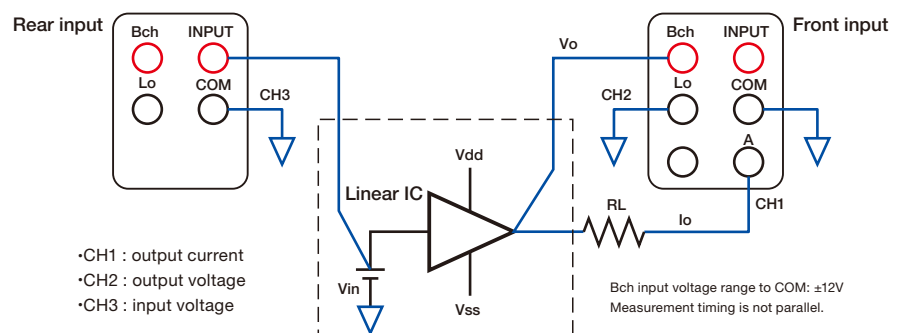

- CH1 : output current
- CH2 : output voltage
- CH3 : input voltage



## Standby Current Measurement of Cellular Phone

In a cellular phone, the peak current flows in the standby state at a constant period, and the base current flows in other states. This standby time varies depending on the adopted method. To measure the average current precisely, it is necessary to measure all current passing during the standby time.

The 7461A and the 7451A are capable of current waveform measurement including peak current measurement by fast sampling of 20,000 readings and 5,000 readings per second respectively. Also, these models are capable of accurate average current measurement by using the variable integration time function, in which the integration time can be set to any value up to 10 seconds.

Current waveform Measurement and Average Current Measurement

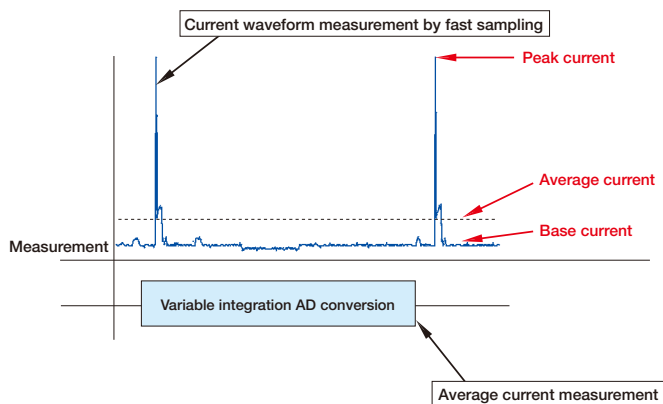

## Rising Signal Measurement by Delta Trigger and Pre-Trigger

The delta trigger starts measurement by detecting the slope of a signal. This function is convenient for starting measurement when data increases or is stabilized after convergence, and also supports various kinds of change patterns.

The pre-trigger is used to capture data before the trigger event. This function is convenient for analyzing signal states, for example, when an abnormal measurement value is detected.

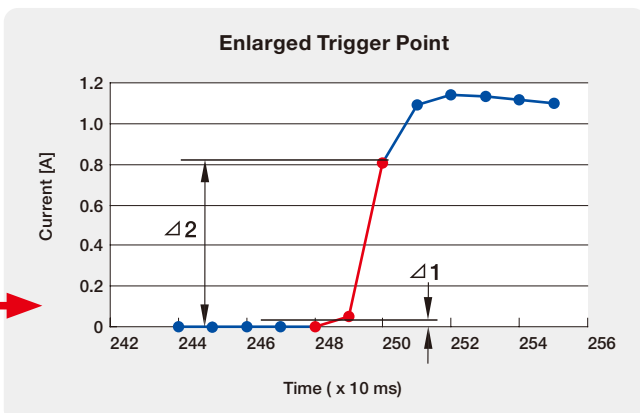
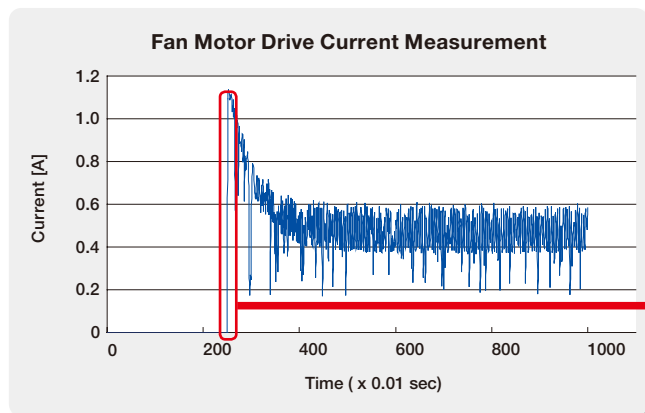

Delta trigger setting example

Measurement starts when the signal change exceeds +0.2A.

## Thermistor Low-Power Resistance Measurement

The 7461A/7451A is equipped with the low-power resistance measurement function as standard. This enables measurement of a thermistor or other heat sensitive elements with reduced effect from self-heating.

When a thermistor is measured in the  $1k\Omega$  range with the normal  $4W\Omega$  function, the measurement current is  $1mA$  and the resistance values will change significantly.

On the other hand, the  $LP4W\Omega$  function is used, the measurement current is  $100\mu A$  which is  $1/10$  the normal value  $4W\Omega$ , and there will be small change in resistance values.

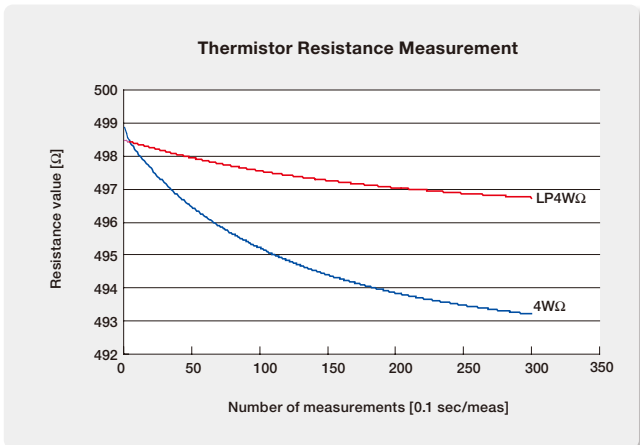

## Low-Noise Current Measurement (7461A)

The 7461A is stable in low current measurement and also highly sensitive with the minimum resolution of 1nA. Its performance is quite

useful for evaluation and inspection of portable devices and electronic components that require low current consumption.

### DCI 10mA-Range Measurement Variation Comparison in 1PLC

7461A

4 digits (40nA)

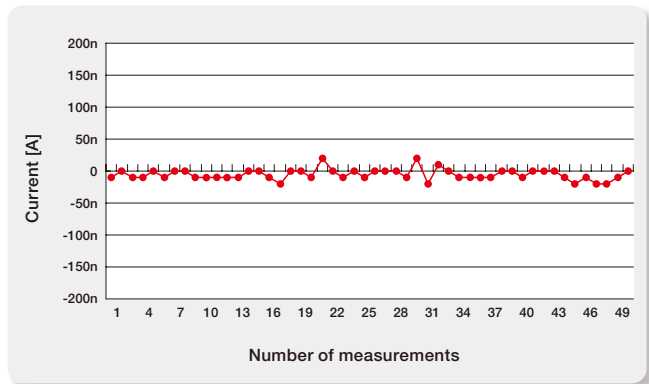

A Company 6½-digit DMM

26 digits (260nA)

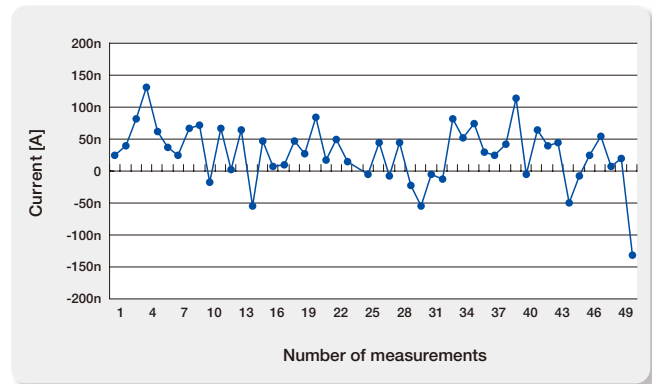

## USB Interface as Standard

This instrument is equipped with a USB interface in addition to a GPIB interface as standard, allowing easy measurement data transfer to a PC. The following shows an example of controlling the digital multimeter and capturing measurement data onto an Excel sheet in

graphical format by using sample software. In this way, automatic measurement is easily achieved by connecting through the USB interface.

Measurement example (Excel window)

7461A DIGITAL MULTIMETER		
1	DCV	+052. 1439E-03
2	DCV	+052. 1531E-03
3	DCV	+052. 1679E-03
4	DCV	+052. 1701E-03
5	DCV	+052. 1888E-03
6	DCV	+052. 1937E-03
7	DCV	+052. 2012E-03
8	DCV	+052. 1988E-03
9	DCV	+052. 1855E-03
10	DCV	+052. 1749E-03
11	DCV	+052. 1663E-03

Specified number of times

: Take data specified number of times

Attach to any sample sheet from the measurement sample software.

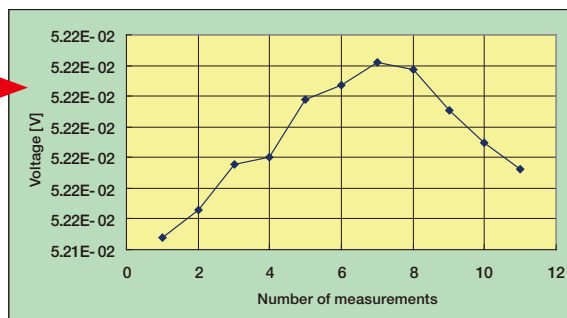

**Specifications** Unless otherwise specified, the measurement accuracy is guaranteed for one year under the following conditions: Temperature; 23±5°C, relative humidity; 85% or less (75% or less in resistance measurement of 20MΩ or more and low power resistance measurement of 2MΩ or more). Temperature coefficient: For the 4 ½-digit display, the digit error is reduced to 1/10.

## ■ DC Voltage Measurement (DCV)

### 7461A

Input terminal	Range	Maximum display	Resolution	Input impedance <sup>3</sup>	Measurement accuracy <sup>1</sup> ± (% of reading + digits)			Temperature coefficient ± (ppm of reading + digits)/°C	
					24 hours: 23°C±1°C <sup>2</sup>	90 days: 23°C±5°C	1 year: 23°C±5°C	Auto-zero ON	Auto-zero OFF
V-COM	100mV	119.9999	100nV	More than 1GΩ/10MΩ±1%	0.0030+30.0	0.0040+35.0	0.0040+35.0	5.0+5.0	5.0+7.0
	1000mV	1199.999	1μV	More than 1GΩ/10MΩ±1%	0.0020+4.0	0.0030+5.0	0.0040+5.0	5.0+1.0	5.0+5.0
	10V	11.99999	10μV	More than 1GΩ/10MΩ±1%	0.0020+3.0	0.0030+3.0	0.0035+3.0	5.0+1.0	5.0+5.0
	100V	119.9999	100μV	10MΩ±1%	0.0020+5.0	0.0035+5.0	0.0045+5.0	5.0+1.0	5.0+5.0
	1000V	1099.999	1mV	10MΩ±1%	0.0020+5.0	0.0035+5.0	0.0040+5.0	5.0+1.0	5.0+5.0
BchHi-COM	10V	11.99999	10μV	More than 1GΩ	0.0020+3.0	0.0030+3.0	0.0035+3.0	5.0+1.0	5.0+5.0

<sup>1</sup> Integration time: 10 PLC, Display digit: 6½, Auto-zero: ON

<sup>2</sup> Relative to the calibration accuracy

<sup>3</sup> In the 100mV, 1000mV, and 10V ranges, the input impedance can be selected from either 10MΩ or more than 1GΩ

### 7451A

Input terminal	Range	Maximum display	Resolution	Input impedance <sup>3</sup>	Measurement accuracy <sup>1</sup> ± (% of reading + digits)			Temperature coefficient ± (ppm of reading + digits)/°C	
					24 hours: 23°C±1°C <sup>2</sup>	90 days: 23°C±5°C	1 year: 23°C±5°C	Auto-zero ON	Auto-zero OFF
V-COM	300mV	319.999	1μV	More than 1GΩ/10MΩ±1%	0.0020+5.0	0.0060+7.0	0.0140+7.0	8.0+1.0	8.0+5.0
	3000mV	3199.99	10μV	More than 1GΩ/10MΩ±1%	0.0020+2.0	0.0060+3.0	0.0100+3.0	7.0+0.1	7.0+3.0
	30V	31.9999	100μV	10MΩ±1%	0.0020+3.0	0.0070+6.0	0.0150+6.0	8.0+1.0	8.0+3.0
	300V	319.999	1mV	10MΩ±1%	0.0020+2.0	0.0060+3.0	0.0140+3.0	8.0+0.1	8.0+3.0
	1000V	1099.99	10mV	10MΩ±1%	0.0020+2.0	0.0060+3.0	0.0140+3.0	8.0+0.1	8.0+1.2
BchHi-COM	10V	11.9999	100μV	More than 1GΩ	0.0020+2.0	0.0100+3.0	0.0100+3.0	8.0+0.1	8.0+1.0

<sup>1</sup> Integration time: 10 PLC, Display digit: 6½, Auto-zero: ON

<sup>2</sup> Relative to the calibration accuracy

<sup>3</sup> In the 300mV and 3000mV ranges, the input impedance can be selected from either 10MΩ or more than 1GΩ

### 7461A/7451A

Additional error depending on the integration time

Integration time	Additional error ± (digits + μV)		
	7461A	7451A	
10μs ≤ IT ≤ 200μs	—	3½ digits: 2+20	
100μs ≤ IT ≤ 200μs	—	3½ digits: 2+20	
200μs < IT ≤ 2ms	Includes FAST1 and FAST2	4½ digits: 2+20	
2 ms < IT < 1 PLC	—	5½ digits: 2+20	
2.01ms ≤ IT ≤ 9.99ms	—	5½ digits: 20+20	
10 ms ≤ IT < 1 PLC	—	5½ digits: 2+20	
1PLC ≤ IT < 10PLC	Integral multiple of 1PLC	6½ digits: 1+0	
10PLC < IT ≤ 10s	Integral multiple of 1PLC	6½ digits: 2+0	

Maximum input

Between V and COM	1000 Vpeak
Between BchHi and COM	200 Vpeak

Noise rejection ratio

Integration time	Effective CMRR <sup>4</sup>		
	DC	50/60Hz ±0.08%	NMRR
Integral multiple of 1PLC	130dB	120dB	60dB
Others	130dB	60dB	0dB

<sup>4</sup> Unbalanced impedance of 1kΩ

## ■ AC Voltage Measurement (ACV, ACV (AC+DC))

### 7461A

Measurement method: True RMS measurement, RMS display

Input range: 5% or more of a full scale

Crest factor: 5 : 1 at a full scale

Temperature coefficient: (1/10 of measurement accuracy that includes the additional error)/°C in each range and frequency range)

ACV

Input terminal	Range	Maximum display	Resolution	Input impedance	Measurement accuracy <sup>1</sup> ± (% of reading + digits) 23°C±5°C					
					20Hz-45Hz	45Hz-100Hz	100Hz-20kHz	20kHz-50kHz	50kHz-100kHz	100kHz-300kHz <sup>2</sup>
V-COM	100mV	119.9999	100nV	1MΩ±2%, 140pF or less	0.28+600	0.1+600	0.06+600	0.12+1800	0.6+2100	5+6000
	1000mV	1199.999	1μV	1MΩ±2%, 140pF or less	0.28+500	0.1+500	0.06+500	0.12+500	0.6+800	4+5000
	10V	11.99999	10μV	1MΩ±2%, 140pF or less	0.28+400	0.1+400	0.06+400	0.12+500	0.6+800	4+5000
	100V	119.9999	100μV	1MΩ±2%, 140pF or less	0.28+400	0.1+400	0.06+400	0.12+500	0.6+800	4+5000
	700V	749.999	1mV	1MΩ±2%, 140pF or less	0.28+280	0.1+280	0.06+280	0.12+350	0.6+580	4+3500

<sup>1</sup> AC filter: SLOW, Integration time: 10PLC, Display digit: 6½, Sine-wave input. The input voltage is restricted to 2.2 × 10<sup>3</sup> V Hz in the 100V and 700V ranges.

If the input voltage is 10% or less of the full scale, 30μV is added to the measurement accuracy as the additional error.

<sup>2</sup> 100kHz-200kHz in the 100mV and 1000mV range.

ACV (AC+DC)

Input terminal	Range	Maximum display	Resolution	Input impedance	Measurement accuracy <sup>1</sup> ± (% of reading + digits) 23°C±5°C					
					20Hz-45Hz	45Hz-100Hz	100Hz-20kHz	20kHz-50kHz	50kHz-100kHz	100kHz-300kHz <sup>2</sup>
V-COM	100mV	119.99	10μV	1MΩ±12%, 140pF or less	0.28+6	0.1+6	0.06+6	0.12+18	0.6+21	5+60
	1000mV	1199.9	100μV	1MΩ±12%, 140pF or less	0.28+5	0.1+5	0.06+5	0.12+5	0.6+8	4+50
	10V	11.999	1mV	1MΩ±12%, 140pF or less	0.28+4	0.1+4	0.06+4	0.12+5	0.6+8	4+50
	100V	119.99	10mV	1MΩ±12%, 140pF or less	0.28+4	0.1+4	0.06+4	0.12+5	0.6+8	4+50
	700V	749.9	100μV	1MΩ±12%, 140pF or less	0.28+3	0.1+3	0.06+3	0.12+4	0.6+6	4+35

<sup>1</sup> AC filter: SLOW, Integration time: 10PLC, Display digit: 4½, Sine-wave input. The input voltage is restricted to 2.2 × 10<sup>3</sup> V Hz in the 100V and 700V ranges.

If the input voltage is 10% or less of the full scale, 30μV is added to the measurement accuracy as the additional error.

<sup>2</sup> 100kHz-200kHz in the 100mV and 1000mV range.

## 7451A

Measurement method: True RMS measurement, RMS display

Input range: 5% or more of a full scale

Crest factor: 3 : 1 at a full scale

Temperature coefficient: (1/10 of measurement accuracy that includes the additional error)/ °C in each range and frequency range)

ACV

Input terminal	Range	Maximum display	Resolution	Input impedance	Measurement accuracy <sup>1</sup> ± (% of reading + digits)					
					20Hz–45Hz	45Hz–100Hz	100Hz–20kHz	20kHz–50kHz	50kHz–100kHz	100kHz–300kHz <sup>2</sup>
V–COM	300mV	319.999	1μV	1MΩ±2%, 140pF or less	0.28+120	0.1+120	0.06+120	0.2+150	0.6+240	5+1500
	3000mV	3199.99	10μV	1MΩ±2%, 140pF or less	0.28+120	0.1+120	0.06+120	0.2+150	0.6+240	4+1500
	30V	31.9999	100μV	1MΩ±2%, 140pF or less	0.28+120	0.1+120	0.06+120	0.2+150	0.6+240	4+1500
	300V	319.999	1mV	1MΩ±2%, 140pF or less	0.28+120	0.1+120	0.06+120	0.2+150	0.6+240	4+1500
	700V	749.99	10mV	1MΩ±2%, 140pF or less	0.28+28	0.1+28	0.06+28	–	–	–

<sup>1</sup> AC filter: SLOW, Integration time: 10PLC, Display digit: 5%, Sine-wave input. The input voltage is restricted to 2.2 × 10<sup>3</sup> V Hz in the 300V and 700V ranges.

<sup>2</sup> 100kHz–200kHz in the 300mV and 3000mV range.

ACV (AC+DC)

Input terminal	Range	Maximum display	Resolution	Input impedance	Measurement accuracy <sup>1</sup> ± (% of reading + digits)					
					20Hz–45Hz	45Hz–100Hz	100Hz–20kHz	20kHz–50kHz	50kHz–100kHz	100kHz–300kHz <sup>2</sup>
V–COM	300mV	319.99	10μV	1MΩ±12%, 140pF or less	0.28+12	0.1+12	0.06+12	0.2+15	0.6+24	4+150
	3000mV	3199.9	100μV	1MΩ±12%, 140pF or less	0.28+12	0.1+12	0.06+12	0.2+15	0.6+24	4+150
	30V	31.999	1mV	1MΩ±12%, 140pF or less	0.28+12	0.1+12	0.06+12	0.2+15	0.6+24	4+150
	300V	319.99	10mV	1MΩ±12%, 140pF or less	0.28+12	0.1+12	0.06+12	0.2+15	0.6+24	4+150
	700V	749.9	100mV	1MΩ±12%, 140pF or less	0.28+3	0.1+3	0.06+3	–	–	–

<sup>1</sup> AC filter: SLOW, Integration time: 10PLC, Display digit: 4%, Sine-wave input. The input voltage is restricted to 2.2 × 10<sup>3</sup> V Hz in the 300V and 700V ranges.

<sup>2</sup> 100kHz–200kHz in the 300mV and 3000mV range.

## 7461A/7451A

Additional error depending on the crest factor  
(For non-sine-wave input)

	7461A	7451A
1–2	0.05% of range	0.05% of range
2–3	0.15% of range	0.15% of range
3–5	0.4% of range	–

Additional error depending on the AC filter Integration time: 10PLC

Frequency bandwidth	Additional error (% of reading)				Response time <sup>1</sup>
	20Hz–45Hz	45Hz–100Hz	100Hz–1kHz	More than 1kHz	
SLOW 20Hz–300kHz	0	0	0	0	3s
MED 20Hz–300kHz	0.7	0.23	0.04	0	500ms
FAST 300Hz–300kHz	–	–	0.1	0	100ms

<sup>1</sup> Time until the measurement value reaches within 0.1% of the final value in the same range.

Additional error depending on the integration time AC filter: SLOW

Integration time	Additional error (±digits)	
	7461A	7451A
10μs ≤ IT < 200μs	–	3½ digits: 2
100μs ≤ IT < 200μs	–	3½ digits: 2
200μs ≤ IT ≤ 2ms	Includes FAST1 and FAST2	4½ digits: 4
2ms < IT < 1PLC	–	5½ digits: 20
2.01ms ≤ IT ≤ 9.99ms	–	5½ digits: 20
10ms ≤ IT < 1PLC	–	5½ digits: 12
1PLC ≤ IT < 10PLC	–	6½ digits: 120
10PLC < IT ≤ 10s	–	6½ digits: 2

Maximum input

Between V and COM	700Vrms, 1000Vpeak, 2.2 × 10 <sup>3</sup> VHz
-------------------	---

## ■ Resistance Measurement (2WΩ, LP-2WΩ, 4WΩ, LP-4WΩ)

### 7461A

2WΩ/4WΩ measurement

Range	Maximum display	Resolution	Measurement current	Measurement accuracy <sup>1</sup> ± (% of reading + digits)			Temperature coefficient <sup>4</sup> ± (ppm of reading + digits)/°C	
				24 hours: 23°C±1°C <sup>2</sup>	90 days: 23°C±5°C	1 year: 23°C±5°C	Auto-zero ON	Auto-zero OFF
100Ω	119.9999	100μΩ	10mA	0.0030+30.0	0.0060+35.0	0.0080+35.0	6.0+5.0	6.0+5.0
1000Ω	1199.999	1mΩ	1mA	0.0020+5.0	0.0060+5.0	0.0080+8.0	6.0+1.0	6.0+5.0
10kΩ	11.99999	10mΩ	100μA	0.0020+5.0	0.0060+5.0	0.0080+8.0	6.0+1.0	6.0+5.0
100kΩ	119.9999	100mΩ	10μA	0.0020+5.0	0.0060+5.0	0.0080+8.0	6.0+1.0	6.0+5.0
1000kΩ	1199.999	1Ω	5μA	0.0020+10.0	0.0060+30.0	0.0080+30.0	10.0+5.0	10.0+7.0
10MΩ	11.99999	10Ω	500nA	0.0150+10.0	0.0200+30.0	0.0300+30.0	30.0+5.0 <sup>3</sup>	30.0+7.0 <sup>3</sup>
100MΩ	119.9999	100Ω	50nA	0.3000+100.0	0.5000+100.0	0.6000+100.0	700.0+5.0	700.0+7.0

<sup>1</sup> Integration time: 10 PLC, Auto-zero: ON for 2WΩ, Display digit: 6½

The offset error, which consists of the input cable resistance and 0.2Ω, is added in 2WΩ measurement.

<sup>2</sup> Relative to the calibration standard

<sup>3</sup> 15ppm/°C is added in the temperature range of 30°C to 50°C.

<sup>4</sup> The temperature coefficient in Auto-zero ON is used in the 4WΩ measurement.

Low power 2WΩ/4WΩ measurement (LP-2WΩ/LP-4WΩ)

Range	Maximum display	Resolution	Measurement current	Measurement accuracy <sup>1</sup> ± (% of reading + digits)			Temperature coefficient <sup>4</sup> ± (ppm of reading + digits)/°C	
				24 hours: 23°C±1°C <sup>2</sup>	90 days: 23°C±5°C	1 year: 23°C±5°C	Auto-zero ON	Auto-zero OFF
100Ω	119.9999	100μΩ	1mA	0.0030+30.0	0.0070+50.0	0.0100+60.0	6.0+5.0	6.0+8.0
1000Ω	1199.999	1mΩ	100μA	0.0020+30.0	0.0070+50.0	0.0100+60.0	6.0+5.0	6.0+8.0
10kΩ	11.99999	10mΩ	10μA	0.0020+30.0	0.0070+50.0	0.0100+60.0	7.0+5.0	7.0+8.0
100kΩ	119.9999	100mΩ	5μA	0.0020+15.0	0.0070+50.0	0.0100+60.0	10.0+5.0	10.0+25.0
1000kΩ	1199.999	1Ω	500nA	0.0150+15.0	0.0450+50.0	0.0500+60.0	65.0+5.0 <sup>3</sup>	65.0+8.0 <sup>3</sup>
10MΩ	11.99999	10Ω	50nA	0.3000+100.0	0.6000+100.0	0.8000+100.0	700.0+5.0	700.0+8.0 <sup>3</sup>

<sup>1</sup> Integration time: 10 PLC, Auto-zero: ON for 2WΩ, Display digit: 6½

The offset error, which consists of the input cable resistance and 0.2Ω, is added in 2WΩ measurement.

<sup>2</sup> Relative to the calibration standard

<sup>3</sup> 15ppm/°C is added in the temperature range of 30°C to 50°C.

<sup>4</sup> The temperature coefficient in Auto-zero ON is used in the 4WΩ measurement.

Response time: 100MΩ=5s (Time until the measurement value reaches within 0.1% of the final value)

1MΩ/10MΩ=0.5s (Time until the measurement value reaches within 0.1% of the final value)

## 7451A

### 2WΩ/4WΩ measurement

Range	Maximum display	Resolution	Measurement current	Measurement accuracy <sup>*1</sup> ± (% of reading + digits)			Temperature coefficient <sup>*5</sup> ± (ppm of reading + digits)/°C	
				24 hours: 23°C±1°C <sup>*2</sup>	90 days: 23°C±5°C	1 year: 23°C±5°C	Auto-zero ON	Auto-zero OFF
30Ω	31.9999	100μΩ	10mA	0.0030+30.0	0.0100+40.0	0.0150+40.0	10.0+5.0	10.0+50.0
300Ω	319.999	1mΩ	1mA	0.0020+5.0	0.0080+11.0	0.0150+11.0	10.0+1.0	10.0+6.0
3000Ω	3199.99	10mΩ	1mA	0.0020+3.0	0.0070+3.0	0.0120+3.0	10.0+0.2	10.0+3.0
30kΩ	31.9999	100mΩ	100μA	0.0020+3.0	0.0070+3.0	0.0130+3.0	10.0+0.2	10.0+3.0
300kΩ	319.999	1Ω	10μA	0.0020+3.0	0.0090+3.0	0.0140+3.0	8.0+0.2	8.0+3.0
3000kΩ	3199.99	10Ω	1μA	0.0070+14.0	0.0300+19.0	0.0300+19.0	35.0+5.0	35.0+5.0
30MΩ	31.9999	100Ω	100nA	0.0600+14.0	0.1800+19.0	0.2000+19.0	100.0+5.0 <sup>*3</sup>	100.0+5.0 <sup>*3</sup>
300MΩ	319.999	1kΩ	10nA	0.6000+14.0	1.7000+19.0	2.0000+19.0	1000.0+5.0 <sup>*4</sup>	1000.0+5.0 <sup>*4</sup>

\*1 Integration time: 10 PLC, Auto-zero: ON for 2WΩ, Display digit: 5½

The offset error, which consists of the input cable resistance and 0.2Ω, is added in 2WΩ measurement.

\*2 Relative to the calibration standard

\*3 115ppm/°C is added in the temperature range of 30°C to 50°C.

\*4 1150ppm/°C is added in the temperature range of 30°C to 50°C.

\*5 The temperature coefficient in Auto-zero ON is used in the 4WΩ measurement.

### Low power 2WΩ/4WΩ measurement (LP-2WΩ/LP-4WΩ)

Range	Maximum display	Resolution	Measurement current	Measurement accuracy <sup>*1</sup> ± (% of reading + digits)			Temperature coefficient <sup>*5</sup> ± (ppm of reading + digits)/°C	
				24 hours: 23°C±1°C <sup>*2</sup>	90 days: 23°C±5°C	1 year: 23°C±5°C	Auto-zero ON	Auto-zero OFF
300Ω	319.999	1mΩ	100μA	0.0030+30.0	0.0080+40.0	0.0150+40.0	10.0+5.0	10.0+50.0
3000Ω	3199.99	10mΩ	100μA	0.0020+5.0	0.0080+11.0	0.0150+11.0	10.0+1.0	10.0+5.0
30kΩ	31.9999	100mΩ	10μA	0.0020+5.0	0.0080+11.0	0.0150+11.0	10.0+1.0	10.0+5.0
300kΩ	319.999	1Ω	1μA	0.0070+5.0	0.0300+11.0	0.0300+11.0	30.0+1.0	30.0+5.0
3000kΩ	3199.99	10Ω	100nA	0.0600+20.0	0.1800+33.0	0.2000+33.0	100.0+5.0 <sup>*3</sup>	100.0+5.0 <sup>*3</sup>
30MΩ	31.9999	100Ω	10nA	0.6000+20.0	1.7000+33.0	2.0000+33.0	1000.0+5.0 <sup>*4</sup>	1000.0+5.0 <sup>*4</sup>

\*1 Integration time: 10 PLC, Auto-zero: ON for 2WΩ, Display digit: 5½

The offset error, which consists of the input cable resistance and 0.2Ω, is added in 2WΩ measurement.

\*2 Relative to the calibration standard

\*3 115ppm/°C is added in the temperature range of 30°C to 50°C.

\*4 1150ppm/°C is added in the temperature range of 30°C to 50°C.

\*5 The temperature coefficient in Auto-zero ON is used in the 4WΩ measurement.

Response time: 300MΩ=5s (Time until the measurement value reaches within 0.1% of the final value)

3MΩ/30MΩ=0.5s (Time until the measurement value reaches within 0.1% of the final value)

## 7461A/7451A

Additional error depending on the integration time

Integration time		Additional error ± (digits + mΩ)	
		7461A	7451A
10μs ≤ IT ≤ 200μs	—	3½ digits: 2+20	—
100μs ≤ IT ≤ 200μs	—	—	3½ digits: 2+20
200μs < IT ≤ 2ms	Includes FAST1 and FAST2	4½ digits: 2+20	4½ digits: 10+20
2ms < IT < 1PLC	—	5½ digits: 2+20	—
2.01ms ≤ IT ≤ 9.99ms	—	—	5½ digits: 20+20
10ms ≤ IT < 1PLC	—	—	5½ digits: 2+20
1PLC ≤ IT < 10PLC	Integral multiple of 1PLC	6½ digits: 1+0	5½ digits: 1+0
10PLC < IT ≤ 10s	Integral multiple of 1PLC	6½ digits: 2+0	5½ digits: 2+0

Open-circuit voltage: 9.5V or less

Maximum input

Between Ω and COM	1000Vpeak
Between 4WΩHi and 4WΩLo	200Vpeak

## DC Current Measurement (DCI)

### 7461A

Input terminal	Range	Maximum display	Resolution	Resistance between input terminals	Measurement accuracy <sup>*1</sup> ± (% of reading + digits)			Temperature coefficient ± (ppm of reading + digits)/°C	
					24 hours: 23°C±1°C <sup>*2</sup>	90 days: 23°C±5°C	1 year: 23°C±5°C	Auto-zero ON	Auto-zero OFF
mA-COM	1000μA	1199.999	1nA	103Ω	0.005+15	0.0180+20.0	0.0200+20.0	30.0+5.0	30.0+6.0
	10mA	11.99999	10nA	10.5Ω	0.005+15	0.0250+20.0	0.0250+30.0	30.0+5.0	30.0+6.0
	100mA	119.9999	100nA	1.5Ω	0.008+15	0.0250+20.0	0.0250+30.0	35.0+5.0	35.0+6.0
	1000mA	1199.999	1μA	0.5Ω	0.03+15	0.0300+20.0	0.0500+30.0	50.0+10.0	50.0+10.0
	3A	3.19999	10μA	0.5Ω	0.1+15	0.1000+20.0	0.1000+30.0	50.0+20.0	50.0+30.0

\*1 Integration time: 10 PLC, Display digit: 6½, Auto-zero: ON

\*2 Relative to the calibration standard

### 7451A

Input terminal	Range	Maximum display	Resolution	Resistance between input terminals	Measurement accuracy <sup>*1</sup> ± (% of reading + digits)			Temperature coefficient ± (ppm of reading + digits)/°C	
					24 hours: 23°C±1°C <sup>*2</sup>	90 days: 23°C±5°C	1 year: 23°C±5°C	Auto-zero ON	Auto-zero OFF
mA-COM	3000μA	3199.99	10nA	10.5Ω	0.01+30	0.0300+40.0	0.0500+40.0	45.0+4.0	45.0+10.0
	30mA	31.9999	100nA	10.5Ω	0.01+4.5	0.0300+6.0	0.0500+6.0	45.0+0.6	45.0+7.0
	300mA	319.999	1μA	1.5Ω	0.03+4.5	0.0600+6.0	0.1000+6.0	50.0+0.6	50.0+7.0
	3000mA	3199.99	10μA	0.5Ω	0.12+4.5	0.1200+6.0	0.1200+6.0	50.0+0.6	50.0+7.0

\*1 Integration time: 10 PLC, Display digit: 5½, Auto-zero: ON

\*2 Relative to the calibration standard



## 7461A/7451A

Additional error depending on the integration time

Integration time		Additional error ( $\pm$ digits)	
		7461A	7451A
$10\mu\text{s} \leq \text{IT} \leq 200\mu\text{s}$	—	3½ digits: 2	—
$100\mu\text{s} \leq \text{IT} \leq 200\mu\text{s}$	—	—	3½ digits: 2
$200\mu\text{s} < \text{IT} \leq 2\text{ms}$	Includes FAST1 and FAST2	4½ digits: 2	4½ digits: 10
$2\text{ms} < \text{IT} < 1\text{PLC}$	—	5½ digits: 2	—
$2.01\text{ms} \leq \text{IT} \leq 9.99\text{ms}$	—	—	5½ digits: 20
$10\text{ms} \leq \text{IT} < 1\text{PLC}$	—	—	5½ digits: 2
$1\text{PLC} \leq \text{IT} < 10\text{PLC}$	Integral multiple of 1PLC	6½ digits: 1	5½ digits: 1
$10\text{PLC} < \text{IT} \leq 10\text{s}$	Integral multiple of 1PLC	6½ digits: 2	5½ digits: 2

Maximum allowable applied current

Between mA and COM : 3A (DC or ACrms)

Input protection : By using the 3.15A/250V fast blow fuse which is compliant with IEC127 sheet1  
The fuse can be changed on the rear panel.

## ■ AC Current Measurement (ACI, ACI (AC+DC))

### 7461A

Measurement method: True RMS measurement, RMS display

Input range: 5% or more of a full scale

Crest factor: 5 : 1 at a full scale (except for the 3A range)

Temperature coefficient: (1/10 of measurement accuracy that includes the additional error)/ °C in each range and frequency range)

ACI

Input terminal	Range	Maximum display	Resolution	Resistance between input terminals	Measurement accuracy <sup>1</sup> ± (% of reading + digits) 23°C±5°C		
					20Hz–45Hz	45Hz–100Hz	100Hz–5kHz
mA–COM	1000µA	1199.999	1nA	103Ω	0.45+400	0.25+400	0.11+400
	10mA	11.99999	10nA	10.5Ω	0.45+400	0.25+400	0.11+400
	100mA	119.9999	100nA	1.5Ω	0.45+400	0.25+400	0.11+400
	1000mA	1199.999	1µA	0.5Ω	0.45+400	0.25+400	0.11+400
	3A	3.19999	10µA	0.5Ω	0.45+120	0.25+120	0.15+120

<sup>1</sup> AC filter: SLOW, Integration time: 10PLC, Display digit: 6½, Sine-wave input

ACI (AC+DC)

Input terminal	Range	Maximum display	Resolution	Resistance between input terminals	Measurement accuracy <sup>1</sup> ± (% of reading + digits) 23°C±5°C		
					20Hz–45Hz	45Hz–100Hz	100Hz–5kHz
mA–COM	1000µA	1199.9	100nA	103Ω	0.45+4	0.25+4	0.11+4
	10mA	11.999	1µA	10.5Ω	0.45+4	0.25+4	0.11+4
	100mA	119.99	10µA	1.5Ω	0.45+4	0.25+4	0.11+4
	1000mA	1199.9	100µA	0.5Ω	0.45+4	0.25+4	0.11+4
	3A	3.199	1mA	0.5Ω	0.45+1.2	0.25+1.2	0.15+1.2

<sup>1</sup> AC filter: SLOW, Integration time: 10PLC, Display digit: 4½, Sine-wave input

Additional error depending on the crest factor (For non-sine-wave input)

1–2	0.05% of range
2–3	0.15% of range
3–5	0.4% of range

### 7451A

Measurement method: True RMS measurement, RMS display

Input range: 5% or more of a full scale

Crest factor: 3 : 1 at a full scale (except for the 3A range)

Temperature coefficient: (1/10 of measurement accuracy that includes the additional error)/ °C in each range and frequency range)

ACI

Input terminal	Range	Maximum display	Resolution	Resistance between input terminals	Measurement accuracy <sup>1</sup> ± (% of reading + digits) 23°C±5°C		
					20Hz–45Hz	45Hz–100Hz	100Hz–5kHz
mA–COM	3000µA	3199.99	10nA	10.5Ω	0.45+200	0.25+200	0.2+200
	30mA	31.9999	100nA	10.5Ω	0.45+200	0.25+200	0.2+200
	300mA	319.999	1µA	1.5Ω	0.45+200	0.25+200	0.2+200
	3000mA	3199.99	10µA	0.5Ω	0.45+200	0.25+200	0.2+200

<sup>1</sup> AC filter: SLOW, Integration time: 10PLC, Display digit: 5½, Sine-wave input

ACI (AC+DC)

Input terminal	Range	Maximum display	Resolution	Resistance between input terminals	Measurement accuracy <sup>1</sup> ± (% of reading + digits) 23°C±5°C		
					20Hz–45Hz	45Hz–100Hz	100Hz–5kHz
mA–COM	3000µA	3199.9	100nA	10.5Ω	0.45+20	0.25+20	0.2+20
	30mA	31.999	1µA	10.5Ω	0.45+20	0.25+20	0.2+20
	300mA	319.99	10µA	1.5Ω	0.45+20	0.25+20	0.2+20
	3000mA	3199.9	100µA	0.5Ω	0.45+20	0.25+20	0.2+20

<sup>1</sup> AC filter: SLOW, Integration time: 10PLC, Display digit: 4½, Sine-wave input

Additional error depending on the crest factor (For non-sine-wave input)

Range	Crest factor ± (% of reading + % of range)	
	1 to 2	2 to 3
3000µA	0+0.05	0+0.15
30mA	0.01+0.05	3+0.15
300mA	0+0.05	0.3+0.15
3000mA	0+0.05	0.03+0.15

## 7461A/7451A

Additional error depending on the AC filter Integration time: 10PLC

Frequency bandwidth	Additional error (% of reading)				Response time <sup>*1</sup>
	20Hz-5kHz	45Hz-100Hz	100Hz-1kHz	More than 1kHz	
SLOW	0	0	0	0	3s
MED	0.7	0.23	0.04	0	500ms
FAST	—	—	0.1	0	100ms

\*1 Time until the measurement value reaches within 0.1% of the final value in the same range.

Maximum allowable applied current

Between mA and COM : 3A (DC or ACrms)

Input protection: By using the 3.15A/250V fast blow fuse which is compliant with IEC127 sheet1

The fuse can be changed on the rear panel.

## ■ Frequency Measurement (FREQ)

### 7461A/7451A

Measurement method : Reciprocal

Measurement frequency range	Measurement accuracy (Sine-wave wave)
1Hz to 10Hz	0.05% of reading
10Hz to 300kHz	0.02% of reading

Gate time

Sampling rate	Gate time	Measurement frequency range	Maximum measurement period	Maximum display	
				7461A	7451A
SLOW	1000ms	1Hz-300kHz	2.2s	9999999	999999
MED	100ms	10Hz-300kHz	220ms	999999	99999
FAST	10ms	100Hz-300kHz	22ms	99999	9999

## ■ Diode Measurement

### 7461A/7451A

	Range	Maximum display	Resolution	Measurement current
7461A	1000mV	1199.999	1μV	1mA
7451A	3000mV	3199.99	10μV	1mA

The specifications other than the above are the same as those of 1000Ω range (7461A) or 3000Ω range (7451A) in 2WΩ measurement.

The offset error, which is calculated by the following formula; (the input cable resistance +0.2Ω) x 1mA, is added in 2WΩ measurement.

## ■ Measurement Speed

### 7461A/7451A

Sampling rate	Measurement speed (in Auto-range OFF)				Integration time	Auto-zero
	DCV Bch-DCV DCI 2WΩ LP-2WΩ	4WΩ LP-4WΩ	ACV ACI Continuity Diode	ACV (AC+DC) ACI (AC+DC)		
FAST1	1000 rdgs/s <sup>*1</sup>	110 rdgs/s	400 rdgs/s	4 rdgs/s	0.02PLC	OFF
FAST2	300 rdgs/s <sup>*1</sup>	80 rdgs/s	250 rdgs/s	4 rdgs/s	0.1PLC	OFF
MED	20 rdgs/s	20 rdgs/s	20 rdgs/s	3 rdgs/s	1PLC	ON
SLOW1	4.5 rdgs/s	4.5 rdgs/s	4.5 rdgs/s	2 rdgs/s	5PLC	ON
SLOW2	2 rdgs/s	2 rdgs/s	2 rdgs/s	1 rdgs/s	10PLC	ON

Conditions of high-speed sampling to data memory (No remote output)

	7461A	7451A
Highest speed	20,000 rdgs/s	5,000 rdgs/s
Target function	DCV, Bch-DCV, DCI, 2WΩ, LP-2WΩ	
Conditions	Integration time: 10μsec	Integration time: 100μsec
	Sampling interval: 50μsec	Sampling interval: 200μsec
Auto range : OFF <sup>*1</sup>		

(The measurement data memory stores up to 10,000 data.)

\*1 Under the following conditions:  
 Trigger source : BUS, EXT, MAN  
 Sampling count : 2 or more  
 Complete signal output mode : SINGLE  
 Display : OFF, Calculation : OFF, Measurement data memory : ON

## ■ Maximum input

### 7461A/7451A

Between V, Ω, Hz and COM	1000Vpeak
Between 4WΩ, Bch Hi and Lo	200Vpeak
Between 4WΩ, Bch Hi/Lo and COM	200Vpeak
Between COM and chassis	500V
Between 4WΩ, Bch Hi and chassis	500V

Additional error depending on the integration time AC filter: SLOW

Integration time	Additional error (±digits)	
	7461A	7451A
10μs ≤ IT < 200μs	—	—
100μs ≤ IT < 200μs	—	3½ digits: 2
200μs ≤ IT ≤ 2ms	Includes FAST1 and FAST2	4½ digits: 4
2ms < IT < 1PLC	—	5½ digits: 20
2.01ms ≤ IT ≤ 9.99ms	—	—
10ms ≤ IT ≤ 1PLC	—	5½ digits: 20
1PLC ≤ IT < 10PLC	—	6½ digits: 120
10PLC < IT ≤ 10s	—	6½ digits: 2

Input signal voltage range 100mVrms to 700Vrms (The input signal is restricted to the maximum input.)

Maximum input

Between V and COM	700Vrms, 1000Vpeak, 2.2 × 10 <sup>-1</sup> V-Hz
-------------------	---

## ■ Continuity Measurement

### 7461A/7451A

	Range	Maximum display	Resolution	Measurement current
7461A	1000Ω	1199.999	1mΩ	1mA
7451A	3000Ω	3199.99	10mΩ	1mA

The specifications other than the above are the same as those of 1000Ω range (7461A) or 3000Ω range (7451A) in 2WΩ measurement.

Continuity judgment setting range: 1Ω to 1000Ω

Integration time (IT) and sampling interval (SI)

7461A		7451A	
Integration time (IT)		Integration time (IT)	
Setting range	Resolution	Setting range	Resolution
10μs to 199μs	1μs	100μs to 199μs	1μs
200μs to 9.99ms	10μs	200μs to 9.99ms	10μs
10ms to 5999.9ms	100μs	10ms to 5999.9ms	100μs
6s to 10s	200μs	6s to 10s	200μs
0.02PLC to 100PLC	0.01PLC	0.02PLC to 100PLC	0.01PLC
Sampling interval (SI)		Sampling interval (SI)	
Setting range		Setting range	
50μs to 3600s		200μs to 3600s	

Integration time and display digits

Function	DCV/DCI DCV-Bch 2W/4WΩ LP-2W/4WΩ ACV/ACI Diode and continuity		ACV (AC+DC) ACI (AC+DC)	
	7461A	7451A	7461A	7451A
Integration time (IT)				
10μs ≤ (IT) ≤ 200μs	3½ digits		3½ digits	
200μs < (IT) ≤ 2ms	4½ digits		3½ digits	
2ms < (IT) ≤ 15ms	5½ digits		4½ digits	
15ms < (IT) ≤ 10s	6½ digits	5½ digits	4½ digits	

## Calculation Functions

NULL calculation:

Display value (NULL) = Measurement value – NULL constant

Smoothing calculation:

Display value (SM) = Moving average over a specified number of measurements

Comparator calculation:

Display (HIGH) ← HIGH setting value < Measurement value

Display (LOW) ← Measurement value < LOW setting value

Display (GO) ← LOW setting value ≤ Measurement value ≤ HIGH setting value

Scaling calculation:

Display (SCL) = (Measurement value – B) / A × C

A, B and C are constants. (Setting value)

MAX and MIN calculation:

Display value (MAX) = Maximum measurement value after the calculation starts

Display value (MIN) = Minimum measurement value after the calculation starts

Display value (AVE) = Average value after the calculation starts

(Remote output only)

dB and dBm calculation: db display = 20 log (Measurement value / D)

dBm display = 10 log ((Measurement value)<sup>2</sup> / D) / 10<sup>-3</sup>

D is constant. (Setting value)

Statistical calculation:

Number of samples

Display value (SAMPLE) = Number of measurement values in the specified range of the measurement memory

Maximum value

Display value (MAX) = Maximum measurement value in the specified range of the measurement memory

Minimum value

Display value (MIN) = Minimum measurement value in the specified range of the measurement memory

Average value

Display value (AVE) = Average value in the specified range of the measurement memory

Standard deviation

Display value (SIGMA) = Standard deviation in the specified range of the measurement memory

Dispersion

Display value (P-P) = ((Maximum measurement value) – (Minimum measurement value)) in the specified range of the measurement memory

## Interface Specifications

### Remote control

Remote command: Compliance with SCPI and the command format for the R6552 and R64 series.

### Interface (GPIB or USB)

USB

Standard: Compliance with USB1.1

Connector: Type B

GPIB

Standard: Compliance with IEEE488.2-1987

Connector: 24-pin Amphenol

Interface function: SH1, AH1, T5, L4, SR1, RL1, PP0, DC1, DT1, C0, E2

Output format: ASC II

Addressing: 31 kinds of talker/listener addresses can be specified from the front panel.

### Comparator output

Output signal: TTL output: PASS/FAIL

Relay output: PASS/Hi/Lo

(PASS/FAIL output can be set individually.)

Connector: D-sub 9 pin

#### a. Photo MOS relay contact

Allowable contact voltage (for break) DC 30V

Allowable contact current DC 120mA

Contact-GND withstand voltage 30V

Contact operating time Approx. 1ms or less

#### b. TTL output

Output level TTL, selecting the positive or negative logic

Maximum input 12Vpeak

### External trigger signal

Connector: BNC

Signal level: TTL, detecting the falling edge

Pulse width: 1μs or more

### Complete signal output

Connector: BNC

Signal level: TTL, negative pulse

Sink current: 20mA or below

Pulse width: Approx. 5μs or 100μs can be selected.

## General Specifications

Operating environment:

Ambient temperature: 0°C to 50°C

Relative humidity: 85% or less, no condensation  
75% or less in resistance measurement of larger than 10MΩ and low power resistance measurement of larger than 1MΩ

Storage environment:

Ambient temperature: -25°C to 70°C

Relative humidity: 85% or less, no condensation  
60 minutes or more

Warm-up time:

Display:

7 segments x 7 digits vacuum fluorescent display

Range switching:

Automatic and manual

Input:

Floating

Measurement method:

Integration method

Overload display:

OL

Input switching:

Front and rear (Can be switched manually and remotely)

Front: VΩ, Hi (4WΩ/Bch), Lo (4WΩ/Bch), mA, and COM terminals

Rear: VΩ, Hi (4WΩ/Bch), Lo (4WΩ/Bch), and COM terminals

Memory:

Date memory: Up to 10,000 data

Condition setting memory: 4 (USER0 to USER3)

Trigger function:

External trigger: External trigger signal,

Panel key

BUS (GPIB, USB)

Internal trigger: Level trigger

Delta trigger

Power supply:

AC power supply: 100V/120V/220V/240V

(User selectable)

Option Number	Standard	OPT.32	OPT.42	OPT.44
Power supply voltage	100V	120V	220V	240V

Specify the option when ordering.

Use a power cable and a fuse that are compliant with the safety standard when changing the power supply voltage.

Power supply frequency:

50Hz/60Hz

Power consumption:

20VA or below

Dimensions:

Approx. 212 (W) x 88 (H) x 340 (D) mm

Mass:

3.4kg or less

Safety:

IEC61010-1

EN61010-1

Measurement category II

EMC:

EN61326 class B

## Supplied Accessories

Name	Model	Quantity
Power cable	A01402	1
Input cable (red, black)	CC010001	1 each
Alligator clip adapter (red, black)	CC15001	1 each
Power fuse (for 100V/120V)	DFT-AAR25A-1	1 <sup>1</sup>
Power fuse (for 220V/240V)	DFT-AAR16A-1	
Overcurrent protection fuse	DFS-AN3R15A-1	1
Operation manual	J7451A/61A	1

\*1: Either one is included according to the specified option.

## Optional Accessories

Name	Model	Remarks
Input cable	CC010001	Standard accessory
	A01001	Shielded cable
	A01006	For 4WΩ measurement
Alligator clip adapter	CC015001	Standard accessory
JIS rack-mount set	A02263	
	A02264	Twins
EIA rack-mount set	A02463	
	A02464	Twins
Panel-mount set	A02039	
	A02040	Twins

● Please read through the operation manual carefully before using the products.

● All specifications are subject to change without notice.



---

**E-mail : [kcc@adcmt.com](mailto:kcc@adcmt.com) URL : <http://www.adcmt-e.com>**

**Head Office**

Shoei Bldg, 3-6-12, Kyobashi, Chuou-ku,  
Tokyo 104-0031, Japan  
Phone: +81-3-6272-4433 Fax: +81-3-6272-4437

**Higashimatsuyama Office (R&D Center)**

77-1, Miyako Namegawa-machi, Hiki-gun,  
Saitama 355-0812, Japan  
Phone: +81-493-56-4433 Fax: +81-493-57-1092