

Luminance Colorimeter

# ***BM-5AC***



**BM-5A series for next-generation!**

# BM-5AC is a high sensitivity luminance colorimeter combines high reliability, operability and high speed.

## Feature

### POINT.1 High speed measuring for ultra low luminance.

It can measure the luminance as ultra low as 0.005 cd/m<sup>2</sup> at about 2 second.  
Note: For measurement angle of 3 degree.

### POINT.2 Wide measurement area

Selectable 5 measurement angle 0.1° / 0.2° / 1° / 2° / 3° enable you to measure the luminance from small to wide area without attachment lens.

### POINT.3 Analog output

The BM-5AC can connect to the recorder and the oscilloscope through analog output X<sub>2</sub>, Y, Z (selectable).

### POINT.4 USB Interface

The BM-5AC is equipped with USB and RS-232C interface.

## Response speed of analog output

Connecting to Oscilloscope through analog output, The BM-5AC can measure build up time and fall down time of flicker light.

Example) Rise and fall response characteristics, frequency, etc. of a flashing light source.

	NORMAL	FAST
Range 1	30ms	5ms
Range 2	30ms	0.5ms
Range 3	30ms	0.05ms
Range 4	30ms	0.5ms
Range 5	30ms	0.05ms



The response speed means the time that it takes analog output from the instrument to reach 90% of the peak value, when measuring an LED driven by a square wave from a function generator.

•Output impedance is approximately 100Ω.

Recording instrument must have Input impedance of 10kΩ or above.

•Output voltage 0 - 4.0V

\*The response speed in the table above is the time that it takes analog output from the instrument to reach 90% of the peak value, when measuring an LED driven by a square wave from a function generator.

## Usage

For measurement of luminance, chromaticity and color temperature, for example; optical characteristic test, Interior panel for automobile, Speed meter for automobile, Fluorescent substance.



FPD



Mobile phone



Car navigation

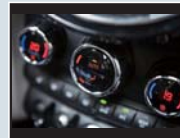

Automotive Switch

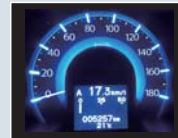

Speed meter



Fluorescent substance

### •Block diagram

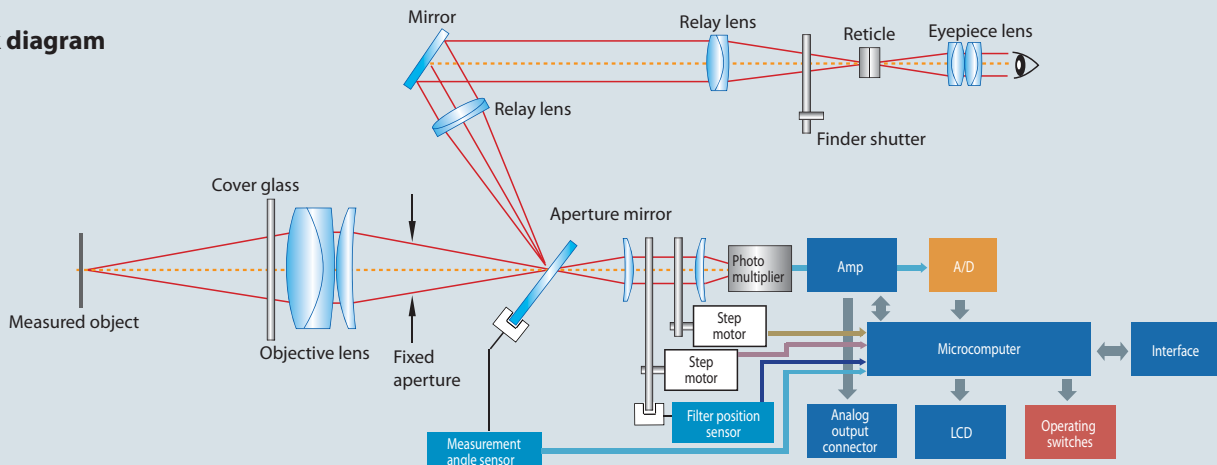

# Standard accessories software supports control of instrument and data collection

## BM-5AC colorimetry software CS-900A (standard accessory)

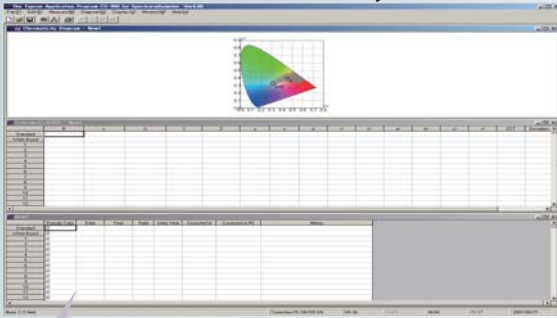

Application software CS-900A for Windows supports BM-5AC. You can control BM-5AC using by the CS-900A, and collect, save, plot on a graph and calculate of the measured data and, use them for many purpose.

On the Colorimetry mode, it can shorten the communication time between the instrument and PC due to omitting spectral data transmission.

- xy chromaticity graph
- Colorimetry data
- Measurement conditions / note

### •Chromaticity graph

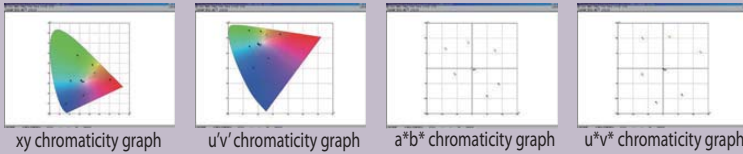

**Color space mode:** L, xy, XYZ, u'v', u\*a\*v\*, L\*a\*b\*, Correlated color temperature, Deviation, Dominant wavelength, Chromaticity Statistics

**Mode selection:**  
**AUTO EACH :**  
 The measuring device determines optimum measuring range for each filter automatically.  
**AUTO ALL :**  
 The measuring device determines measuring range automatically based on highest value among X<sub>0</sub>, Y<sub>0</sub>, Z<sub>0</sub>.  
**MANUAL ALL :**  
 Use this mode to set common measurement range for among X<sub>0</sub>, Y<sub>0</sub>, Z<sub>0</sub> manually.  
**MANUAL EACH :**  
 Use this mode to set individual measurement range to each X<sub>0</sub>, Y<sub>0</sub>, Z<sub>0</sub> filter manually.

**Selects the measurement mode:** Single / Interval / Continue

**Color Range Setting**  
 The software determines whether or not the measured color data fall within the specified range in the color diagram.

### System required (recommended)

- OS : Windows® 7 Ultimate / Professional (32bit / 64bit)  
Windows® 8.1 Pro or more (32bit/64bit)  
Windows® 10 Pro or more (32bit/64bit)
  - CPU : Intel® Core™ i3 2.4GHz or more
  - HDD : 1GB or more
  - Memory : 1GB or more
  - Ports : USB2.0 (One port) / RS-232C serial port (One port)
- \*The RS-232C cable (straight cable for DOS/V PC) must be purchased separately.

### •System diagram

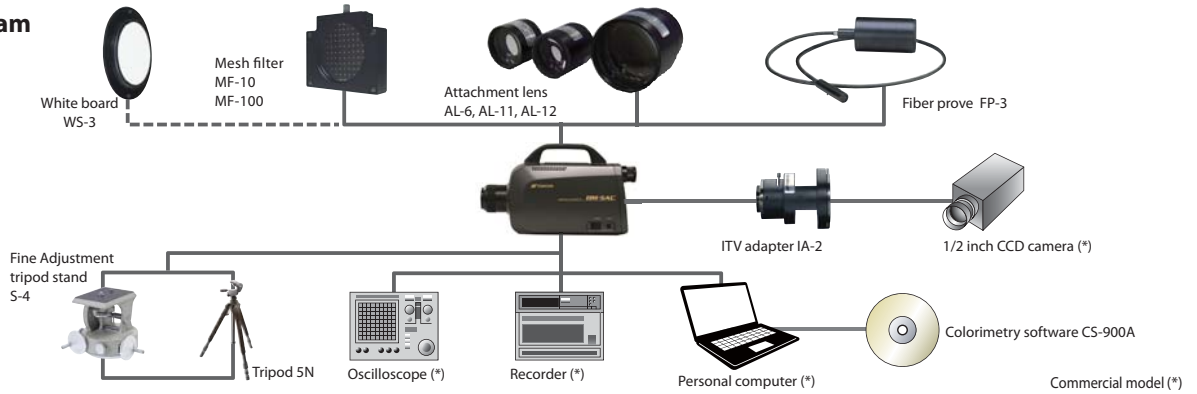

### •Name of the parts

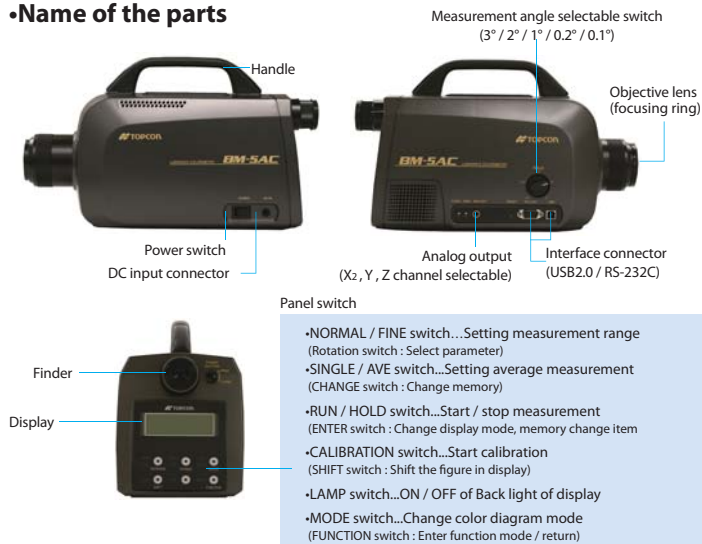

\*The switches in parentheses are enabled while in function mode.

### •External dimension

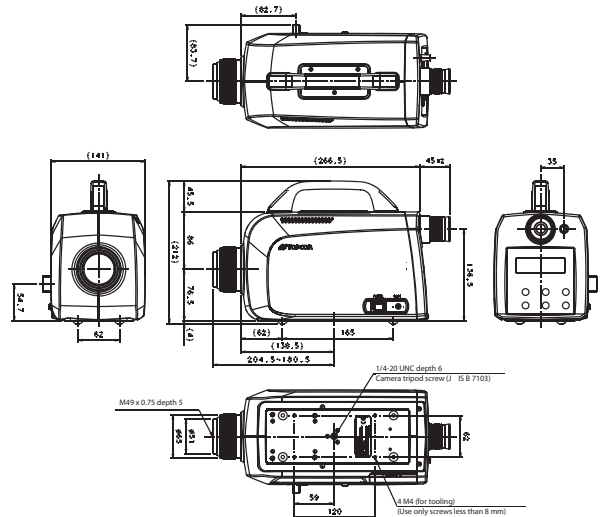

Units: mm

•Specification

Optical system	Objective lens : f=80mm F2.5 / Eyepiece lens : View field 5°, Diopter adjustment range ±5 diopter					
Spectral sensitivity	Similar to CIE1931 color matching function					
Photo detector	Photomultiplier tube					
Measurement angle	3° / 2° / 1° / 0.2° / 0.1° (Selectable)					
Measurement distance	350mm to ∞					
Measurement area Diameter (mm)	Measurement distance (mm)					
	Measurement angle	350	500	1,000	5,000	10,000
	3°	15.0	23.1	49.2	255	510
	2°	10.0	15.4	32.8	169	341
	1°	5.0	7.7	16.4	85	170
	0.2°	1.0	1.5	3.3	17	34
Measurable range	0.00005 to 1,200,000 cd/m <sup>2</sup>					
	Measurement angle	Luminance (cd/m <sup>2</sup> )				
	3°	0.005 to 1,500cd/m <sup>2</sup>				
	2°	0.01 to 3,000cd/m <sup>2</sup>				
	1°	0.04 to 12,000cd/m <sup>2</sup>				
Luminance range for guaranteed accuracy	0.2°	1 to 300,000cd/m <sup>2</sup>				
	0.1°	4 to 1,200,000cd/m <sup>2</sup>				
	Accuracy					
Repeatability *	• Luminance : ±4% (for standard source A)					
	• Chromaticity1 : dx,dy Within ±0.005 (Auto range, for standard source A)					
	• Chromaticity2 : dx,dy Within ±0.008 (O-55,Y-48,A-73B,IRA-05,T-44,R-61,B-46,V-44,G-54)					
	For a combination of the standard source A and the next colored glass, when COLOR ADJUSTMENT is applied.					
	• Luminance :					
Measurement range	Auto / Manual 5 steps selectable					
	Function					
	Luminance, CIE1931 chromaticity coordinates, CIE1976 chromaticity coordinates, Tristimulus value XYZ, Correlated color temperature and Deviation, CIE1976 L*a*b*, Eab*±Δ, CIE1976 L*u*v*, Euv*±Δ					
	Output					
	Analog output (X <sub>s</sub> , Y, Z), DC : 0 to 4V (One channel changeover type)					
	Digital output (Interface : USB / RS-232C)					
	Measurement time					
	About 2 seconds (Single measurement mode)					
	Display					
	Dot matrix 20 characters x 4 lines with back light					
Interface						
USB / RS-232C						
Power supply						
Dedicated AC adapter						
Power consumption						
Approximately 20 VA when using an AC adapter						
Operating condition						
Temperature : 0 to 40°C, Humidity : 85% R.H. or less (no condensation)						
Storage condition						
Temperature : -20 to 60°C, Humidity : 85% R.H. or less (no condensation)						
External dimensions						
Approx 355mm x 154mm x 212mm (LxWxD)						
Weight						
Approx 3.6Kg (main unit only)						

\*The precision value (luminance and chromaticity) written in this catalog is the specification value by our standard light source and measurement condition.  
 \*Due to the nature of the product, measurement error that is out of specification value may occur by the difference of the light source, measurement condition and measurement environment.

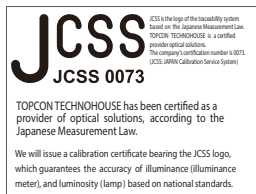

\* Some screens are simulated.  
 \* The specifications and external appearances of product in this catalogue may be changed without prior notice due to improvements.  
 \* The catalogue includes products that are sold separately.  
 \* The actual color of products may differ slightly from the catalogue due to lighting and printing conditions.

**TOPCON TECHNOHOUSE CORPORATION**

75-1 Hasunuma-cho, Itabashi-ku, Tokyo 174-8580 JAPAN  
 Phone: +81-3-3558-2666 Fax: +81-3-3558-4661  
 E-mail: techno-info@topcon.co.jp

**SAFETY PRECAUTIONS**

Make sure to carefully read the "Manual" to ensure that you use the product properly and safely.  
 • Always connect the instrument to the specified power supply voltage. Improper connection may cause a fire or electric shock.

For more information please visit our website.

<https://www.topcon-techno.co.jp/en/>



•Extra-cost option



•Attachment lens AL-6 / AL-11 / AL-12

Placing the attachment lens on the instrument's objective lens, the focal distance shorten and reduce the minimum measurement area.

(Specifications for Measuring Small Objects)

Measurement diameter (mm)	Measurement angle	AL-6 Measurement distance : 43 to 57mm	AL-11 Measurement distance : 19.8 to 24.2mm	AL-12 Measurement distance : 165 to 197mm
	3°	2.91 to 4.14	1.76 to 2.18	4.83 to 5.91
	2°	1.94 to 2.76	1.18 to 1.45	3.23 to 3.97
	1°	0.97 to 1.38	0.59 to 0.72	1.61 to 1.97
	0.2°	0.20 to 0.27	0.12 to 0.14	0.32 to 0.40
	0.1°	0.10 to 0.13	0.06 to 0.07	0.16 to 0.20

\*May change slightly according to the machining precision of the aperture mirror.  
 \*The measurement distance is the distance from the tip of the metal fixture on the instrument of the objective lens.



•White standard board WS-3

Uses when measuring object color and direction high directivity light.

- Luminance factor : 90% or less (Incidence 0°, Observation 45°)
- Material : Barium sulfate (BaSO<sub>4</sub>)
- Dimension : ø78mm, t=12.5mm
- Effective white surface : ø40mm (Central portion)



•Fiber probe FP-3

Light guide

- Effective measuring angle 2°
- Measurement diameter : ø3 to 10mm
- Measurement distance : 31.0 to 84.9mm
- Fiber length : about 1m



•ITV adapter IA-2

Adapter for connecting CCD camera (C mount, 1/2 inch) to the instrument.



•Mesh Filter MF-10 / MF-100

Uses when measuring the light which is over measurement range of the instrument.



•Tripod 5N

The tripod 5N make collimation easy.

- Max height : 1835mm
- Min height : 585mm
- Length when stored : 810mm
- Leg stages : 3steps
- Weight : 4.7kg with tripod head



•Fine adjustment tripod head S-4

The S-4 makes up / down / left / right collimation easy.

- Elevation angle : 40°
- Depression angle : 80°
- Rotation : 360°
- Weight : 1.7Kg

•Standard package of BM-5AC

- BM-5AC main body.....1ea.
- AC adapter .....1ea.
- Analog output plug.....3ea.
- CD-ROM (colorimetry software CS-900A / Instruction manual).....1ea.
- Quick manual.....1ea.
- Carrying case.....1ea.
- USB cable.....1ea.
- Lens cap for objective lens.....1ea.