



# WF1981 / WF1982 / WF1983 / WF1984 MULTIFUNCTION GENERATOR

## WAVE FACTORY



**30 MHz  
Model  
Available**

|                   |                |                       |   |
|-------------------|----------------|-----------------------|---|
| <b>0 ~ 30 MHz</b> | <b>21 Vp-p</b> | <b>Low jitter</b>     | <b>Large-capacity<br/>arbitrary waveforms</b> |
| <b>0 ~ 60 MHz</b> | <b>16 bit</b>  | <b>Low distortion</b> | <b>Parameter-variable<br/>waveforms</b>       |

# NF Corporation

# Essential waveforms can be generated effortlessly

To improve the "quality" and "efficiency" of testing"

..... As a signal source for testing across a wide range of fields .....

- 0 to 30 MHz / 0 to 60 MHz  
Resolution 0.01 μHz
- 1-channel / 2-channels
- 16-bit, 21 Vp-p / open **POINT!**
- Low distortion and low jitter
- Floating between input and output, isolated between channels (2-channel model)
- Sub-output – Independent from the main output **POINT!**
- 26 types of parameter-variable waveforms **POINT!**
- Pulse edge variable function **POINT!**
- High-speed and large-capacity arbitrary waveforms  
240 M samples/sec., 64 Mi words/waveform(WF1983/WF1984)
- 2-channel mode (WF1982/WF1984)
- Syncrator function **POINT!**

### Power semiconductor

For evaluating switching characteristics

#### Double pulse test

Parameter-variable waveform "Double pulse waveform"

On/off time can be freely set while outputting two pulse signals.

Variable parameters :

Rise time, Fall time,  
Lower bottom time, Upper bottom time

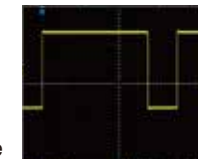

### Automotive

For verification of encoders, ECUs, etc.

Simulation of signal inputs for various ECUs

Noise superimposition testing on signal lines and power supplies

- Generate various analog and digital signals freely
- Multi-channel: sub-outputs and multiple units can be connected.
- Sequence function, large-capacity arbitrary waveforms
- Combined with bipolar power supply, high-voltage/large-current testing is possible.

### Piezoelectric elements

For evaluation tests involving actual operation

#### Haptics research

In research involving generation of vibration using piezoelectric elements, parameters such as amplitude, frequency, rise/fall times, can be controlled with high resolution, enabling accurate reproduction of subtle tactile sensations.

#### Application of ultrasound

Combined with a bipolar power supply, the unit applies high voltage/large current to devices, achieving stable operation and enabling dynamic performance evaluation.



| Model                | WF1981                   | WF1982 | WF1983               | WF1984 |
|----------------------|--------------------------|--------|----------------------|--------|
| Number of channels   | 1                        | 2      | 1                    | 2      |
| Frequency range      | 0 to 30 MHz              |        | 0 to 60 MHz          |        |
| Output voltage       | 0 Vp-p to 21 Vp-p / open |        |                      |        |
| Amplitude resolution | 16 bit                   |        |                      |        |
| Arbitrary waveform   | 32 Mi words/waveform     |        | 64 Mi words/waveform |        |



# The performance and features necessary to achieve the expected signal output

The stability in frequency and amplitude, noise performance, oscillation modes, and other capabilities required to faithfully generate desired waveforms

## 60 MHz / 30 MHz, High Accuracy and High Resolution

All models maintain a frequency accuracy of  $\pm(1 \text{ ppm of setting} + 4 \text{ pHz})$  and feature a frequency setting resolution of  $0.01 \text{ }\mu\text{Hz}$ , ensuring high resolution across a wide frequency range.

### Tips!

Setting the frequency to 0 during output allows users to maintain the output voltage at the current phase. For example, users can fix the output at a desired voltage level using a low-frequency signal.

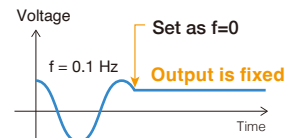

## Output Voltage 21 Vp-p / open

The maximum output voltage is 21 Vp-p / open and a DC offset voltage is  $\pm 10.5 \text{ V}$ . It can also be set to 0Vp-p. Even if the output is divided due to low load impedance, appropriate voltage can be expected at the load terminal.

### Tips!

Users can set the DC offset voltage and gradually increase the amplitude of the superimposed wave from 0 Vp-p. For example, intentionally superimposing noise as part of the device's signal source.

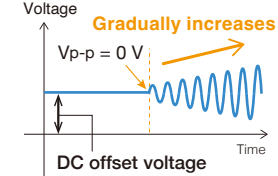

## Auto-ranging (20 V / 4 V / 0.8 V)

The auto-ranging function automatically selects the optimal output voltage range across the entire output voltage range. This reduces the decrease in amplitude setting accuracy due to the set level. Additionally, if discontinuity in amplitude due to range switching is a concern, selecting range hold is also possible.

## Amplitude Resolution 16 bits

The device maintains high resolution over a wide output voltage range and outputs waveforms with high reproducibility. The setting resolution is  $0.1 \text{ mVp-p}$  (for amplitudes  $< 3 \text{ V}$ ), ensuring stable output of low-amplitude signals.

## Low Distortion <0.03%

We have achieved a total harmonic distortion (THD) of 0.03% or less (10 Hz to 20 kHz, 2 Vp-p/50  $\Omega$ ). Significant improvements have been made in harmonic spurs, achieving -60 dBc typical (2 Vp-p/50  $\Omega$ ).

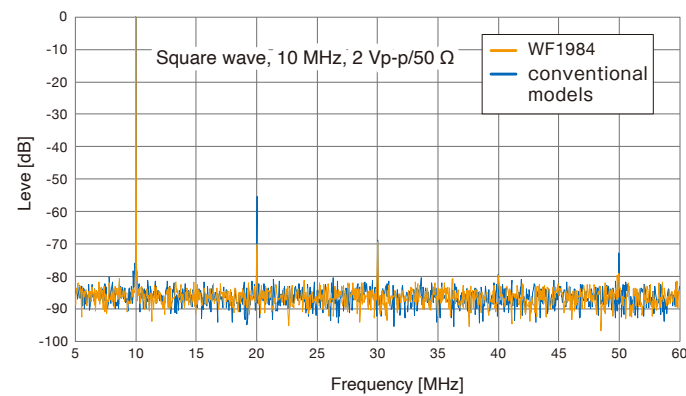

## Low Jitter <40 ps rms

Jitter has been significantly reduced compared to conventional models, enabling stable square wave output. Trigger jitter has also been reduced to below 300 ps rms (typ.).

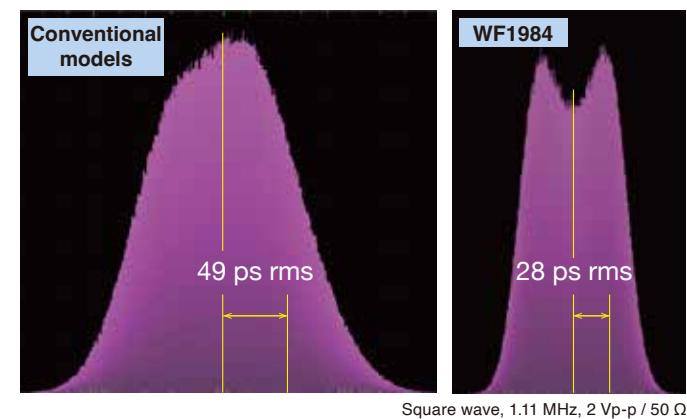

## Fast Rise/Fall Time 7.7ns

We have achieved high-speed rise and fall times in pulse waves. Compared to conventional models, we have significantly improved the reproducibility of square waves.

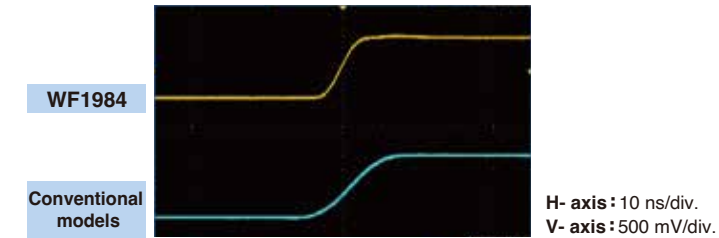

## Low Noise

We have significantly reduced the noise level compared to conventional models.

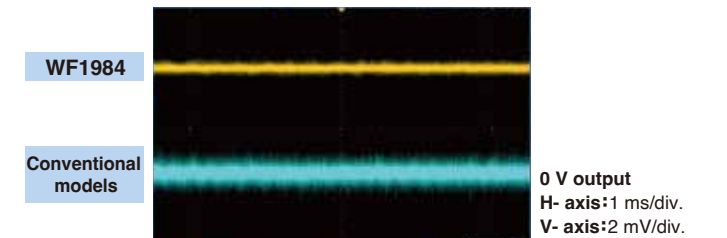

## Wide Range of Output Waveforms

We offer sine waves, square waves (with variable duty cycle), pulse waves (variable pulse width, duty cycle, rise/fall times), ramp waves (variable symmetry), Gaussian noise, DC, and 26 other waveforms commonly used in various fields as "Parameter-variable waveforms."

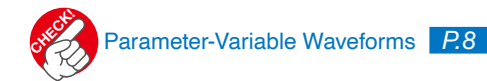

## High-speed and Large-capacity arbitrary waveforms 240 MS/sec, 64 Mi words

The WF1983 and WF1984 offer arbitrary waveform sampling rates of 240 M samples/sec. with a maximum of 64 Mi\* words per waveform. The WF1981 and WF1982 provide 120 M samples/sec. and a maximum of 32 Mi\* words per waveform. All four models are equipped with large capacity memory totaling approximately 4 Gi\* words. Arbitrary waveforms can also be saved to an external USB memory. Waveform creation can be performed using the unit or PC application software.

\* Mi = 2<sup>20</sup> = 1,048,576, Gi = 2<sup>30</sup> = 1,073,741,824

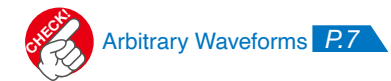

## Variety of Oscillation Modes

We offer a variety of oscillation modes, including continuous, sweep (frequency, phase, amplitude, DC offset, duty), burst (auto burst, triggered burst, gate, triggered gate), sequence, internal modulation / external modulation (FM, FSK, PM, PSK, AM, DC offset modulation, PWM). Each mode supports diverse settings, facilitating the efficient output of various test signals and streamlining complex testing processes.

## Sequence Function Max. of 1023 steps

We have incorporated a sequence function that allows for output while sequentially changing waveform, frequency, amplitude, DC offset, phase, and duty cycle. This can be programmed using either the unit or PC application software. The maximum number of steps has increased fourfold compared to conventional models, accommodating even lengthy and complex output patterns.



## Sweep

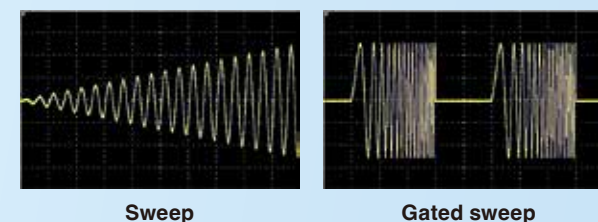

## Modulation

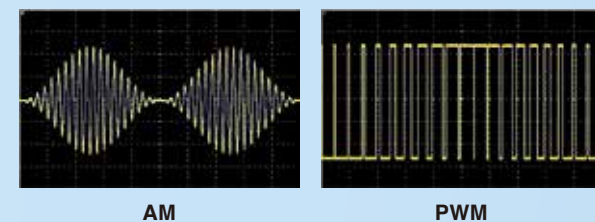

## Burst / Trigger / Gate

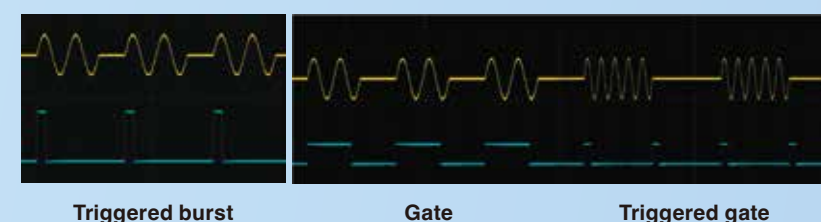

## Combining oscillation modes

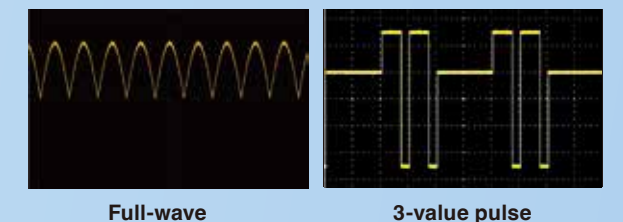

# The performance and features necessary to achieve the expected signal output

## As a Pulse Generator

The fast rise time and low jitter make these devices ideal as a signal source for testing digital circuits and electronic devices. In addition to independent settings for duty/pulse width, rise and fall times, the pulse wave has a pulse edge variable function, is available allowing versatile editing of pulse transition sections through this function.



## External Addition Input

Users can add signals from an external source to internally generated waveforms and output them. Phase difference can also be set as desired. The input frequency ranges from DC to 10 MHz.



### Tips!

In the 2-channel model, it is possible to add waveforms from CH1 and CH2. By connecting CH1's output to CH2's additive input, the waveforms from both channels are combined. This allows for easy implementation of harmonic addition and noise superposition.

## Upper and Lower Limiting Function

By setting upper and lower limits on the configuration values, it prevents excessive output due to operational errors. This is particularly effective for tests involving outputting high voltage or large current when connected to power amplifiers.

- Applicable settings: frequency, positive and negative peak values of output voltage, phase and duty

## Real-time Frequency Response Correction

Suppresses amplitude fluctuations in oscillation frequency and frequency sweeps.

## Burst + Modulation / Sweep + Modulation

It is possible to perform internal modulation/external modulation simultaneously with burst oscillation. External modulation can be used during sweep oscillation.

# Multi-Channel

Multiple channels can be configured when multiple signals are required for testing

## Sub-Output Function

The sub-output function can generate independent continuous signals from the main output. It allows setting waveform, phase, amplitude, DC offset, and phase difference with respect to the main output. When using internal modulation function on the main output, modulation waveforms can be output from the sub-output. It offers flexible settings that defy typical expectations of a sub-output. The 1-channel models are designed to function as 2-channel (2CH) models.

### Tips!

Waveforms of the main output and sub-outputs can be added and output using DC offset modulation. Various synchronization outputs such as reference phase synchronization output and burst synchronization output are also possible for the sub-output.

### Main Output and Sub-Output

|             | Max. voltage | Frequency*                 | Phase | Waveforms   | Oscillation modes  | Terminals    |
|-------------|--------------|----------------------------|-------|---|--|--------------|
| Main output | ±21 V        | 0 to 60 MHz<br>0 to 30 MHz | ±180° | Sine wave, Square wave, Pulse wave, Ramp wave, Parameter-variable waveform, Noise, DC, Arbitrary waveform   | Continuous, Sweep, Burst, Internal modulations, External modulations | FCTN OUT     |
| Sub-output  | ±3.3 V       | 0 to 5 MHz                 | ±180° | Sine wave, Square wave (50% duty), Triangle wave (50% symmetry), Rising / Falling ramp wave, Parameter-variable waveform, Noise, Arbitrary waveform | Continuously only  | SYNC/SUB OUT |

\* Continuous, sine wave

### Example of application

- Using the main output and sub-output to verify a comparator circuit.
- Inputting sine wave and triangle wave at different frequencies.
- Observing the output of the comparator.

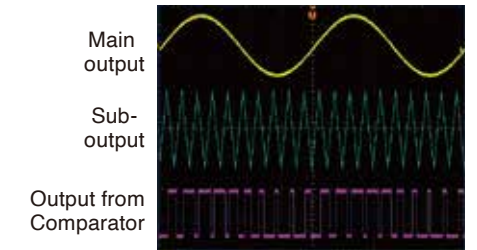
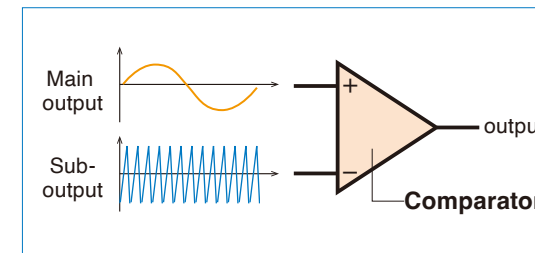

### Tips!

In the 2-channel model, by connecting in series, users can achieve a maximum of 42 Vp-p open-circuit sine wave output.

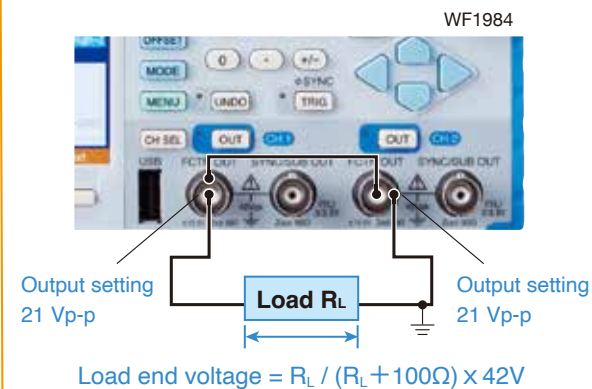

\* The upper frequency limit is around 100 kHz; do not connect anything to SYNC/SUB OUT.

## 2-Channel Mode (WF1982/WF1984)

In addition to independent settings for each channel, settings such as 2-phase and constant frequency difference can be made, and various sweeps can be performed with the 2-channel mode. Each output channel is isolated from the case, and each is also equipped with an external modulation/addition input and an external triggered input to ensure the independence of each channel.

- Independent
- 2-phase (same frequency)
- Constant frequency difference
- Constant frequency ratio
- Differential output (inverted phase waveform with same frequency, amplitude, and DC offset)
- Differential output 2 (inverted phase waveform with same frequency and amplitude, with opposite polarity DC offset)

## Multi-Unit Synchronization

It is possible to synchronize up to 6 units (12 channels maximum for 2-channel models) simultaneously. By utilizing the sub-output function, configurations can extend to accommodate up to 24 output channels.

### Example (3 units)

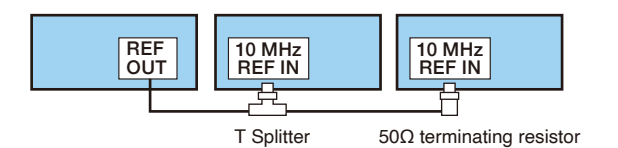

## As a Pulse Generator

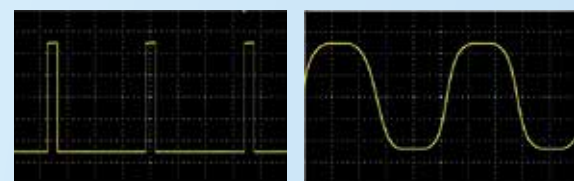

Pulse width variable Rising/Falling time variable

## External Addition

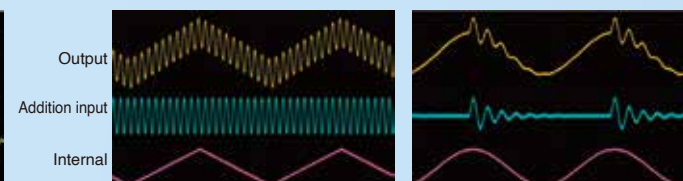

DC offset Surge wave

## Burst + Modulation, Sweep + Modulation



DC offset modulation (Rising ramp waveform) Amplitude modulation (Rising ramp waveform) Frequency sweep with amplitude modulation

## 2-Channel Mode

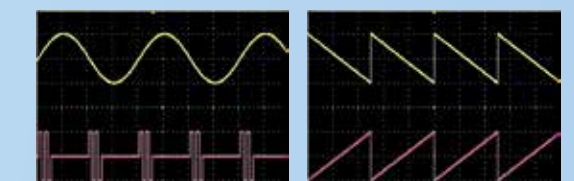

Independent Differential output



# Create complex waveforms with ease

Whether it's modifying pulse waves and sine waves, generating specialized waveforms for specific fields, or designing custom user-original waveforms, our products provide robust support for waveform creation.

## Pulse Edge Variable Function

The rising/falling transition portion (pulse edge) of the pulse waveform can be edited. In addition to general straight lines, cosine, parameter variable, and arbitrary waveforms can be set. For example, pulse waves can be freely processed by adding overshooting or ringing. It is also possible to change the waveform in real time while outputting without interrupting the test.

### Available edges

**Cosine**

- Rise: the 180° to 360° portion of the cosine waveform
- Fall: the invert of the rise waveform

**Straight line**

- Straight line for both the rise and the fall

**Parameter-variable waveform**

- Rise: the selected parameter-variable waveform
- Fall: the invert of the rise waveform

**Arbitrary waveform**

- Rise: the first half of the arbitrary waveform
- Fall: the latter half of the arbitrary waveform

Using the built-in second-order low-pass filter (LPF) waveform as a parameter-variable waveform, users can create a square wave with overshoot and ringing.

## Arbitrary Waveforms

### Long memory/High-speed sampling

Featuring a large-capacity waveform memory of up to 64Mi words per waveform and a total capacity of approximately 4Gi words, this model significantly surpasses conventional products. This expanded memory allows for the output of more complex waveforms. Additionally, the previously fixed sampling rate is now variable, enabling the output of longer waveforms by using slower sampling rates.

### Tips!

The large-capacity waveform memory is ideal for reproducing waveforms recorded with a data logger. By matching the sampling rate at the time of recording, waveforms can be reproduced without calculating the period or frequency.

- Can be created using the unit or control software.
- Waveform data can also be saved to an external USB memory.
- Parameters can be adjusted and saved as arbitrary waveforms for reuse.

## Sequence Function

Outputs can be made while successively changing waveform, frequency, phase, DC offset, and square wave duty. With flexible control of abrupt changes, sweeps, repetitions, and jumps, signals with long and complex output patterns that change from moment to moment, such as mechanical vibration and voltage fluctuations, can be easily programmed.

- Maximum number of steps 1023, Maximum number of usable waveforms 1023
- Can be created using the unit or separately provided control software.
- Sequence data can also be saved to USB memory.
- Sequence data created for conventional models (WF1973/WF1974/WF1967/WF1968) can also be used.

Pulse edge variable function

Arbitrary waveforms

Sequence function

Parameter-variable waveforms

## Parameter-variable waveforms

The unit includes 26 types of waveforms, commonly used as simulation signals in fields such as power, circuits, and machinery, pre-built that would typically need to be created as custom waveforms. Unique parameters for these waveforms can be set using the panel controls on the unit. Additionally, you can modify multiple unique parameters while outputting the waveform. Custom waveforms can also be saved, edited, and reused as needed.

### Tips!

The waveforms included as parameter-variable waveforms typically need to be created as custom waveforms if users want to modify parameters other than frequency and amplitude. However, with parameter-variable waveforms, users can easily adjust waveform-specific parameters using numerical input or modification knobs.

### Example of damped oscillation waveform

Frequency: 10 Hz Time constant: 10 %

Frequency: 4 Hz Time constant: 10 %

Frequency: 10 Hz Time constant: 20 %

### Variable parameters

- Oscillation frequency
- Damping time constant

Parameters can be changed with the modify knob!

## 26 types of parameter-variable waveforms

### Steady-state sine waves

|   |                                 |                                      |  |                                     |   |
|---|---------------------------------|--------------------------------------|--|-------------------------------------|---|
| Unbalanced sine<br>● 1st half amplitude<br>● 2nd half amplitude | Clipped sine<br>● Clipped ratio | CF controlled sine<br>● Crest factor | Conduction angle controlled sine<br>● Conduction angle | Staircase sine<br>● Number of steps | Multi-cycle sine<br>● Number of cycles<br>● Start phase |
|---|---------------------------------|--------------------------------------|--|-------------------------------------|---|

### Transient sine waves

|  |  |   |  |
|--|--|---|--|
| On-phase controlled sine<br>● Complete-on phase<br>● On-slope time | Off-phase controlled sine<br>● Off phase<br>● Off-slope time | Chattering-on sine<br>● On phase<br>● Number of chattering<br>● On-state time | Chattering-off sine<br>● Off phase<br>● Number of chattering<br>● Off-state time |
|--|--|---|--|

### Pulse waveforms

|  |  |                      |                            |  |  |
|--|--|----------------------|----------------------------|--|--|
| Gaussian pulse<br>● Standard deviation | Lorentz pulse<br>● Half value of width | Haversine<br>● Width | Half-sine pulse<br>● Width | Trapezoid pulse<br>● Slope width<br>● Upper base width | Sin(x)/x<br>● Number of zero crossings |
|--|--|----------------------|----------------------------|--|--|

### Transient response waveforms

|                                     |                                     |   |  |
|-------------------------------------|-------------------------------------|---|--|
| Exponential rise<br>● Time constant | Exponential fall<br>● Time constant | 2nd-order LPF step response<br>● LPF natural frequency<br>● LPF Q | Damped oscillation<br>● Oscillation frequency<br>● Damping time constant |
|-------------------------------------|-------------------------------------|---|--|

### Surge waveforms

|   |   |
|---|---|
| Oscillation surge<br>● Oscillation frequency<br>● Damping time constant<br>● Trailing time constant | Pulse surge<br>● Rising time<br>● Duration time |
|---|---|

### Other waveforms

|   |   |   |                                      |
|---|---|---|--------------------------------------|
| Trapezoid with offset<br>● Leading delay<br>● Rising-slope width<br>● Upper base width<br>● Falling-slope width<br>● Offset | NEW Double pulse<br>● Rising time<br>● Falling time<br>● Bottom base time 1/<br>Top base time 1<br>● Bottom base time 2/<br>Top base time 2 | Half sine edge pulse<br>● Leading edge time<br>● Trailing edge time<br>● Duty | Bottom referenced ramp<br>● Symmetry |
|---|---|---|--------------------------------------|

## Pulse Edge Variable

Top : Cosine  
Bottom : Straight line

Parameter-variable waveform  
Top : Exponential rise  
Bottom : Trapezoid wave with offset

## Example of Sequence waveforms

ISO 16750:2006 Automotive Electrical Equipment Test

Cardiac



# We offer a wealth of features along with excellent operability

## Syncrator Function

This feature automatically synchronizes the main output signal with an externally input signal. It is also possible to adjust the phase difference between the external input signal and the main output. This function is useful for applications involving waveform conversion or correction of fluctuating signals, as well as for rotational systems.

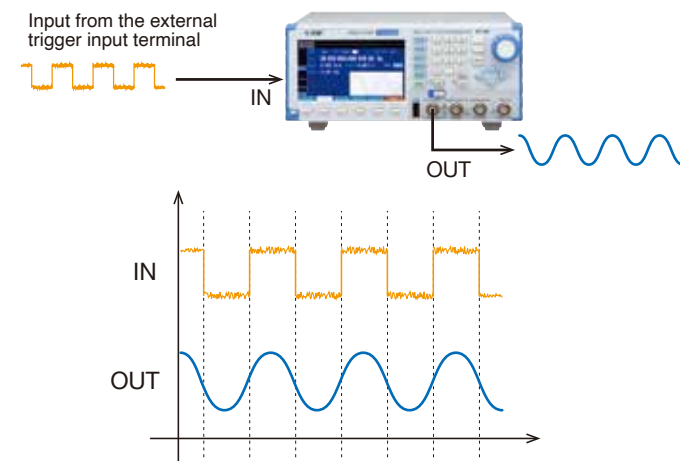

### Example of application

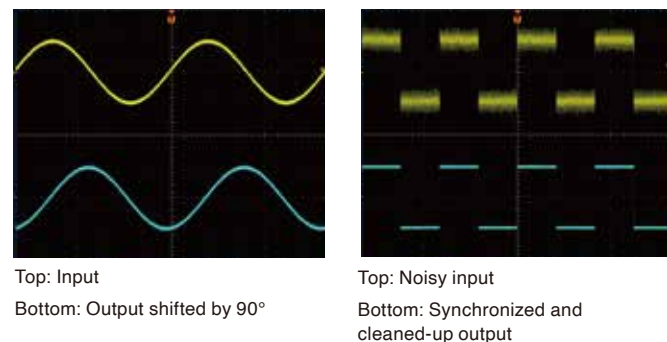

### Rich features that enhance usability and expand application range

- Equipped with a USB memory interface for reading and writing files
- **Setting Memory:** Stores up to 10 sets of settings.
- **User-Defined Units:** Enables setting in arbitrary units using specified conversion formulas (frequency, period, amplitude, DC offset, phase, duty).
- **Load Impedance:** Allows setting and displaying output voltage at specified load impedance.
- **External 10 MHz frequency reference input**
- **USB / LAN interfaces**
- **GPIB (WF1983 / WF1984)**
- **2U half-rack size, lightweight, approx. 1.8 kg**

## Noise Equivalent Bandwidth Setting

The noise waveform can be set to six different equivalent bandwidths: 30 MHz, 10 MHz, 3 MHz, 1 MHz, 300 kHz, and 100 kHz. Typically, when the bandwidth is limited using an external filter, the amplitude also decreases. However, it is possible to limit the noise bandwidth without needing an external filter while maintaining a constant amplitude (effective noise value).

Top: Conventional model (Bandwidth is fixed at 26 MHz)  
Middle: Conventional model 1 MHz LPF passed separately  
Bottom: WF1983 (Bandwidth : 1MHz)

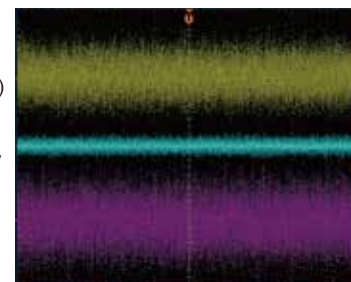

## The software that supports arbitrary waveform generation and sequence editing

### Control Software

This software allows output control via PC. It also supports arbitrary waveform generation and sequence editing.



### Arbitrary waveform creation



### Sequence editing



## Panel Component Names and Functions

### 2-channel models WF1982 / WF1984

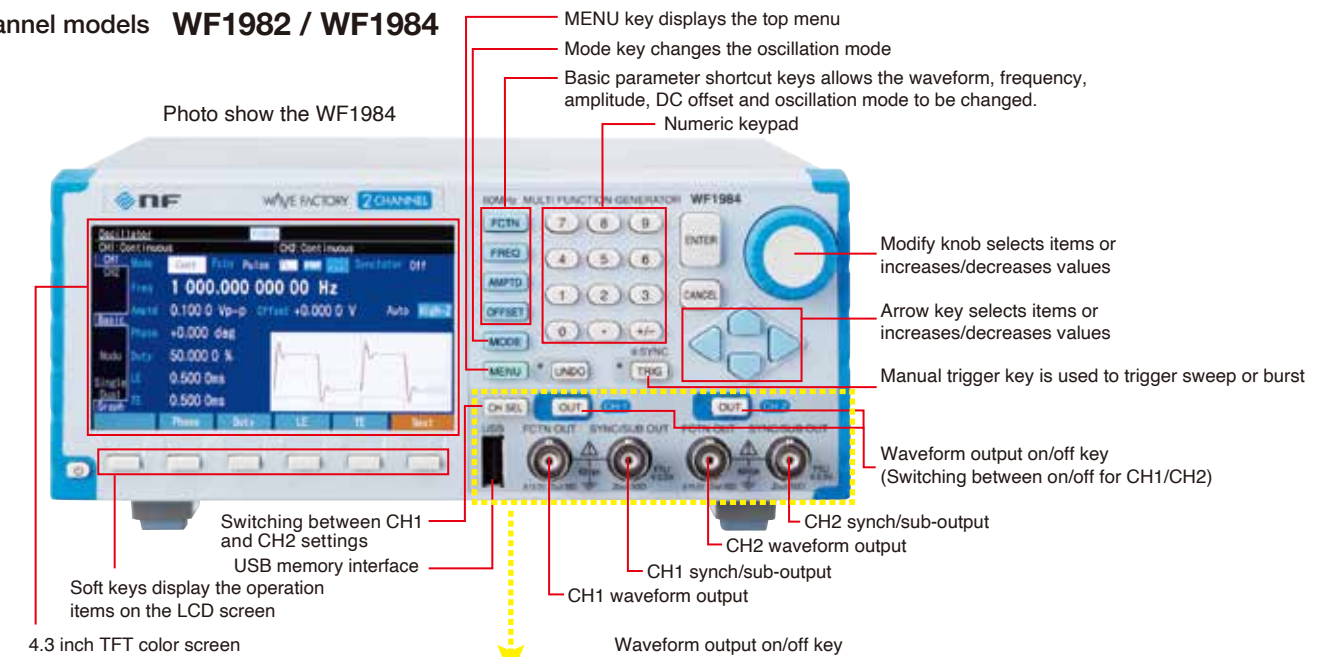

### 1-channel models: WF1981/WF1983

- Waveform output on/off key
  - External trigger input
  - External modulation/External addition input
  - Synch/Sub-output
  - Waveform output
- \* Each models are the same except for the input/output connectors on the front panel.

### Back panel

#### 2-channel model

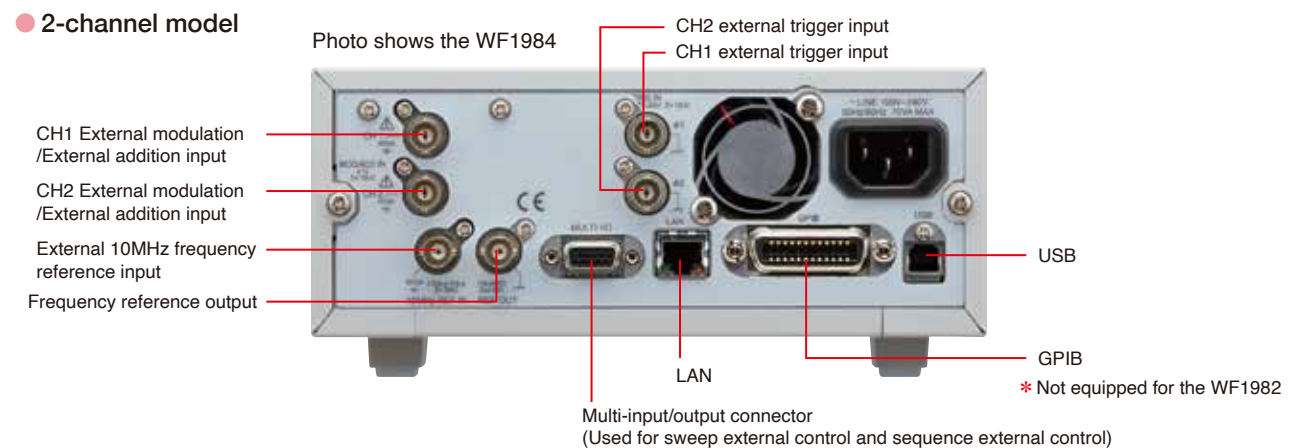

#### 1-channel model

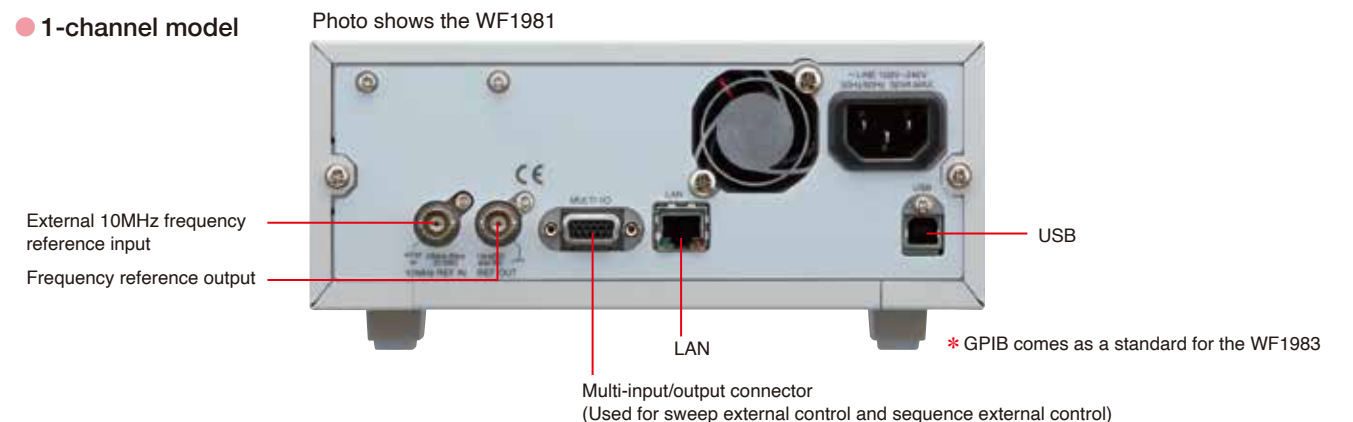

### Specifications

Unless otherwise specified, the conditions are as follows: waveform output (FCTN OUT) is the target, oscillation is continuous, load is 50 Ω, amplitude setting is 10 Vp-p/50 Ω, DC offset setting is 0 V, auto range for output voltage, amplitude range of waveform is ±FS, external addition is off, and AC voltage is effective value measurement.

#### Waveform, Oscillation Mode

|                  |   |
|------------------|---|
| Waveform         | Sine wave, square wave, pulse wave, ramp, parameter-variable wave, noise (gauss distribution), DC |
| Oscillation Mode | Continuous, modulation, sweep, burst, sequence  |

#### Frequency

| Model name                  | 30MHz  |                            |               | 60MHz   |                            |               |
|-----------------------------|--|----------------------------|---------------|---|----------------------------|---------------|
|                             | WF1981 (1ch) / WF1982 (2ch)  |                            |               | WF1983 (1ch) / WF1984 (2ch)   |                            |               |
| Oscillation Mode/Function   | Continuous, modulation, sweep(continuous, single)                            | Sweep(Gated single), burst | sequence      | Continuous, modulation, sweep(continuous, single)                                   | Sweep(Gated single), burst | sequence      |
| Sine wave                   | 0 to 30 MHz  | 0 to 10 MHz                | 0 to 10 MHz   | 0 to 60 MHz   | 0 to 20 MHz                | 0 to 20 MHz   |
| Square wave                 | 0 to 15 MHz  | 0 to 10 MHz                | 0 to 10 MHz   | 0 to 30 MHz   | 0 to 20 MHz                | 0 to 20 MHz   |
| Pulse wave                  | 0 to 15 MHz  | 0 to 10 MHz                | Not available | 0 to 30 MHz   | 0 to 20 MHz                | Not available |
| Ramp wave                   | 0 to 5 MHz   |                            | 0 to 5 MHz    | 0 to 10 MHz   |                            | 0 to 10 MHz   |
| Parameter-variable waveform | 0 to 5 MHz   |                            | 0 to 5 MHz*2  | 0 to 5 MHz  |                            | 0 to 5 MHz*2  |
| Noise                       | Equivalent bandwidth : select from 30 M / 10 M / 3 M / 1 M / 300 k / 100 kHz |                            |               | Equivalent bandwidth : select from FULL / 30 M / 10 M / 3 M / 1 M / 300 k / 100 kHz |                            |               |
| DC                          | Invalid frequency setting  |                            |               | Invalid frequency setting   |                            |               |
| Arbitrary waveform          | 0 to 5 MHz (Limited by number of samples and sampling rate)                  |                            |               | 0 to 15 MHz (Limited by number of samples and sampling rate)                        |                            |               |

|                                  |   |
|----------------------------------|---|
| Frequency setting resolution     | 0.01 μHz (<50 MHz)、0.1 μHz (50 MHz≤)*3  |
| Frequency setting with period    | Setting with frequency that is inverse number of set period less than 0.01 μHz is rounded off |
| Frequency accuracy at shipment*1 | ±(1 ppm of setting + 4 pHz)   |
| Frequency aging rate*1           | ±1 ppm/year   |

#### Phase

|                         |  |
|-------------------------|--|
| Waveform Output         | -1800.000° to +1800.000° (resolution 0.001°) |
| Sub-output/Sub-waveform | -180.000° to +180.000° (resolution 0.001°)   |

#### Output Characteristics

##### Amplitude

|                                  |   |
|----------------------------------|---|
| Setting range                    | 0 Vp-p to 21 Vp-p/open, 0 Vp-p to 10.5 Vp-p/50 Ω<br>A peak value combining waveform amplitude and DC offset is limited to ±10.5 V/open or less. |
| Setting resolution               | 2.9999 Vp-p or less: 0.1 m Vp-p /open<br>3.000 Vp-p or more: 1 m Vp-p /open   |
| Accuracy*1                       | ± (1% of amplitude setting [Vp-p] + 2 m Vp-p)/open<br>Conditions: Continuous, 1 kHz sine, amplitude 20 m Vp-p to 20 Vp-p/open                   |
| Setting unit                     | Vp-p, Vpk, Vrms, dBV, dBm   |
| Range                            | Auto, hold (switchable)   |
| Resolution of waveform amplitude | Approx. 16 bit<br>Conditions: Amplitude setting 8 mVp-p/open or more  |

##### DC offset

|                    |   |
|--------------------|---|
| Setting range      | ±10.5 V/open, ±5.25 V/50 Ω  |
| Setting resolution | -2.999 9 V to +2.999 9 V: 0.1 mV/open<br>-3.000 V or less and +3.000 V or more: 1 mV/open |
| Accuracy*1         | ± (   1% of DC offset setting [V]   + 5 mV + 0.5% of amplitude setting [Vp-p])/open       |

##### Waveform Output <FCTN OUT>

|                          |  |
|--------------------------|--|
| On/off control           | On, off (switchable) terminal is in an open condition when off |
| Impedance                | 50 Ω, unbalanced   |
| Short-circuit protection | Protection against short circuit with signal GND               |

##### Synchronization/Sub-output <SYNC/SUB OUT>

|                              |  |
|------------------------------|--|
| Output signals (switchable)  | Reference phase synchronization, burst synchronization, sweep synchronization, sequence step synchronization, sub-waveform, internal modulation synchronization, and off |
| Sub-waveform                 | Analog waveform output independent from the main-output<br>Frequency, phase, amplitude, and offset are also adjustable.  |
| Internal modulation waveform | Modulation waveform at the time of internal modulation oscillation. Amplitude and offset are also adjustable independent from the modulation depth.                      |
| Output voltage               | Each type of synchronized signal: TTL level (low level 0.4 V or less, high level 2.7 V/open or more) Sub-waveform/Internal modulation waveform: -3.3 V to +3.3 V/open    |
| Impedance                    | 50 Ω, unbalanced   |

#### Main Signal Characteristics

##### Sine wave

|                                       |   |
|---------------------------------------|---|
| Amplitude frequency characteristics*1 | Up to 100 kHz : ±0.1 dB<br>100 kHz to 5 MHz : ±0.15 dB<br>5 MHz to 20 MHz : ±0.3 dB<br>20 MHz to 30 MHz : ±0.5 dB<br>30 MHz to 60 MHz : ±0.7 dB*3<br>(Conditions: Amplitude 50 mVp-p to 10 Vp-p/50 Ω, frequency 1kHz reference)   |
| Total harmonic distortion             | 10 Hz to 20 kHz : 0.03% or less typ.<br>Conditions : Amplitude 2 Vp-p/50 Ω, sub-output off, sum up to 7th harmonic, noise is not included.  |
| Harmonic spurious                     | 1 MHz or less : -65 dBc or less typ.<br>10 MHz or less : -60 dBc or less typ.<br>10 MHz to 30 MHz : -60 dBc + 20 dB/dec or less typ. (WF1981/WF1982)<br>10 MHz to 60 MHz : -60 dBc + 20 dB/dec or less typ. (WF1983/WF1984)<br>Conditions : Amplitude 2 Vp-p/50 Ω, sub-output off |
| Non-harmonic spurious                 | 10 MHz or less : -70 dBc or less typ.<br>10 MHz to 30 MHz : -65 dBc or less typ. (WF1981/WF1982)<br>10 MHz to 60 MHz : -65 dBc or less typ. (WF1983/WF1984)<br>Conditions : Amplitude 2 Vp-p/50 Ω, sub-output off   |

##### Square wave

|                       |   |
|-----------------------|---|
| Duty variable range   | Standard : 0.000 1% to 99.999 9% (resolution 0.000 1%)<br>Limited by frequency<br>Jitter 40 ps rms or less typ. (100 Hz or more)<br>Extended : 0.000 0% to 100.000 0% (resolution 0.000 1%)<br>Jitter 1.3 ns rms or less typ. |
| Duty accuracy*1       | Up to 100 kHz : ±0.1% of period (duty setting is 1% to 99%)<br>100 kHz to 1 MHz : ±1% of period (duty setting is 5% to 95%)<br>1 MHz to 3 MHz : ±3% of period (duty setting is 40% to 60%)                                    |
| Rising / falling time | 8.0 ns or less typ, but when continuous oscillation mode  |
| Overshoot             | 2% or less typ.   |

#### Outline dimensional drawing

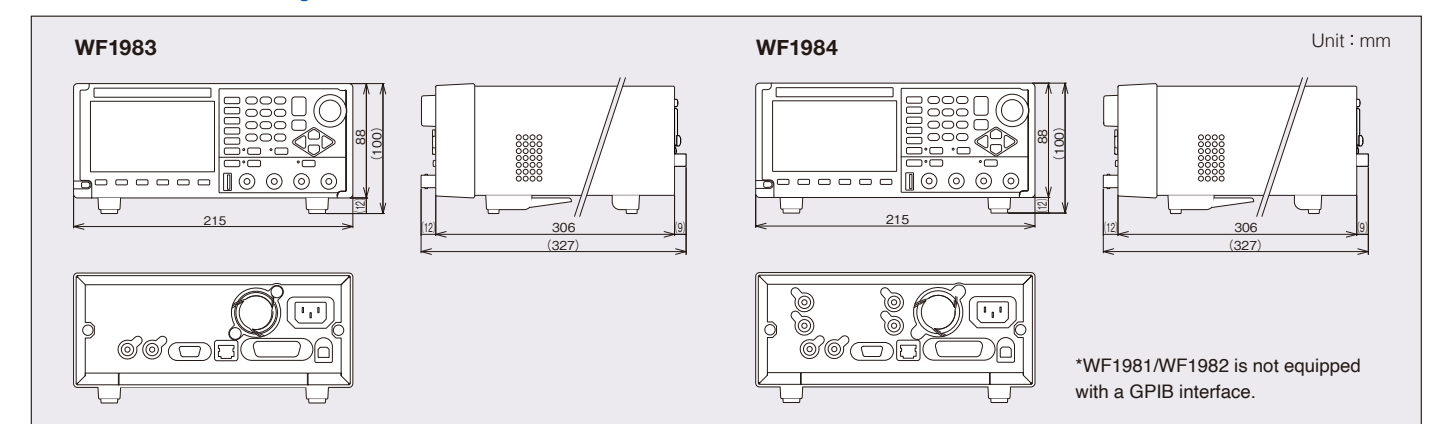

#### Pulse Wave

|                         |   |
|-------------------------|---|
| Available edge waveform | Transition part of the pulse is selectable from cosine, linear, parameter-variable waveform and arbitrary waveform.   |
| Pulse width*4           | Duty setting range: 0.000 1% to 99.999 9% (resolution 0.000 1%)<br>Period setting range: 12 ns to 99.999 9 Ms (resolution 0.000 1% or less of period or 0.01 ns)                        |
| Rising/falling time*4   | 7.7 ns to 59.03 Ms (resolution 4 digits or 0.01 ns)<br>Independent setting of rising and falling edge times<br>Minimum setting value 0.000 1% of period or 7.70 ns, whichever is larger |
| Overshoot*4             | 2% or less typ.   |
| Jitter*4                | 40 ps rms or less typ. (100 Hz or more)<br>1.3 ns rms or less typ. (less than 100 Hz)   |

#### Ramp Wave

|                           |                                     |
|---------------------------|-------------------------------------|
| Setting range of symmetry | 0.00% to 100.00% (resolution 0.01%) |
|---------------------------|-------------------------------------|

#### Parameter-variable Waveform

|                          |  |
|--------------------------|--|
| Steady sine group        | Unbalance sine, Clipped sine wave, CF controlled sine wave, Staircase sine wave, Multiple-cycle sine wave        |
| Transient sine group     | On-phase controlled sine wave, Off-phase controlled sine wave, Chattering-on sine wave, Chattering-off sine wave |
| Pulse group              | Gaussian pulse, Lorentz pulse, Haversine, Sine wave half cycle pulse, Trapezoid pulse, Sin(x)/x                  |
| Transient response group | Exponential rise, Exponential fall, 2nd order LPF step response, Damped oscillation                              |
| Surge group              | Oscillation surge, Pulse surge   |
| Other group              | Trapezoid wave with offset, Double pulse, Half-sine edge pulse, Bottom referenced ramp                           |
| Reusing waveforms        | Parameter-variable waveforms can be used by saving them as arbitrary waveforms                                   |

#### Arbitrary Waveform

|   |   |
|---|---|
| Waveform length                             | 16 words to 32 Mi words (WF1981/WF1982), 16 words to 64 Mi words (WF1983/WF1984) or 2 to 10 000 control points (linear interpolation is performed between control points) |
| Total amount of waveforms that can be saved | Approx. 4 Gi words (common for all channels) Saving of maximum of 4 096 waveforms. Saved to non-volatile memory, saving to USB Flash Drive is possible.                   |
| Resolution of waveform amplitude            | 16 bit  |
| Sampling rate                               | 0 to 120 MS/s (WF1981/WF1982)<br>0 to 240 MS/s (WF1983/WF1984)<br>Resolution: 16 digits or 100 nS/s   |

- \*1 The values are guaranteed values. Other values are nominal or typical values.
- \*2 Convert to arbitrary waveform and use
- \*3 WF1983/1984
- \*4 When the edge waveform is cosine

#### Modulation

|                                       |  |
|---------------------------------------|--|
| Modulation type                       | FM, FSK, PM, PSK, AM, DC offset modulation and PWM<br>PM and PSK are not possible for parameter-variable waveform and arbitrary waveform |
| Modulation source                     | Internal, external (switchable)  |
| Simultaneous use with burst and sweep | Some modulation is possible in the burst and sweep oscillation modes.  |

#### Internal modulation

|  |  |
|--|--|
| Internal modulation waveform               | Except for FSK, PSK: Sine wave, square wave (duty 50%), triangle wave (symmetry 50%), rising ramp wave, falling ramp wave, noise, arbitrary waveform<br>FSK, PSK: Square wave (duty 50%) |
| Internal modulation frequency              | 0 to 5 MHz (Resolution 0.01 μHz)   |
| Internal modulation synchronization output | Output voltage : -3.3 V to +3.3 V/open.  |

#### External modulation

|                  |  |
|------------------|--|
| Modulation input | Except for FSK and PSK<br>Input voltage range: ±1 V full scale<br>Maximum allowable input: ±2 V<br>Input impedance: 10 kΩ, unbalanced<br>Input frequency: DC to 50 kHz (-3 dB)<br>Input connector: BNC receptacle (MOD / ADD IN) |
|                  | FSK and PSK<br>Polarity : Positive, negative (switchable)<br>Input frequency : DC to 5 MHz<br>Input connector : BNC receptacle (TRIG IN)   |

#### Modulation Conditions

|                      |  |
|----------------------|--|
| FM                   | Carrier waveform : Arbitrary waveforms and standard waveforms except for noise, pulse wave, and DC<br>Peak deviation range : 0.00 μHz to less than 15 MHz (WF1981/WF1982) : 0.00 μHz to less than 30 MHz (WF1983/WF1984) (resolution 8 digits or 0.01 μHz) |
| FSK                  | Carrier waveform : Arbitrary waveforms and standard waveforms, except for noise, pulse wave, and DC.<br>Hop frequency range : Within the allowable range of frequency for each carrier waveform (resolution 8 digits or 0.01 μHz).                         |
| PM                   | Carrier waveform : Arbitrary waveforms and standard waveforms except for parameter-variable waveforms, noise, and DC<br>Peak deviation setting range : 0.000° to 180.000° (resolution 0.001°)  |
| PSK                  | Carrier waveform : Arbitrary waveforms and standard waveforms except for parameter-variable waveforms, noise, and DC<br>Setting range of deviation : -1800.000° to +1800.000° (resolution 0.001°)  |
| AM                   | Carrier waveform : Arbitrary waveforms and standard waveforms except for DC. Modulation depth setting range : 0.00% to 100.00% (resolution 0.01%) (DSB-SC and non DSB-SC are available)  |
| DC offset modulation | Carrier waveform : Arbitrary waveforms and standard waveforms<br>Peak deviation setting range : 0 V to 10.5 V/open<br>Peak deviation setting resolution : 3 V < 5 digits or 0.1 mV<br>3 V ≥ 4 digits or 1 mV   |
| PWM                  | Carrier waveform : Square wave and pulse wave<br>Peak deviation setting range :<br>Square wave 0.0000% to 49.9999% (Resolution 0.000 1%)<br>Pulse Wave 0.0000% to 49.9999% (resolution 0.000 1%)   |



## Specifications

### Sweep

|   |   |
|---|---|
| Sweep type                              | Frequency, phase, amplitude, DC offset, and duty  |
| Sweep function                          | One way (ramp), shuttle (triangular) (switchable)<br>Linear, logarithmic (switchable)   |
| Sweep range setting                     | Specify start value and stop value, or center value and span value  |
| Sweep time setting range                | 0.1 ms to 10 000 s (resolution 5 digits or 10 μs)   |
| Operation                               | Start, stop, hold, resume, start value output and stop value output.  |
| Trigger source                          | Internal, external (switchable) Common regardless of sweep type.<br>Trigger delay setting is disabled. Manual trigger available.        |
| Internal trigger oscillator for sweep   | Period setting range 0.1 μs to 10,000 s<br>(resolution 7 digits or 2.5 ns)  |
| Stop level setting                      | Setting range: -100.00% to +100.00%<br>(amplitude full-scale reference and resolution 0.01%) or off                                     |
| Oscillation stop unit when gated single | Cycle, Half Cycle (switchable)  |
| Sweep input/output                      | Sweep sync/marker output (SYNC/SUB OUT)<br>Sweep external control input (Multi-I/O connector)<br>Sweep external trigger input (TRIG IN) |
| Simultaneous with modulation function   | Modulation operation possible at the same time as sweep oscillation   |

### Burst/Gate/Trigger

|  |  |
|--|--|
| Burst mode                                     | Auto burst, trigger burst, gate, triggered gate  |
| Target waveform                                | Auto burst, trigger burst: Arbitrary waveforms and standard waveforms except for Noise and DC.<br>Gate, triggered gate: Arbitrary waveforms and standard waveforms except for DC |
| Mark wave/ space wave number setting range     | 0.5 to 999 999.5 cycles, in 0.5-cycle units or infinite  |
| Oscillation stop unit at gate                  | 1-cycle units, 0.5-cycle units (switchable)  |
| Setting range of start/ stop oscillation phase | -1800.000° to +1800.000° (resolution 0.001°)   |
| Stop level setting range                       | Specifies the signal level when oscillation is stopped.<br>Setting range: -100.00% to +100.00% (amplitude full-scale reference and resolution 0.01%) or off                      |
| Trigger source                                 | Internal, external (switchable). Manual trigger available.   |
| Internal trigger oscillator for burst          | Period setting range: 0.1 μs to 10 000 s<br>(resolution 7 digits or 2.5 ns)<br>Burst external trigger input (used except for auto burst)   |
| Burst external trigger input                   | Polarity Positive, negative, disable (switchable)<br>Input connector: external trigger input terminal.   |
| Trigger delay setting range                    | 0.00 ns to 1 000 s (resolution 8 digits or 100 ps)<br>Latent delay approx. 0.48 μs   |
| Trigger jitter                                 | 300 ps rms or less typ.  |
| Simultaneous with modulation function          | Modulation operation possible at the same time as burst oscillation  |

### Triggers

|                        |  |
|------------------------|--|
| External trigger input | For single sweep, gated single sweep, trigger burst, gate, trigger gate, sequence, and synculator function |
| Input voltage          | TTL level (low 0.8 V or lower, high 2.6 V or higher)   |
| Max. allowable input   | -7 V to +7 V   |
| Min. pulse width       | 50 ns  |
| Input impedance        | 10 kΩ, unbalanced (pull up to approx. +3 V)  |
| Input connector        | BNC receptacle (TRIG IN)   |
| Manual trigger         | For single sweep, gated single sweep, trigger burst, gate, and trigger gate (Not available for synculator) |

### Synculator Function

|                           |   |
|---------------------------|---|
| Input frequency range     | 30 Hz × m to 5 MHz / n<br>(m: frequency division ratio, n: multiplication ratio)      |
| Output frequency range    | 30 Hz to 5 MHz  |
| Setting ranges of m and n | 1 to 64 (for each of m and n)   |
| Input connector           | External trigger input (TRIG IN)<br>Trigger delay setting is disabled                 |
| Phase difference          | The phase between the input external signal and the waveform output can be set freely |

### Sequences

|                              |   |
|------------------------------|---|
| Step control parameters      | Step time, hold operation, jump destination, jump count, step end phase, branch operation, step termination control, step synchronization code output |
| Intra-step channel parameter | Waveform, frequency, phase, amplitude, DC offset and square wave duty, symmetry   |
| Available waveforms          | Sine wave, square wave, ramp wave, noise, DC and arbitrary waveform<br>Parameter-variable waveforms can be used by saving them as arbitrary waveforms |
| Max. number of waveforms     | 1023 (each channel)   |
| Number of sequences          | 99 sets (saved to non-volatile memory)  |
| Max. number of steps         | 1023 steps at a maximum per sequence  |
| Step time setting range      | 0.1 ms to 1 000 s (resolution 5 digits or 0.01 ms)  |
| Intra-step operation         | Constant, keep, linear interpolation<br>(excluding waveform switching)  |
| Jump count setting range     | 1 to 9999 or infinite   |
| Step end phase setting range | 0.000° to 360.000°(CH1 reference phase, resolution 0.001°)<br>or disabled   |
| Branch operation             | Branches to the specified step when the branch is detected.   |
| Control at step end          | Stop or move to the next step   |

### 2 Channel Coordination Operation (WF1982/WF1984)

|  |  |
|--|--|
| Channel mode                                   | 2 channels independent, 2-phases, constant frequency difference, constant frequency ratio, differential output (Oscillation with the same frequency and amplitude reverse phase waveform. DC offset changes to the same polarity.), differential output 2 (Same as differential output but DC is reversed polarity.) |
| Same value, same operation                     | 2 channels can be set simultaneously   |
| Frequency difference setting range             | WF1981/WF1982: 0.00 μHz to less than 30 MHz<br>WF1983/WF1984: 0.00 μHz to less than 60 MHz<br>CH2 frequency - CH1 frequency (Resolution: 0.01 μHz)   |
| Frequency ratio N:M setting range              | 1 to 9 999 999 (for both N and M)<br>N:M = CH2 frequency:CH1 frequency   |
| Phase synchronization operation                | Auto executed when the channel mode is changed   |
| Time difference between channels for 2-phase*1 | ±20 ns or less (±10 ns or less typ.)<br>Conditions: Same waveform (sine or square)   |

### Other I/Os

#### External 10 MHz frequency reference input

|                      |                                   |
|----------------------|-----------------------------------|
| Input voltage        | 0.5 Vp-p to 5 Vp-p                |
| Max. allowable input | 10 Vp-p                           |
| Input impedance      | 300 Ω, unbalanced, AC coupled     |
| Input frequency      | 10 MHz (±0.5% (±50 kHz))          |
| Input waveform       | Sine or square wave (50%±5% duty) |
| Input connector      | BNC receptacle (10 MHz REF IN)    |

#### Frequency reference output(Multiple equipment synchronization)

|                  |                                |
|------------------|--------------------------------|
| Output voltage   | 1 Vp-p/50 Ω square wave        |
| Output impedance | 50 Ω, AC coupled               |
| Output frequency | 10 MHz                         |
| Output connector | BNC receptacle (10MHz REF OUT) |

#### External addition input

|                      |   |
|----------------------|---|
| Addition gain        | x0.4, x2, x10, or off (switchable)<br>The maximum output range is fixed to 0.8 Vp-p for x0.4, 4 Vp-p for x2, and 20 Vp-p for x10. |
| Input voltage        | -1 V to +1 V  |
| Max. allowable input | ±2 V  |
| Input frequency      | DC to 10 MHz (-3 dB)  |
| Input impedance      | 10 kΩ, unbalanced   |
| Input connector      | BNC receptacle (MOD/ADD IN)   |

#### Multi-I/O

|                     |  |
|---------------------|--|
| Multi-I/O connector | Sweep external control, sequence external control<br>(dedicated cable is optional) |
|---------------------|--|

### Other Functions

|  |   |   |
|--|---|---|
| Phase synchronization                        | Restart the output waveforms of all channels from the set phase   |   |
| Synchronization of Multiple Units            | Max. 6 units  |   |
| User-defined Units                           | Function  | Set and display settings in any unit based on a specified conversion expression             |
|  | Setting items   | Frequency (Hz), cycle (sec), amplitude (Vp-p, Vpk), DC offset (V), phase (deg) and duty (%) |
|  | Conversion expression   | [(setting target value)+n]×m or [log10(setting target value)+n]×m                           |
|  | Unit string   | Maximum 4 characters  |
| Setting Value Upper and Lower Limit Function | Function: Limit the upper and lower limits of setting values. However, this is not applied to external addition.<br>Setting target: Frequency, negative and positive values of output voltage (amplitude setting [Vp-p] ÷ 2 + DC offset setting [V]), phase, duty.<br>Setting range and resolution: In accordance with the setting range of each target |   |
| Setting saving memory                        | 10 sets (saved to non-volatile memory)<br>Saving to USB Flash Drive is possible.  |   |
| Remote Interfaces                            | GPIO: IEEE-488.1, IEEE-488.2 (WF1983/WF1984)<br>USB: USBTMC, USB 1.1 Full Speed<br>LAN: TCP/IP, 10/100Base-T  |   |

### Control software

|             |                                  |   |
|-------------|----------------------------------|---|
| Function    | Remote control                   | Setting, saving, and reading parameters                   |
|             | Status monitor                   | Monitor and display the status of connected devices       |
|             | Creating arbitrary waveform data | Waveform generation, editing, transfer, and display       |
| Environment | Edit a sequence                  | Edit a sequence, modifying, saving transfer, and display  |
|             | Hard disk                        | 64MB or more  |
|             | OS                               | Windows10/11 (64bit, Japanese version/English version)    |
|             | Interface                        | USB/LAN   |
|             | Software component               | Microsoft .NET Framework 4.8 or later<br>VISA environment |

### General

|   |  |
|---|--|
| Display                                       | 4.3 inch TFT color LCD   |
| I/O ground                                    | -Signal grounds for waveform output, synchronization/sub-output, external modulation/addition input are insulated from the enclosure. (These signal grounds are shared within the same channel.)<br>-The signal ground for the external 10MHz frequency reference input (10MHz REF IN) is insulated from the enclosure.<br>-Each of the signal grounds of CH1, CH2, and 10 MHz reference input are independent.<br>-The maximum withstand voltage: 42 Vpk (DC+AC peak) |
| Power supply                                  | 100 V to 240 V AC, 50 Hz/60 Hz ±2 Hz   |
| Power consumption                             | WF1981/WF1983: 50 VA or less<br>WF1982/WF1984: 75 VA or less   |
| Overvoltage category                          | II   |
| Ambient temperature/humidity range conditions | 0°C to +40°C, 5%RH to 85%RH (Where absolute humidity is 1 g/m³ to 25 g/m³, non-condensing)   |
| Pollution degree                              | 2  |
| Installation location                         | Indoor use   |
| Dimension                                     | 215 (W) x 88 (H) x 306 (D) mm (excluding protrusions)  |
| Weight  | Approx. 1.8 kg (excluding accessories)   |
| Accessories                                   | Safety Information, Quick start guide, Power cable set   |

### Options

| Models      | Products                          |
|-------------|-----------------------------------|
| PA-001-1318 | Multi-I/O Cable                   |
| PA-001-3838 | Rack Mount Kit (EIA, for 1 unit)  |
| PA-001-3839 | Rack Mount Kit (EIA, for 2 units) |
| PA-001-3840 | Rack Mount Kit (JIS, for 1 unit)  |
| PA-001-3841 | Rack Mount Kit (JIS, for 2 units) |

## Modification available

- **Maximum output voltage expansion**  
30 Vp-p/open, output impedance 5 Ω setting
- **Resonance point tracking function**  
For driving piezoelectric devices with power amplifiers



WAVE FACTORY



## Multifunction Generator

### WF1967/ WF1968

200  
MHz



WF1968

#### High performance and functionality

- ◆ 0.01  $\mu$ Hz to 200 MHz
- ◆ Max.20 Vp-p/open
- ◆ Low jitter, low distortion
- ◆ Sub channel : 2-ch model as 4 phase signal generator
- ◆ parameter-variable waveform, sequence function, high speed/large capacity arbitrary waveform

## High Speed Bipolar Amplifier / Bipolar Amplifier

*Amplify the output of function generator*

### High Speed Bipolar Amplifier HSA series Stable output for capacitive / inductive load.

Max.  
1 MHz



- ◆ 4-quadrant operation
- ◆ Low output impedance
- ◆ Gain setting, polarity switching, DC bias voltage setting

| Model    | Frequency     | Voltage  | Current   |
|----------|---------------|----------|-----------|
| HSA42011 | DC to 1 MHz   | 150 Vp-p | 3 Ap-p    |
| HSA42012 | DC to 1 MHz   | 150 Vp-p | 6 Ap-p    |
| HSA42014 | DC to 1 MHz   | 150 Vp-p | 12 Ap-p   |
| HSA42051 | DC to 500 kHz | 300 Vp-p | 2.83 Ap-p |
| HSA42052 | DC to 500 kHz | 300 Vp-p | 5.66 Ap-p |

### Bipolar DC Power Supply BP series Constant voltage / Constant current Max. current $\pm 100$ A

$\pm 10$  A



$\pm 30$  A

- ◆ Output voltage :  $\pm 60$  V、120V p-p  
Output current :  $\pm 10$  A to  $\pm 100$  A (10 models)
- ◆ Frequency : DC to 150 kHz (CV mode)  
: DC to 70 kHz (CC mode)
- ◆ Two mode selectable, Constant voltage / Constant current
- ◆ Up to 255 steps sequence function
- ◆ Response calibration function, Voltage / Current limiter, measurement function

\*Note: The contents of this catalog are current as of July 26th, 2024.  
Product appearance and specifications are subject to change without notice.  
Before purchase, contact us to confirm the latest specifications, price and delivery date.

## NF Corporation

Head Office  
6-3-20 Tsunashima Higashi, Kohoku-ku, Yokohama 223-8508, Japan  
Phone : +81-45-545-8128 Fax : +81-45-545-8187  
<http://www.nfcorp.co.jp/english/>