

INSTRUCTION MANUAL

VIBRATION ANALYZER

VA-12



3-20-41 Higashimotomachi, Kokubunji, Tokyo 185-8533, Japan

<https://www.rion.co.jp/english/>

Organization of this manual

This manual describes the features, operation, and other aspects of the Vibration Analyzer VA-12. If the unit is used together with other equipment to configure a measurement system, consult the documentation of all other components as well. The section starting on page v contains important safety precautions. Be sure to read this section carefully.

This manual contains the following sections.

– General Operation –

Outline

Gives an overview of the unit.

Controls and Features

Briefly identifies and explains the operation panel keys, connectors on the top and bottom, and other parts of the unit.

Preparations

Describes how to prepare the unit for use, including information on making connections, power-up, and inserting the SD card.

Menu Operation

Describes how to use the menus of the unit.

Analysis Functions

Describes the different analysis function available with the unit and how to select them.

Measurement in Vibration Meter Mode

Describes the display screen contents and operation steps in vibration meter mode.

Measurement in Time Waveform Mode

Describes the display screen contents and operation steps in time waveform mode.

Measurement in FFT Mode

Describes the display screen contents and operation steps in FFT mode.

Recording Waveform Data

Describes the waveform recording function.

Recalling Stored Data

Describes how to recall data that were saved from the various measurement screens, and how to view recalled data.

Saving the Screen as a BMP File

Describes how to save the currently displayed screen as a BMP file.

Printing

Describes how to print data from the measurement screen and recall screen.

– Advanced Operation –

Trigger Functions

Describes the use of trigger signals and the relationship between triggering and various measurements.

Overlay Display

Describes how to use the overlay function in FFT mode.

Setup Files and Initialization

Describes how to use setup files and lists the default settings for various items.

Power Supply

Provides information about powering the unit.

Using the Backlight

Describes how to use the display backlight.

Status Display

Lists the various status indication symbols and other indicators of the unit.

SD Card

Describes how to use an SD card with this unit and explains the folder structure for storing data on the card.

Data File Structure

Describes the structure of data files stored on the SD card.

Setting Commands

Describes the setting commands that express various measurement and display parameters of the unit.

– Other Information –

Specifications

Lists the technical specifications of the unit.

Index

* Company names and product names mentioned in this manual are usually trademarks or registered trademarks of their respective owners.

CE

Note: CE requirements are met provided that a core filter is fitted to every cable.

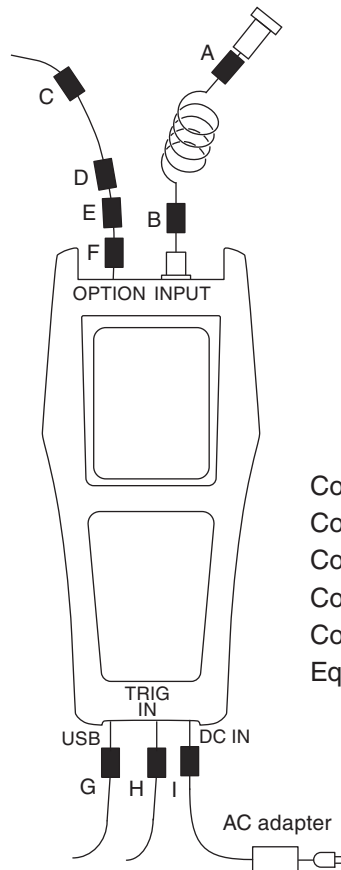

Core A: E04SR130525A (SEIWA)
Core B: ZCAT2035-0930 (TDK)
Core C, G, H: E04SS201010 (SEIWA)
Core D, E, F: ZCAT2017-0930 (TDK)
Core I: ZCAT2436-1330 (TDK)
Equivalent product

This product can be used in any areas including residential areas.

To conform to the EU requirement of the Directive on Waste Electrical and Electronic Equipment, the symbol mark on the right is shown on the instrument.



FOR SAFETY

In this manual, important safety instructions are specially marked as shown below. To prevent the risk of death or injury to persons and severe damage to the unit or peripheral equipment, make sure that all instructions are fully understood and observed.

⚠ WARNING	Disregarding instructions printed here incurs the risk of death or severe injury to persons.
●	

⚠ Caution	Disregarding instructions printed here incurs the risk of injury to persons and/or damage to peripheral equipment.
●	

Important	Disregarding instructions printed here incurs the risk of damage to the product.
●	



Note	Denotes special information that is helpful in utilizing the capabilities of the unit but that is not directly related to safety.
●	



WARNING

Be careful around rotating machinery.

- When making measurements on exposed rotating parts or power train parts of machinery, proceed with utmost care to ensure that the accelerometer or accelerometer cable does not get caught in the machine.
- When making measurements on exposed rotating parts or power train parts of machinery, do not use the shoulder belt. If they are rolled in the machine, a dangerous accident is caused.

Precautions

- Operate the unit only as described in this manual.
- Do not touch any parts of the unit other than necessary for operation.
- Do not drop the unit. Protect it from shocks and vibration.
- The permissible ambient temperature range for operation of the unit is -10°C to $+50^{\circ}\text{C}$. Relative humidity must be 90% RH or less.
Do not use or store the unit in locations which may be subject to water, dust, direct sunlight, high temperatures or humidity. Also protect the unit from air with high salt or sulphur content, gases or the influence of chemicals.
- The power cord used to connect the optional AC adapter to an AC outlet is a 100 V AC cord for domestic use in Japan, which is compliant with Japanese laws and electrical safety standards. Do not use this power cord outside Japan or with any voltage other than 100 V AC. Otherwise, RION cannot guarantee the safety of the equipment. Use a power cable that is compliant with the laws and electrical safety standards of your location.
- If you notice any sign of a problem during use, disconnect the AC adapter, remove the battery, and contact your supplier.
- Do not forget to turn the unit off after use. Remove the batteries if the unit is not to be used for some time.
- When disconnecting cables, always hold the plug and do not pull the cable.
- To clean the unit, use only a dry cloth or a cloth lightly moistened with water. Do not use chemical cleaning cloths, solvents or alcohol-based cleaners to prevent the possibility of deformation and discoloring.
- Do not tap the LCD panel or other surfaces of the unit with a pointed object such as a pencil, screwdriver, etc.
- Do not insert any objects such as pins, metal scraps, conducting plastic etc. into any opening on the unit.
- Do not disassemble the unit or attempt internal alterations.
- In case of malfunction, do not attempt any repairs. Note the condition of the unit clearly and contact the supplier.
- When disposing of the unit or the accessories (accelerometer PV-57I or others), follow your national and local regulations regarding waste disposal.

Contents

FOR SAFETY.....	v
General Operation.....	1
Outline.....	3
Block diagram.....	4
Controls and Features.....	5
Front Panel.....	5
Top Panel.....	8
Bottom Panel.....	9
Rear Panel.....	10
Preparations.....	11
Power supply.....	11
Connecting the accelerometer.....	14
Inserting the SD card.....	17
Setting the current date/time.....	18
Selecting the language.....	19
Using the shoulder belt.....	20
Attaching the sensor to the protective cover.....	20
Connection to a printer (BL-112UI).....	21
Menu Operation.....	22
Menu structure.....	22
Menu flow diagram.....	23
Menu operation.....	24
Analysis Functions.....	28
Available analysis types.....	28
Switching between analysis functions.....	29
Measurement in Vibration Meter Mode.....	31
Reading the display.....	32
Changing measurement parameters and display parameters.....	37
Performing measurement.....	39
Storing measurement data.....	40

Measurement in Time Waveform Mode.....	41
Reading the display.....	42
Changing measurement parameters	48
Zooming/moving the display	51
Performing measurement.....	53
Storing measurement data.....	54
Measurement in FFT Mode.....	55
Reading the display.....	56
Changing measurement parameters and display parameters ...	65
Zooming/moving the display	69
Performing measurement.....	71
Storing measurement data.....	75
Recording Waveform Data	77
Making waveform recording settings	77
Recording waveform data	77
Re-analyzing waveform data.....	78
Recalling Stored Data	79
Procedure for recalling stored data	79
Reading the recall screen.....	82
Changing the display	83
Deleting stored data.....	84
Saving the Screen as a BMP File.....	85
Saving the measurement screen or recall screen	85
Screen hard copy	85
Displaying a BMP file.....	86
Printing.....	87
Printing the measurement screen	87
Printing the recall screen.....	87
Printing stored data continuously.....	88
Advanced Operation.....	89
Trigger Functions	91
Trigger operation modes	91
Making trigger settings.....	93
Performing measurement with repeat trigger	97
Performing measurement with single trigger.....	101
Performing measurement with time trigger.....	104

Overlay Display.....	110
Activating the overlay display	110
Canceling the overlay display	111
Reactivating the overlay display.....	111
Setup Files and Initialization.....	112
Resume function	112
Loading a setup file at startup.....	112
Initialization	113
Using setup files.....	113
Setup file content example	116
Setting items.....	117
Power Supply	119
Battery-powered operation and external power supply operation ..	119
Batteries	119
External power supply (AC adapter).....	120
Auto shut-off function.....	120
Using the Backlight.....	121
Selecting the backlight brightness.....	121
Selecting the backlight auto-off delay	121
Using the backlight.....	121
Status Display	122
Symbol List	122
LED Indicator.....	123
SD Card	124
SD card data capacity	124
Formatting an SD card.....	124
Data transfer	125
Folder structure.....	126
Data File Structure.....	127
Data store files.....	128
WAVE files	133
Setting Commands.....	139
Setting command format.....	139
Command List.....	140
Command Description.....	142

Other Information 151
 Specifications 152
 Index 163

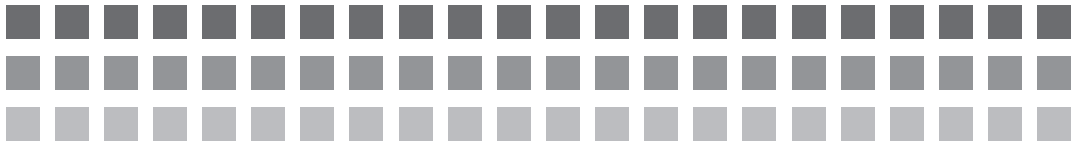

General Operation



Outline

The VA-12 is a portable vibration analyzer with FFT analysis function specially designed for making measurements in the field.

It comes with the Piezoelectric Accelerometer PV-57I equipped with magnetic attachment.

Because the VA-12 is equipped with the constant-current power supply, accelerometers with an integrated preamplifier (CCLD type) can be connected. Also, the charge output type accelerometers can be connected by combining VP-40 with VA-12.

The VA-12 offers three analyzer modes: vibration meter mode, time waveform mode, and FFT mode.

In vibration meter mode, acceleration, velocity, displacement, acceleration peak, and acceleration crest factor can be measured simultaneously.

In time waveform mode, the waveform of acceleration, velocity, displacement or acceleration envelope curve can be displayed with up to 8192 samples.

In FFT mode, the frequency analysis of acceleration, velocity, displacement or acceleration envelope curve can be displayed with up to 3200 spectral lines.

The TFT color display has a resolution of 240 × 320 dots and is designed to be easy to read, regardless of whether the unit is used indoors, outdoors, or in dark locations. Membrane switches ensure easy operation, and an overload LED indicator is also provided.

The buffer performance of the unit improves if the supplied protective cover is installed. (When shipping the VA-12, the protective cover is installed.)

The SD card is used for the memory medium.

Features

- DSP chip performs digital integration and rms processing
- Simultaneous display of acceleration, velocity, displacement, acceleration peak, and acceleration crest factor in vibration meter mode
- 24-bit A/D converter achieves 80 dB dynamic range for FFT analysis
- Overlay display of measurement data and recall data possible in FFT mode
- 1000 data × 100 store names available for data of any type
- Data store function with specified start time and store interval

- Data are stored on handy SD cards
- Setup files allow specifying five different sets of parameters
- Five setup files can be stored as a group on an SD card
- Display image can be captured as a BMP file
- When connected to a computer via the optional USB cable, the SD card in the unit is recognized as a removable disk

Block diagram

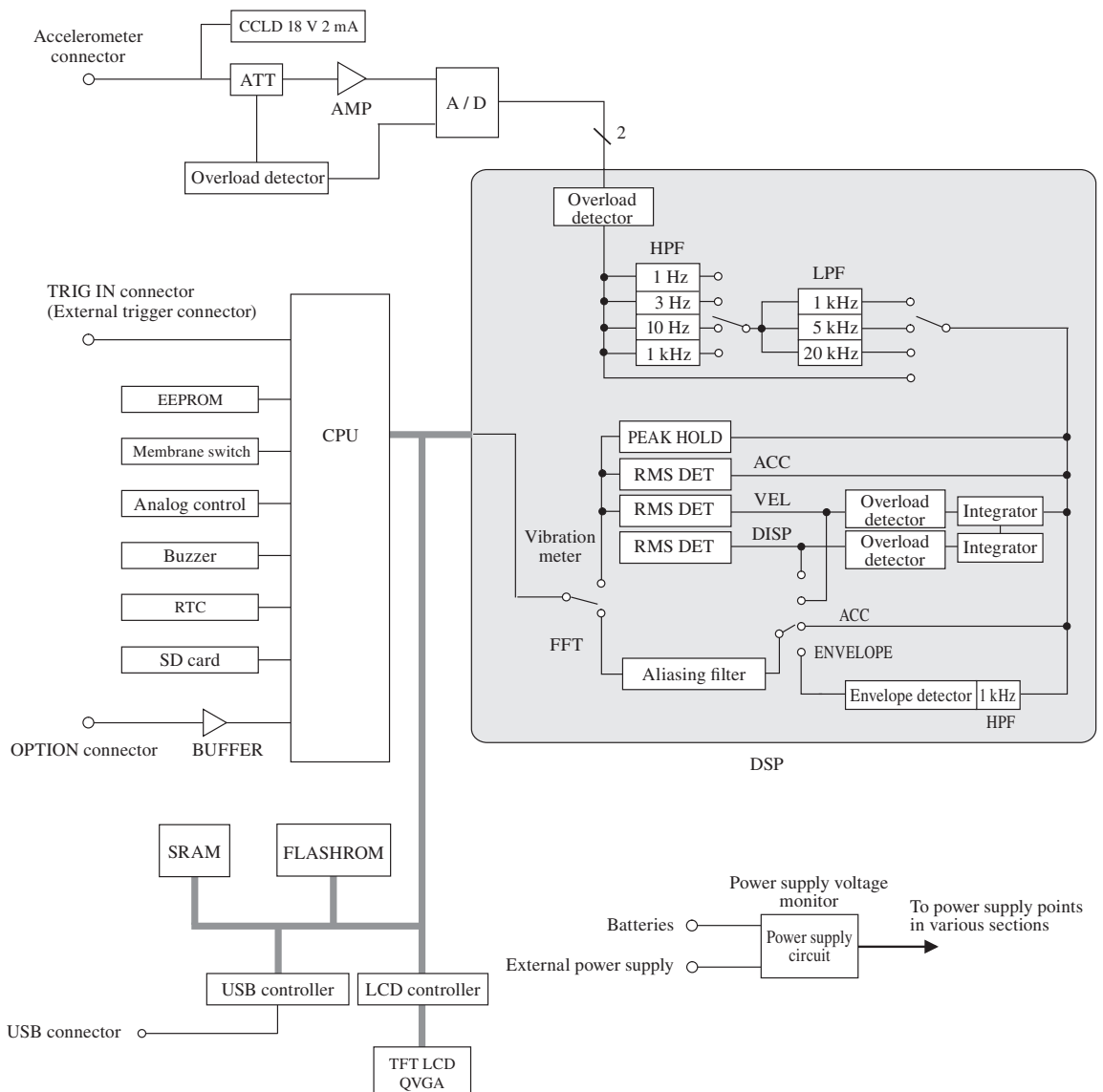

Controls and Features

Front Panel

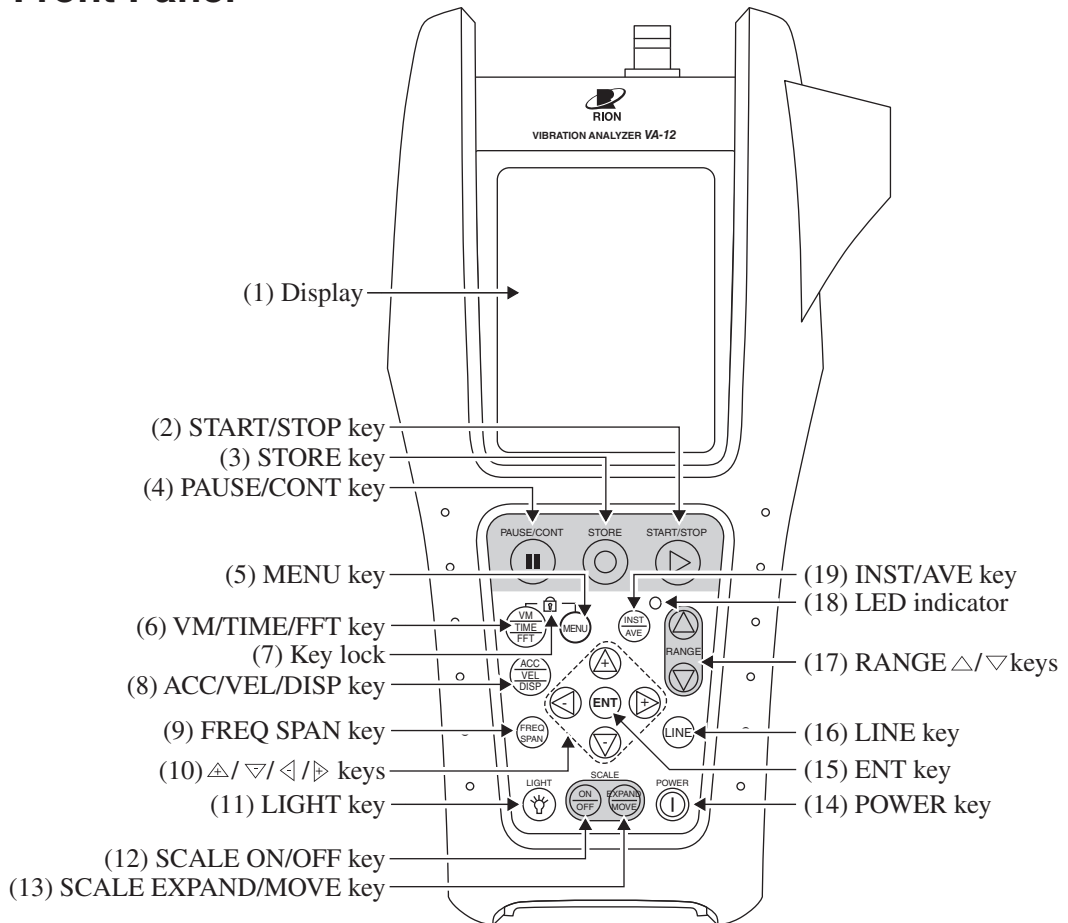

* The illustration shows the unit with the protective cover attached.

(1) Display

Shows measured data, menu screens and other information.

The sections of the display are named as shown on the right.

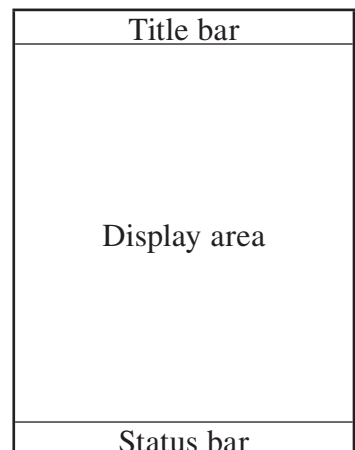

Important
Avoid operating the keys with your fingernail or a pointed object such as the tip of a ballpoint pen, because this can lead to faster degradation and can result in operation failure.

(2) START/STOP key

Serves to start and stop the measurement. The key is also used to return to the measurement screen from a menu screen.

(3) STORE key

Serves to store data on SD card. The key is also used to start the time trigger operation when the time trigger function (see page 95) is used.

(4) PAUSE/CONT key

Serves to pause and resume the measurement.

(5) MENU key

Gives access to the menus for changing measurement parameters.

(6) VM/TIME/FFT key

Serves to select the analysis mode.

(7) Key lock

Pressing the VM/TIME/FFT key for 2 seconds while holding down the MENU key sets the unit to the key lock condition where all operation keys are disabled.

(8) ACC/VEL/DISP key

Serves to select measurement data type (acceleration/velocity/displacement/envelope).

(9) FREQ SPAN key

Serves to change the frequency span in time waveform mode and FFT mode.

(10) \triangle / ∇ / \triangleleft / \triangleright keys

These keys are used for various functions, such as selecting menu items, moving the cursor, changing the display zoom factor, etc.

(11) LIGHT key

Serves to control the display backlight. Each push of the key toggles between on and off. The backlight brightness can be set from the [System] menu.

(12) SCALE ON/OFF key

In time waveform mode and FFT mode, this key serves to switch the display scaling function (see pages 51 and 69) on and off.

To zoom the display in graph mode, press this key to enable scaling, and then use the \triangle / ∇ / \triangleleft / \triangleright keys.

(13) SCALE EXPAND/MOVE key

When display scaling is enabled, this key serves to switch between zoom (expand/shrink) mode and move mode.

(14) POWER key

Serves to turn the unit on and off.

(15) ENT key

This key serves to confirm a menu selection and is also used for other functions such as saving the recall screen as a BMP file. Hold down the key for about 1 second.

(16) LINE key

In time waveform mode and FFT mode, this key serves to change the number of analysis lines.

(17) RANGE \triangle / ∇ keys

These keys serve to select the input range for measurement.

(18) LED indicator

Shows operation and status information for the unit, using the colors red, blue, green, and yellow, as well as blinking.

(19) INST/AVE key

In FFT mode, this key serves to switch between the instantaneous value display and the operation type selected from a menu (linear average, exponential average, maximum hold).

Top Panel

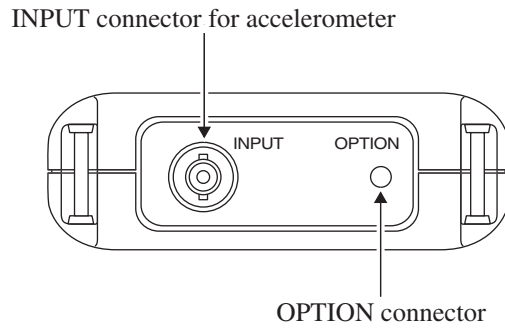

INPUT connector

The supplied Piezoelectric Accelerometer PV-57I or another accelerometer is to be connected here.

(Other supported accelerometers include PV-91C etc.)

OPTION connector

Serves for future expansion (currently not used).

Bottom Panel

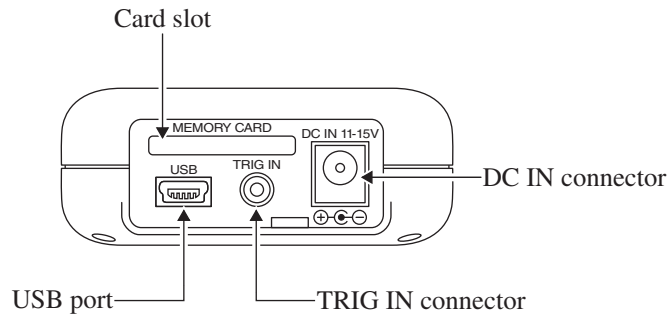

Card slot

The SD card is to be inserted here. This allows storing data and exporting data to a computer. The card slot is also used for upgrading the system firmware etc.

USB port

Using the optional USB Mini B - B cable CC-97, the dedicated USB Printer BL-112UI can be connected here.

The port also serves for connection to a computer, using an optional USB A - Mini B cable. In this case, the SD card inserted in the VA-12 is recognized as a removable disk by the computer.

TRIG IN connector

Serves for the input of an external trigger signal. This allows controlling the measurement based on certain trigger conditions.

DC IN connector

The optional AC adapter NC-99 series can be connected here for powering the unit from an AC source (90 V to 240 V).

Important

Do not use an adapter other than the NC-99 series to prevent the risk of damage.

Rear Panel

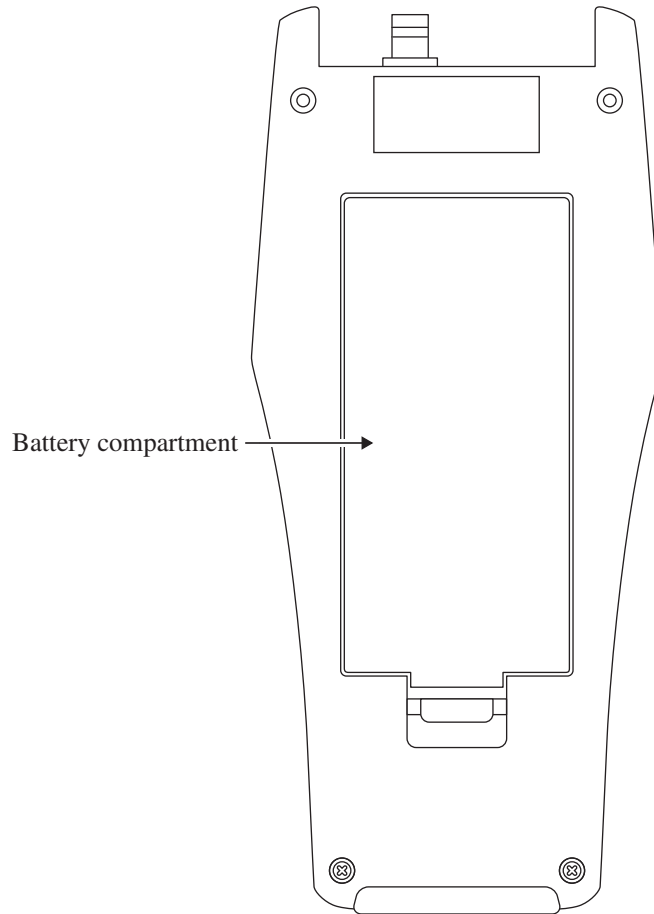

Battery compartment

Insert eight IEC R6 (size AA) batteries here.

Preparations

Power supply

The unit can be powered from eight IEC R6 (size AA) batteries (alkaline or manganese), or the optional AC adapter NC-99 series.

Inserting the batteries

1. Open the cover of the battery compartment, as shown in the illustration below.
2. Insert eight IEC R6 (size AA) batteries with correct polarity, as shown inside the battery compartment.

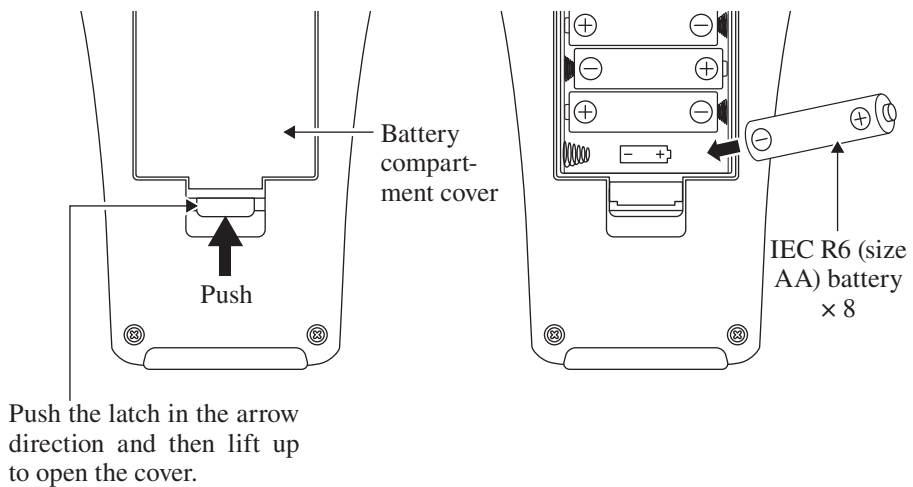

3. Replace the battery compartment cover.

Important

Take care not to mix up [+] and [-] polarity when inserting the batteries.

Replace all eight batteries at the same time, and do not mix battery types, to prevent the risk of damage.

When not in use, remove the batteries from the unit to prevent the risk of damage by battery fluid leakage etc.

AC adapter

To use the optional AC adapter, connect it to the unit as shown below.

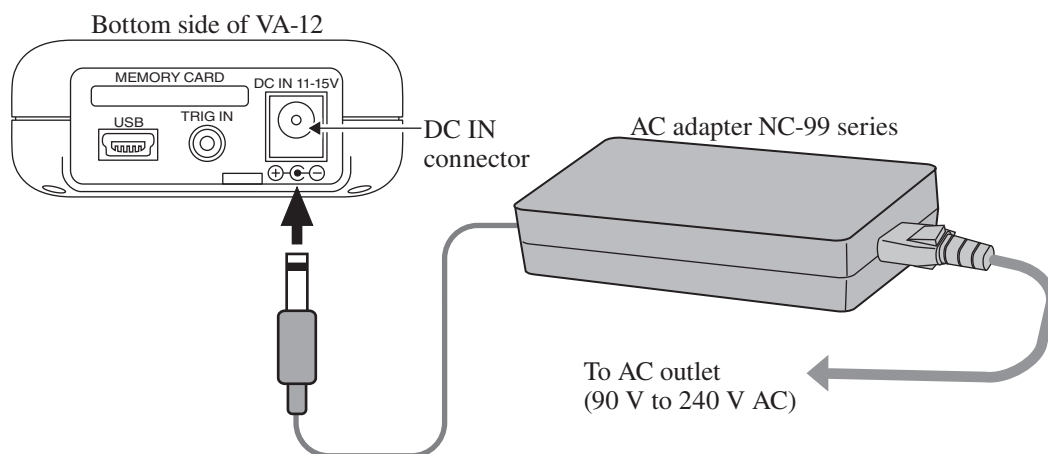

Important

Do not use an adapter other than the NC-99 series to prevent the risk of damage.

Note

When the AC adapter is connected to the unit, power will be supplied from the adapter, also if batteries are inserted. (The AC adapter has priority.)
If power to the adapter is interrupted (such as during a power failure), the unit will automatically switch to battery-powered operation.

Power-up

Hold down the POWER key (see page 5) for at least 1 second to turn the unit on.

If the unit is powered from batteries only, the remaining battery capacity indicator is shown on the status bar (see page 5). If the unit is powered from the AC adapter, the AC power symbol  is shown. (See the “Status indication” section.)

When the remaining battery capacity indicator shows  and is flashing, replace the batteries with a fresh set. (See the “Power supply” section.)

Important

The unit is equipped with an internal rechargeable backup battery to maintain clock data. The backup battery is charged while power to the unit is on. Clock data can be maintained for approximately up to 30 days (after the battery has been charged for 24 hours).

The life of the internal rechargeable battery is limited. You should have the battery replaced about once every five years. (Please contact your supplier or an authorized RION service station.)

Power-off

Hold down the **POWER** key for several seconds until the power-off screen as shown below appears, and then release the **POWER** key.



The RION logo separates into two parts and goes off.

Power-off screen

Note

After turning the unit off, wait at least 10 seconds before turning it on again.

Power-on mode

Opening the battery compartment and removing the two batteries at center gives access to the power-on mode switch as shown below.

Normally the “A” position is used.

Setting this switch to the “B” position allows the VA-12 to turned on simply by supplying power to the DC IN connector.

In this case, the POWER key on the front panel of the VA-12 has no effect.

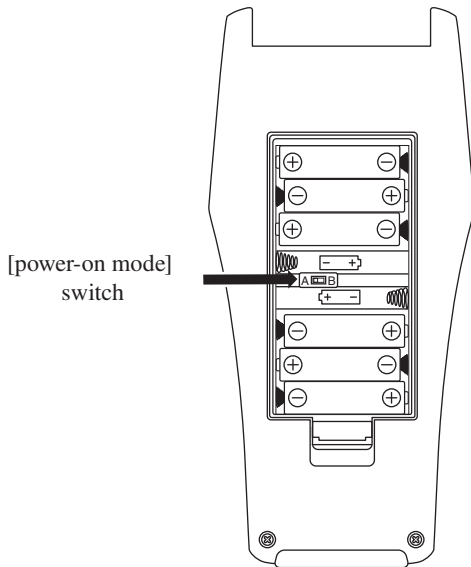

Important

When setting the power-on mode switch to the “B” position, remove the batteries from the unit for prevention of the battery leakage.

Connecting the accelerometer

Connect the accelerometer

1. Connect the piezoelectric accelerometer as shown below.

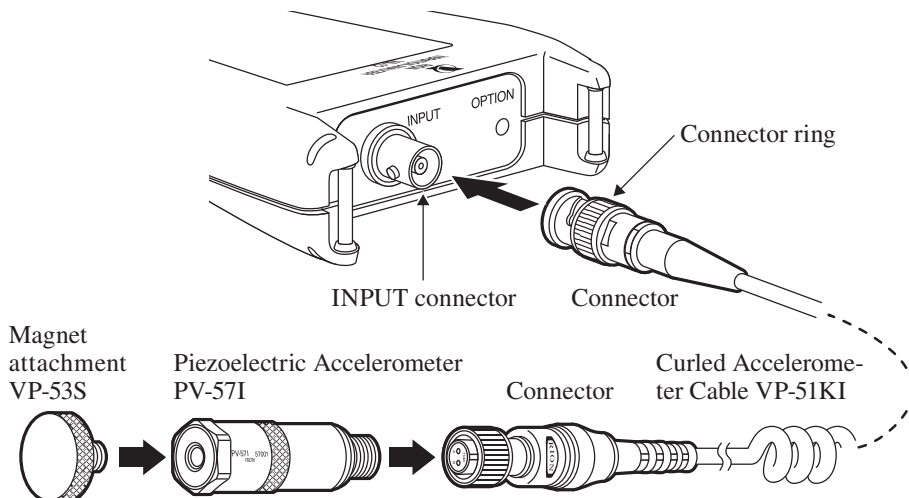

⚠ Caution

The magnet attachment VP-53S is extremely powerful (0.8 kG to 1 kG). Proceed with care to prevent the risk of injury when bringing the attachment in contact with the measurement object.

Keep the magnet attachment at least 50 centimeters away from any magnetic media such as memory cards. Otherwise, data can be destroyed.

Note

Besides the supplied Piezoelectric Accelerometer PV-57I, other accelerometers with an integrated preamplifier (CCLD type) of PV-91C and so on can also be used. In this case, a BNC adapter (VP-52C), low-noise cable (VP-51A, VP-51L) and other accessories may be required.

The Piezoelectric Accelerometer PV-57 or PV-57A cannot be used.

Before starting to use the unit, the piezoelectric accelerometer sensitivity must be set. For details about the setting procedure, see the “Making sensor settings” section on the next page.

Note

For installation of an attachment using a set screw, tighten the set screw first on the piezoelectric accelerometer and then mount the attachment.
--

2. Insert the connector plug of the cable into the INPUT connector on the VA-12, and rotate the connector ring clockwise to firmly lock the plug.
3. If the accelerometer has been changed, use the supplied calibration chart to make the sensitivity setting (see the “Making sensor settings” section below).
4. Lightly press the accelerometer and verify that the display indication changes.
5. Use the RANGE \triangle / ∇ keys and verify that the display indication changes.

Making sensor settings

Use the supplied calibration chart of the accelerometer you intend to use, and make the sensitivity setting by performing the following steps.

1. From the [Analog Input] menu screen, select [Sensor Selection] and then [PV-57I] or [Other].
2. Set [Sensitivity] to the sensitivity value given on the calibration chart.

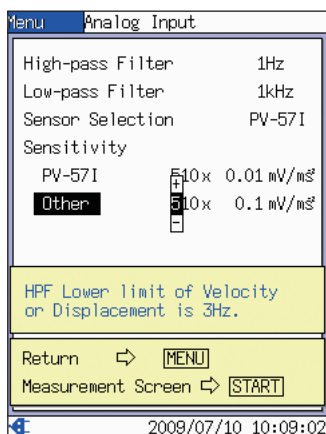

[Analog Input] menu screen

Use the \leftarrow / \rightarrow keys to move to the item to change, and use the \triangle / ∇ keys to change the numeric value.

Holding down the \triangle / ∇ keys changes the value more quickly.

When the correct value has been set, press the ENT key to accept the setting.

To cancel the procedure without changing the current setting, press the START/STOP key or the \leftarrow key. The cursor returns to the menu item name, and the setting value reverts to the previous condition.

Note

When selecting [PV-57I], a popup window appears, asking whether you want to change the sensitivity setting. Also, note that the factor cannot be changed.

Inserting the SD card

Insert the SD card into the card slot on the bottom of the unit with the label of the card facing up. Push the card in until it is locked in place.

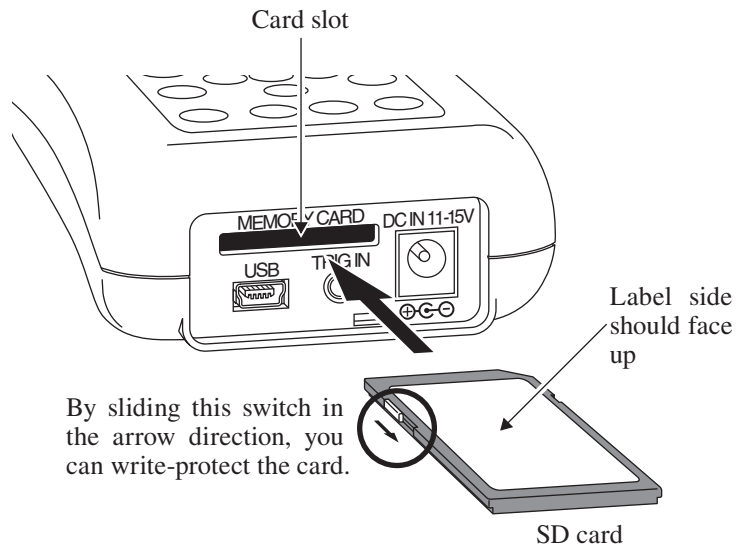

Important

Take care to insert the SD card with correct orientation.

If the SD card is removed while data are being read from or written to the card, the data may be destroyed.

Do not use SD cards other than those specified by Rion, to avoid the risk of malfunction.

Removing the SD card

When you push the SD card a bit further in, the card is released and pops out of the card slot.

Setting the current date/time

1. Turn the VA-12 on.
2. Press the MENU key to bring up the [Menu List] screen.

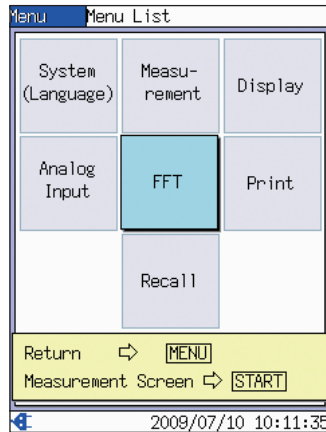

[Menu List] screen

3. Use the \triangle / ∇ / \triangleleft / \triangleright keys to select [System (Language)] and press the ENT key. The [SYSTEM] menu screen is displayed.

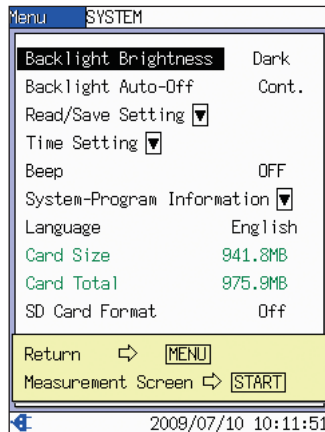

[SYSTEM] menu screen

- Use the \triangle / ∇ keys to select [Time Setting] and press the ENT key. The [System/Current Time] screen appears.

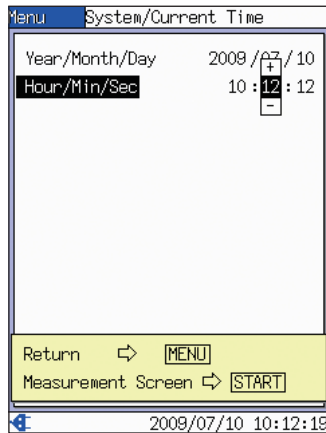

Use the \triangleleft / \triangleright keys to move to the item to change, and use the \triangle / ∇ keys to change the numeric value.

Holding down the \triangle / ∇ keys changes the value more quickly.

When the correct value has been set, press the ENT key to accept the setting.

To cancel the procedure without changing the current setting, press the START/STOP key or the \triangleleft key. The cursor returns to the menu item name, and the setting value reverts to the previous condition.

[System/Current Time] screen

- Press the MENU key to return to the [SYSTEM] menu screen.

Selecting the language

- At the [SYSTEM] menu screen, select [Language] and press the ENT key.
- A popup list appears. Use the \triangle / ∇ keys to select the language and press the ENT key.



[SYSTEM] menu screen

Using the shoulder belt

The supplied shoulder belt can be used to support the unit during a measurement.

1. Attach the belt to the bar on the top section of the unit.
2. Wear the belt around your neck, as shown in the illustration.

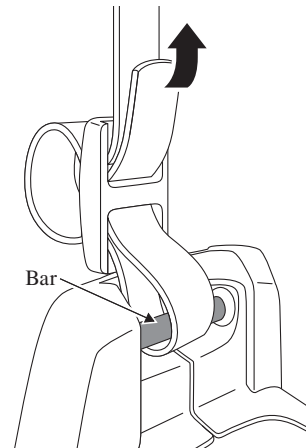

⚠ WARNING

When making measurements on exposed rotating parts or power train parts of machinery, do not use the shoulder belt to prevent the possibility of the belt getting caught in the machine.

Attaching the sensor to the protective cover

When transporting the unit, the sensor can be housed in the cradle on the protective cover of the unit, as shown in the illustration at right.

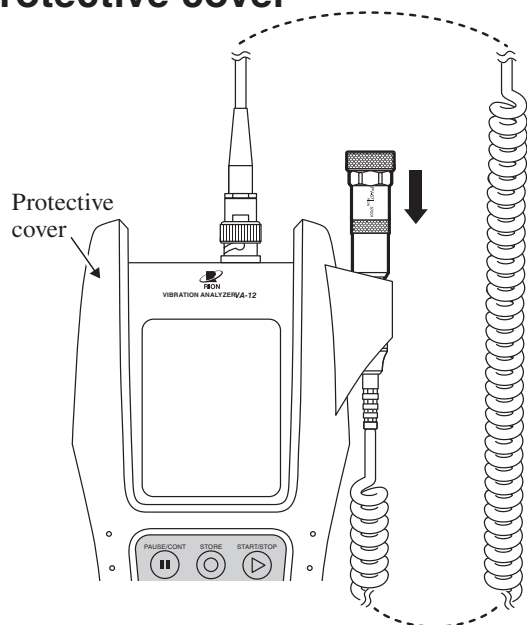

Note

The protective cover serves to protect the unit from external shocks. We recommend leaving the cover on during use.

⚠ Caution

Dropping the sensor or otherwise subjecting it to shocks can lead to damage. If the unit is carried upside down with the sensor in the protective cover (with the INPUT connector for the accelerometer pointing down), the sensor may fall out. Take care to avoid this.

Connection to a printer (BL-112UI)

The USB port on the bottom can be used to connect the VA-12 to a printer, as shown below. The USB Mini B - B cable CC-97 is available as an option.

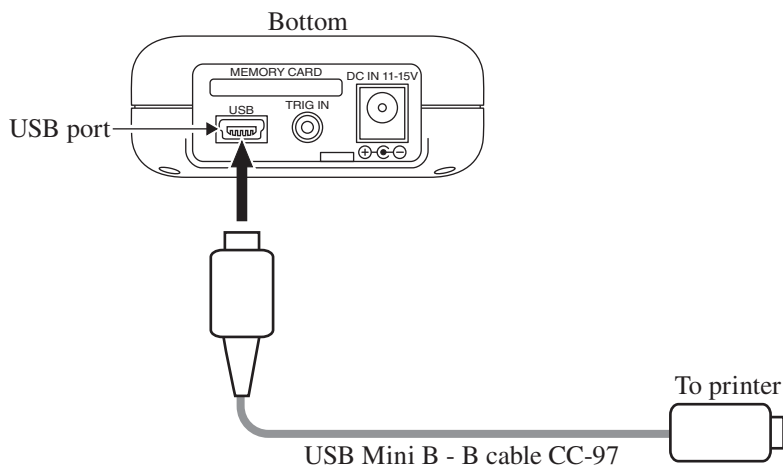

Menu Operation

Menu structure

The menus of the VA-12 are organized in a hierarchical structure. To return to the next higher level from a lower level, press the MENU key.

Bold: Screen name, Regular font: Item name

*: Can also be selected in recall mode

Higher ←	→ Lower	Available settings
Menu List		
└─	System (Language)	
└─┬─	Backlight Brightness Dark / Bright
└─┬─	Backlight Auto-Off 30s / 3min / Cont.
└─┬─	Read/Save Setting	
└─┬─┬─	Setting	
└─┬─┬─┬─	SYSTEM/Setting	
└─┬─┬─┬─	SD read	
└─┬─	Time Setting	
└─┬─┬─	Current Time	
└─┬─	Beep OFF / ON
└─┬─	System-Program Information	
└─┬─┬─	Program Information	
└─┬─	Language 日本語 / English
└─┬─	SD Card Format Off / Exec / Full
└─	Measurement *	
└─┬─	Store Name MAN_0000 to MAN_9999
└─┬─	Trigger Mode Free / Repeat / Single / Time
└─┬─	Wave Record OFF / ON
└─┬─	Trigger source Level / External
└─┬─	Pre-Trigger OFF / ON
└─┬─	Trigger Level -7/8 to 7/8
└─┬─	Slope - / +
└─┬─	Trigger Start Time 00:00 to 23:59
└─┬─	Store Interval 1min / 5min / 10min / 30min / 60min
└─┬─	Store number 0001 to 1000
└─	Display *	
└─┬─	VM Scale * Log / Linear
└─┬─	FFT Scale * Log / Linear
└─┬─	X unit * Hz / kcpm / odr
└─┬─	Standard Frequency 0.03125 Hz to 20.00000 kHz
└─┬─	Y unit * Log / Linear
└─┬─	Level List Off / On
└─┬─	Time Level Off / On
└─┬─	Overlapping Off / On / Clear
└─	Analog Input *	
└─┬─	High-pass Filter 1 Hz / 3 Hz / 10 Hz / 1 kHz
└─┬─	Low-pass Filter 1 kHz / 5 kHz / 20 kHz
└─┬─	Sensor Selection PV-571 / Other
└─┬─	Sensitivity PV-571: 100 × 0.01 mV/ms ⁻² to 999 × 0.01 mV/ms ⁻² Other: 100 × 0.001 mV/ms ⁻² to 999 × 0.1 mV/ms ⁻²
└─	FFT *	
└─┬─	Window Func. Rectangular / Hanning / Flat top
└─┬─	Operation Type LIN / EXP / MAX
└─┬─	Average number 0001 to 2048
└─	Print *	
└─┬─	Save to SD*	
└─┬─	Print *	
└─┬─	Cancel *	
└─	Recall	

Menu flow diagram

A diagram of the overall menu structure is shown below.

You first access the menu list and then proceed to the desired menu page.

To directly return to the measurement screen, press the START/STOP key.

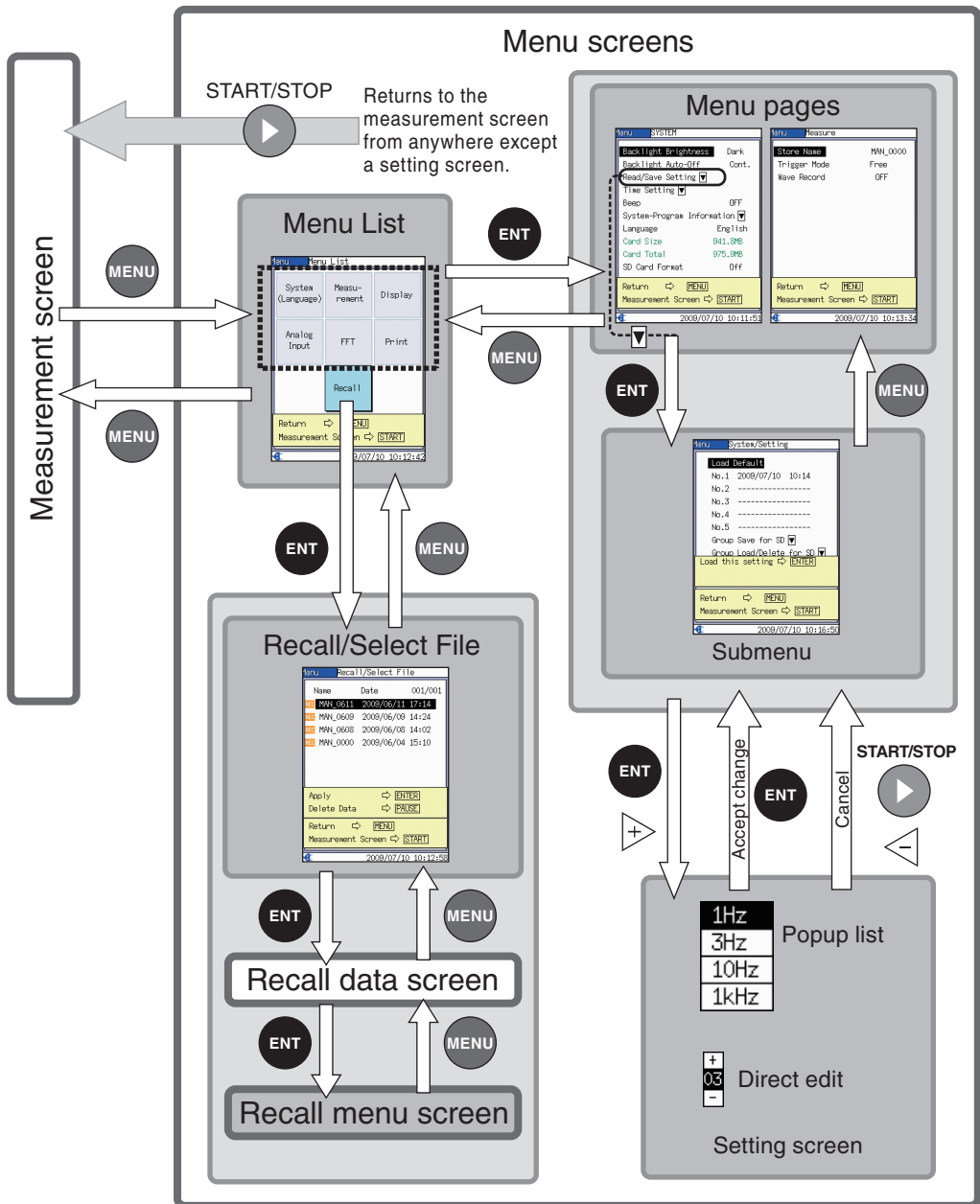

Menu operation

Calling up a menu page

1. Press the MENU key to bring up the [Menu List] screen.
2. Use the \triangle / ∇ / \triangleleft / \triangleright keys to select the desired menu name ([FFT] in the example) and press the ENT key.

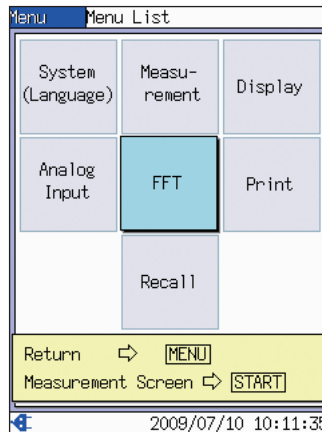

[Menu List] screen

Note

The cursor will continue to move through the menu names also when the left/right/top/bottom boundary is reached. For example, when you press the \triangleright key while the cursor is on [Print], the highlight moves to [Analog Input]. When you press the \triangleleft key in this condition, the highlight moves back to [Print]. This allows you to quickly bring the cursor to any desired item.

3. The [FFT] menu screen appears.

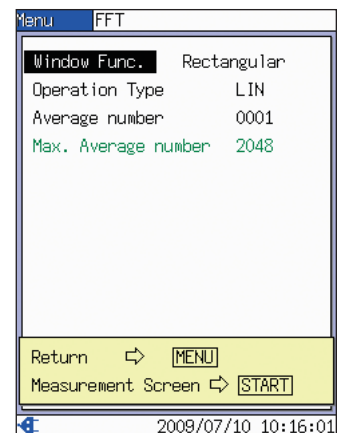

[FFT] menu screen

Calling up a submenu

Menu items for which a ▾ symbol is shown at right have a submenu screen.

1. Use the ▲ / ▼ keys to move the cursor to the menu item for which to display the submenu ([Read/Save Setting] in the example).

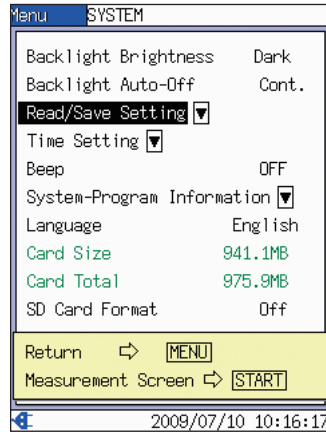

[SYSTEM] menu screen

Note

The cursor will continue to move through the menu items also when the top/bottom boundary is reached. For example, when you press the ▲ key while the cursor is on [Backlight Brightness] on the [SYSTEM] menu screen, the highlight moves to [SD Card Format]. When you press the ▼ key in this condition, the highlight moves back to [Backlight Brightness]. This allows you to quickly bring the cursor to any desired item.

2. Press the ENT key. The [System/Setting] screen appears.

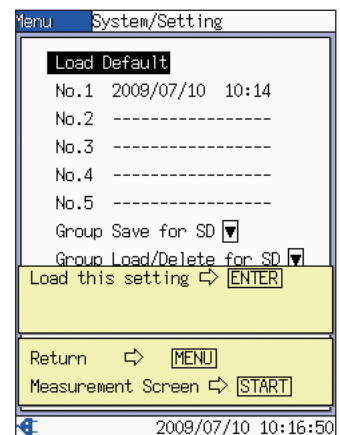

[System/Setting] screen

Making settings from a popup list

1. Use the \triangle / ∇ keys to move the cursor to the menu item to set ([High-pass Filter] in the example).
2. Press the ENT key or the \blacktriangleright key. A popup list appears.

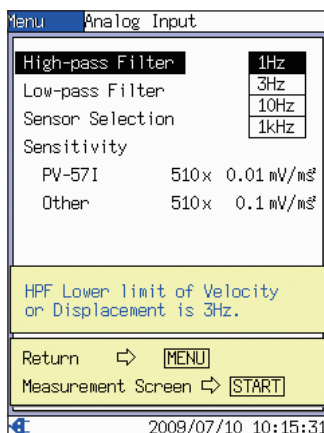

[Analog Input] menu screen

3. Use the \triangle / ∇ keys to make your selection.
Press the ENT key to accept the setting.
To cancel, press the START/STOP key or the \triangleleft key.

Note

The cursor will continue to move through the items in the popup list also when the top/bottom boundary is reached. For example, when you press the \triangle key while the cursor is on [1Hz], the highlight moves to [1kHz]. When you press the ∇ key in this condition, the highlight moves back to [1Hz]. This allows you to quickly bring the cursor to any desired item.

Making a setting by direct edit

Numeric values such as date and time or sensor sensitivity can be set by directly editing the setting.

1. Use the \triangle / ∇ keys to move the cursor to the menu item to set ([Other] in the example).
2. Press the ENT key or the \triangleright key. The value can now be edited, two digits at a time, as shown below.

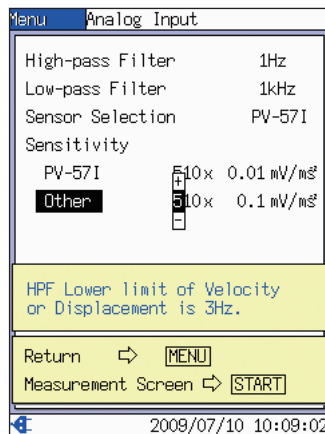

Use the \triangleleft / \triangleright keys to move to the item to change, and use the \triangle / ∇ keys to change the numeric value.

Holding down the \triangle / ∇ keys changes the value more quickly.

When the correct value has been set, press the ENT key to accept the setting.

To cancel the procedure without changing the current setting, press the START/STOP key or the \triangleleft key. The cursor returns to the menu item name, and the setting value reverts to the previous condition.

[Analog Input] menu screen

3. When the value has been set, the cursor automatically moves to the next two digits, and these can be edited.

Analysis Functions

Available analysis types

The VA-12 has three analysis functions: “vibration meter mode”, “time waveform mode”, and “FFT mode”. These can be chosen as required by the application.

Vibration meter mode

Select this mode to use the VA-12 as a vibration meter.

Time waveform mode

Select this mode to use the VA-12 for checking time waveforms.

FFT mode

Select this mode to perform FFT analysis. You can choose between graph display and list display (see next page).

Note
In the default condition, only the vibration meter mode and FFT mode (graph display) can be called up on the display. To view other modes, use the [Display] menu and make the appropriate settings (see page 30).

Switching between analysis functions

Each push of the VM/TIME/FFT key cycles the unit through the following settings: vibration meter mode → time waveform mode → FFT mode (graph display) → FFT mode (list display) → vibration meter mode → ... (solid arrows in the illustration below)

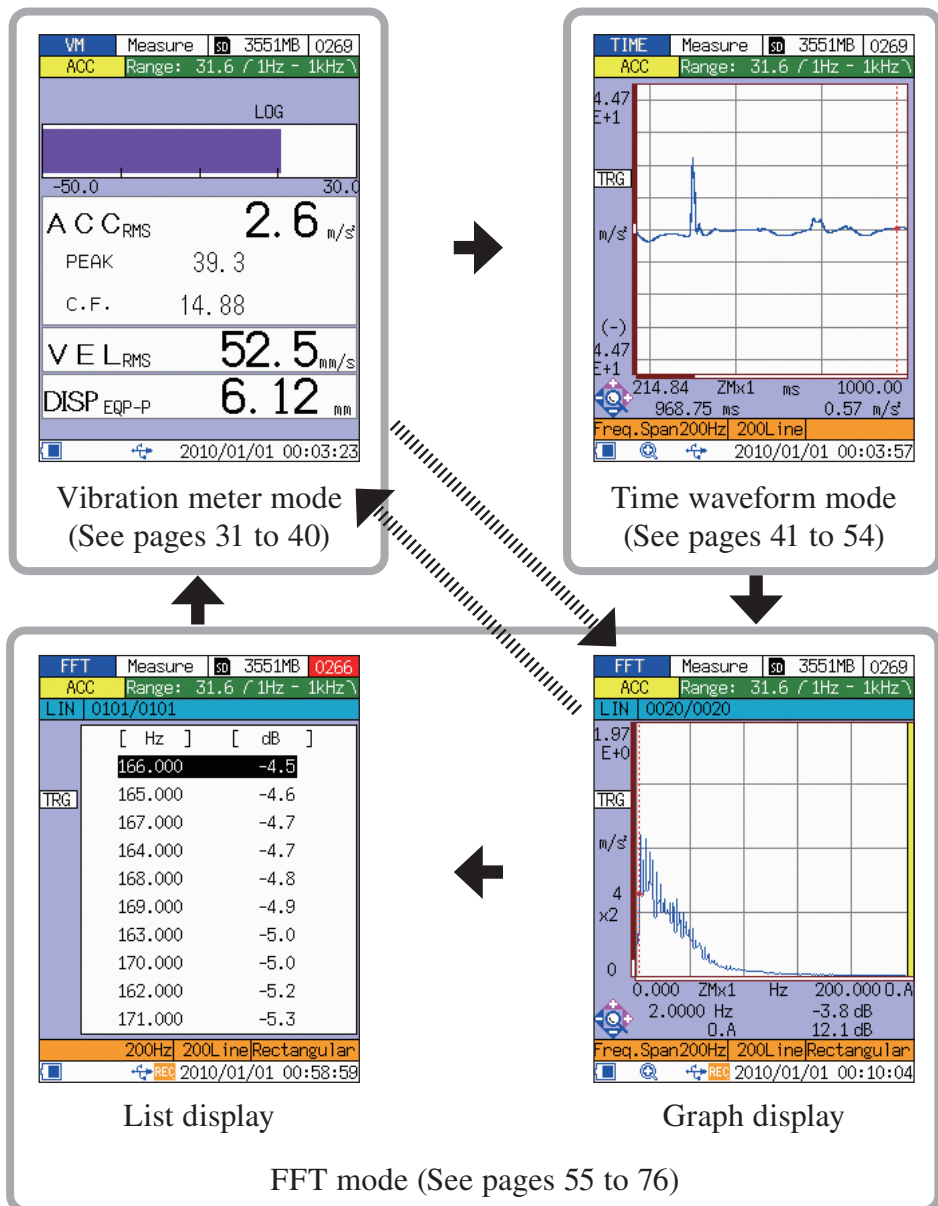

Because the time waveform mode and FFT mode (list display) are not shown in the default condition, the VM/TIME/FFT key operates as indicated by the broken arrows in the above illustration.

To access the time waveform mode and FFT mode (list display), proceed as follows.

- To display the time waveform mode
Call up the [Display] menu and set [Time Level] to [On].
- To display the FFT mode (list display)
Call up the [Display] menu and set [Level List] to [On].

Note
<p>The action of the VM/TIME/FFT key may differ, depending on the operation status of the unit. In vibration meter mode and time waveform mode, the key is disabled while the measurement is paused and during trigger operation. For information on key action in FFT mode, see page 64.</p>

Measurement in Vibration Meter Mode

Before starting a measurement, be sure to set the clock of the unit to the correct date/time (see pages 18 to 19).

This section contains the minimum instructions for measurement in vibration meter mode. The following items are explained.

- Reading the displayPages 32 to 36
- Changing measurement parameters
and display parametersPages 37 to 38
- Performing measurement..... Page 39
- Storing measurement data Page 40

For information on other items related to vibration meter mode measurement, refer to the following sections.

- Trigger Functions Pages 91 to 109
- Saving the Screen as a BMP FilePages 85 to 86
- Printing the screen.....Pages 87 to 88
- Folder structure of stored data Page 126

Reading the display

Measurement parameter items

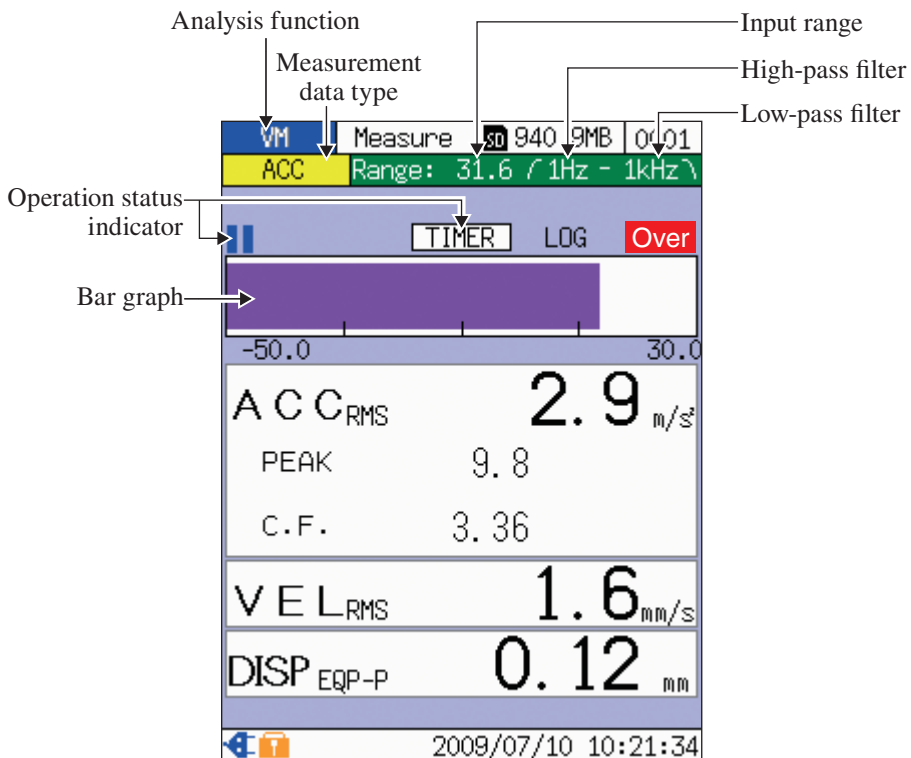

Analysis function

Shows “VM”. The function can be switched with the VM/TIME/FFT key.

Measurement data type

Shows “ACC” (Acceleration), “VEL” (Velocity), or “DISP” (Displacement). This can be switched with the ACC/VEL/DISP key.

Input range

Shows the currently selected input range. The setting can be changed with the RANGE \triangle / ∇ keys.

Available settings depend on the sensor sensitivity and the measurement data type. For details, see the “Specifications” section on page 153.

High-pass filter

The high-pass filter value set from the [Analog Input] menu screen is shown here.

The following settings are available:

1 Hz, 3 Hz, 10 Hz, 1 kHz

Low-pass filter

The low-pass filter value set from the [Analog Input] menu screen is shown here.

The following settings are available:

1 kHz, 5 kHz, 20 kHz

Bar graph

The currently selected measurement data are also shown as a bar graph.

The displayed data can be switched with the ACC/VEL/DISP key.

Note
While the measurement is paused (see page 39) and during time trigger operation (see page 104), the measurement parameters cannot be changed.

Operation status indicator

- If the time trigger is enabled, **TIMER** is shown here.
The time trigger settings are made from the [Measure] menu screen. For details, see the “Trigger Functions” section.
- During time trigger standby, the **■** symbol flashes.
- During measurement pause (PAUSE/CONT key pressed), the **■■** symbol is shown.

Note
In the time trigger standby condition, the unit cannot be set to pause. Therefore the ■ and ■■ symbols will not appear together.

Display parameter items

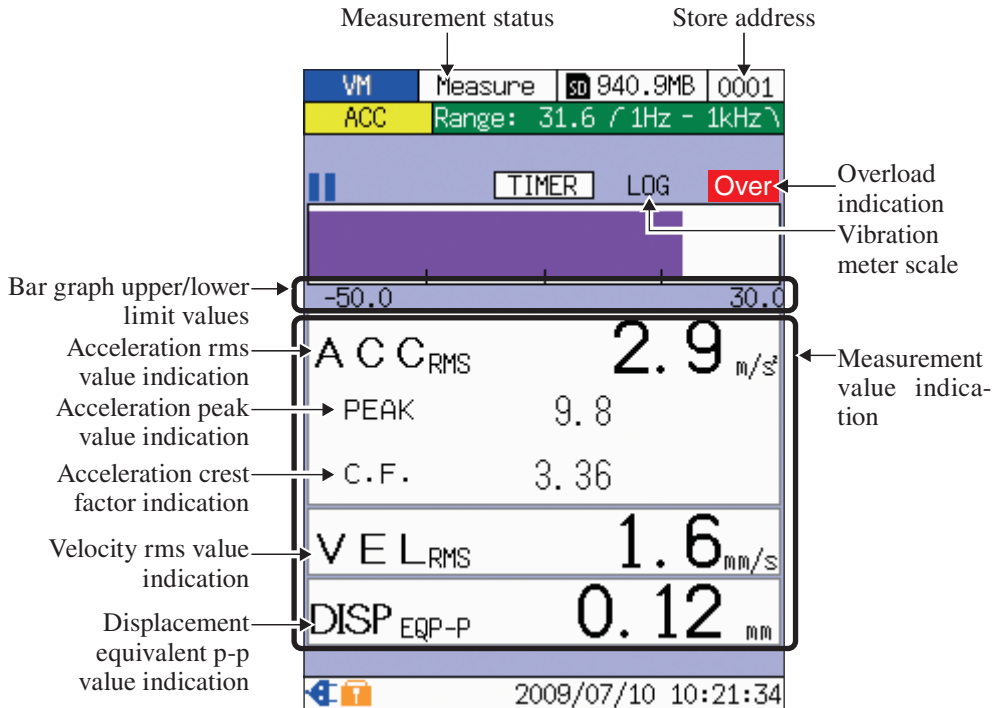

Measurement status

Shows “Measure”.

Store address

Shows the address that will next be used when storing data on the SD card. This can be changed with the Δ / ∇ keys, but if an address is selected which already contains data, the indication is highlighted in red, to alert the user that the data will be overwritten.

Overload indication

This indication appears when momentary overload has occurred. The indication goes out 1 second after the overload condition has been cleared.

Vibration meter scale

The indication shows “LOG” if the selected bar graph scale is logarithmic, or “LIN” if the scale is linear.

The setting can be switched using the [VM Scale] item in the [Display] menu.

Measurement value indication

Five measurement values are shown simultaneously and are updated every second.

When momentary overload has occurred, the respective measurement value indication is highlighted in red.

Displacement equivalent p-p value indication

The equivalent p-p value for displacement ($\text{rms value} \times 2\sqrt{2}$) is shown here as a numeric indication.

Velocity rms value indication

The rms value for velocity is shown here as a numeric indication.

Acceleration crest factor indication

The acceleration crest factor (peak value / rms value) is shown here as a numeric indication.

Acceleration peak value indication

The acceleration peak value (single amplitude maximum value) is shown here as a numeric indication.

Acceleration rms value indication

The acceleration rms value (square root of the arithmetic mean of the square's set of instantaneous values) is shown here as a numeric indication.

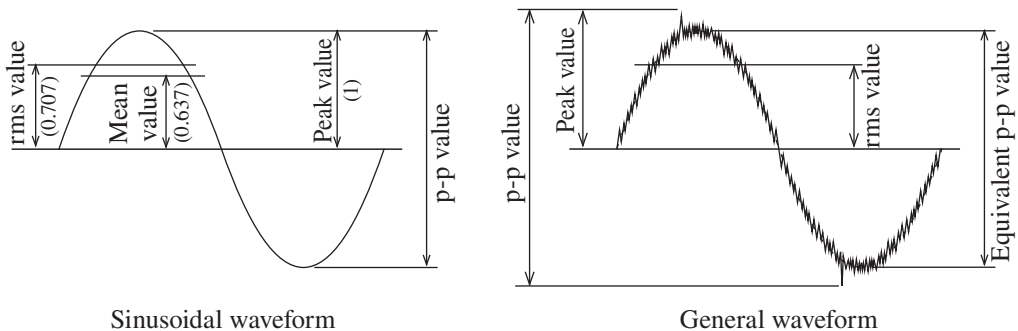

In the case of a sinusoidal waveform, the peak value is the rms value $\times \sqrt{2}$. However, this does not apply to a general waveform.

How measurement values are defined

Bar graph upper/lower limit values

The right-side indication shows the upper limit value and the left-side indication shows the lower limit value.

The values depend on the measurement data type, input range, and vibration meter scale.

Other items

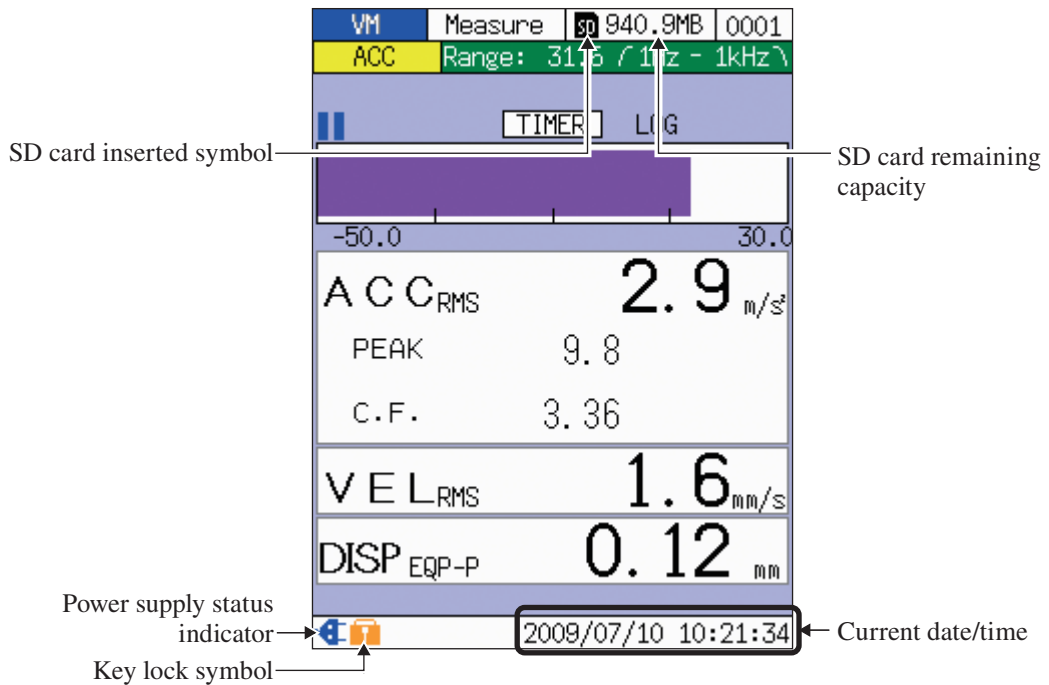

SD card remaining capacity

When an SD card is inserted, the remaining capacity is shown here.

Current date/time



The current date and time are shown here.

For information on how to set the date and time, see the “Preparations” section on pages 18 to 19.

Key lock symbol

Pressing the VM/TIME/FFT key for 2 seconds while holding down the MENU key sets the unit to the key lock condition where all operation keys are disabled, and this symbol  is shown. To cancel the condition, repeat the procedure.

Power supply status indicator

During battery-powered operation, the battery capacity symbol  is shown here. When the unit is powered from an external source, the AC power symbol  is shown here. For details, see the “Power Supply” section on page 120.

SD card inserted symbol

Appears when an SD card is inserted into the unit.

Changing measurement parameters and display parameters

The measurement parameters and display parameters in vibration meter mode are as follows.

		Menu	Key operation	See page
Measurement parameter	Sensor information	Analog Input	—	16, 38
	High-pass filter	Analog Input	—	33
	Low-pass filter	Analog Input	—	33
	Input range	—	RANGE \triangle / ∇	38
	Trigger operation settings	Measure	—	95
	Store name	Measure	—	38
	Measurement data type (data shown as a bar graph)	—	ACC/VEL/DISP	32
Display parameter	Vibration meter scale	Display	—	38

For information on menu structure and menu operation, see the “Menu Operation” section.

Restriction for changing measurement parameters

In the following cases, measurement parameters cannot be changed.

- During measurement pause (■ symbol shown on the left side of the display)
- During time trigger operation

Making sensor settings

Use the supplied calibration chart of the accelerometer you intend to use, and make the sensitivity setting by performing the following steps.

1. From the [Analog Input] menu screen, select [Sensor Selection] and then [PV-57I] or [Other].
2. Set [Sensitivity] to the sensitivity value given on the calibration chart.

Note
When selecting [PV-57I], a popup window appears, asking whether you want to change the sensitivity setting. Also, note that the factor cannot be changed.

Changing the input range

Set the input range to an optimum setting.

If overload occurs (measurement value display background is red, and **Over** indication appears on the right side of the display), the input range setting is too low. Use the RANGE \triangle key to increase the setting.

Specifying the store name

To store measurement data, it is necessary to first specify a store name. Access the [Measure] menu and select [Store Name].

Measurement data will be stored in a folder of the specified name. (See the “SD Card” section.)

Selecting the vibration meter scale

1. From the [Display] menu screen, select [VM Scale].
2. Select one of the following.
 - Log: Logarithmic scale
 - Linear: Linear scale

Performing measurement

The measurement will start automatically when the vibration meter mode measurement screen is brought up. The following values are measured simultaneously and updated in 1-second intervals.

- Acceleration rms value (m/s^2)
- Acceleration peak value (m/s^2)
- Acceleration crest factor
- Velocity rms value (mm/s)
- Displacement equivalent p-p value (mm)

For information on how to use the time trigger function to save data, see the “Trigger Functions” section.

Pausing the measurement

To pause the measurement, press the PAUSE/CONT key.

During a pause, the ■■ symbol is shown on the left side of the display.

To resume the measurement, press the PAUSE/CONT key once more.

Note
In the pause condition (■■ symbol shown on the left side of the display), the measurement parameters cannot be changed.

Storing measurement data

You can store measurement data on an SD card inserted in the unit.

When using the time trigger function to store data, refer to the “Trigger Functions” section.

1. Verify that the SD card symbol  is shown on the title bar.
If no symbol is shown, insert an SD card.
2. Check the store address shown at the right end of the title bar.
 - If the address is shown on a white background:
Proceed to step 3.
 - If the address is shown on a red background:
This indicates that the store address already contains measurement data. If the data can be overwritten, proceed to step 3.
If you do not want to overwrite the data, use the \triangle / ∇ keys to select a different store address that is shown on a white background.
3. Press the STORE key.
The popup indication “STORE XXXX” (where XXXX is the store address) appears, storing is carried out, and the LED indicator flashes in red.
When storing is complete, the store address is incremented by one.
If the store address was 1000, the indication returns to 0001.

For information on how to view stored data, refer to the “Recalling Stored Data” section. For information on the folder structure of stored data, refer to the “SD Card” section.

Measurement in Time Waveform Mode

Before starting a measurement, be sure to set the clock of the unit to the correct date/time (see pages 18 to 19).

This section contains basic instructions for measurement in time waveform mode. The following items are explained.

- Reading the displayPages 42 to 47
- Changing measurement parametersPages 48 to 50
- Zooming/moving the displayPages 51 to 53
- Performing measurement..... Page 53
- Storing measurement data Page 54

For information on other items related to time waveform mode measurement, refer to the following sections.

- Trigger FunctionsPages 91 to 109
- Saving the Screen as a BMP FilePages 85 to 86
- Printing the screen.....Pages 87 to 88
- Folder structure of stored data Page 126

Reading the display

Measurement parameter items

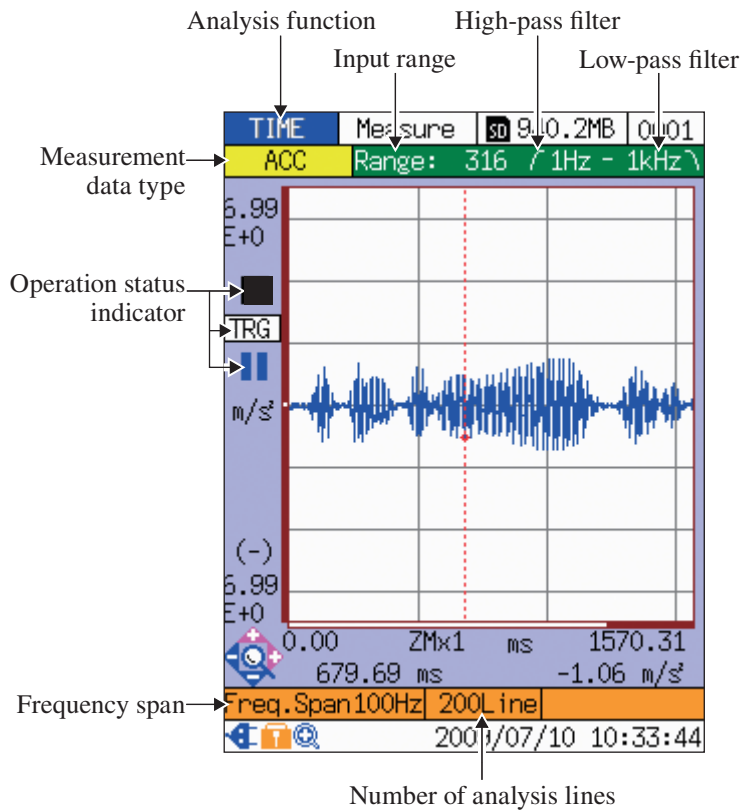

Analysis function

Shows “TIME”. The function can be switched with the VM/TIME/FFT key.

Input range

Shows the currently selected input range. The setting can be changed with the RANGE Δ / ∇ keys.

Available settings depend on the sensor sensitivity and the measurement data type. For details, see the “Specifications” section on page 153.

High-pass filter

The high-pass filter value set from the [Analog Input] menu screen is shown here.

The following settings are available:

1 Hz, 3 Hz, 10 Hz, 1 kHz

Low-pass filter

The low-pass filter value set from the [Analog Input] menu screen is shown here.

The following settings are available:

1 kHz, 5 kHz, 20 kHz

Number of analysis lines

Shows the setting made with the LINE key.

The following settings are available.

200, 400, 800, 1600, 3200

Frequency span

Indicates the currently selected maximum frequency that can be measured.

The following settings are available.

100 Hz, 200 Hz, 500 Hz, 1 kHz, 2 kHz, 5 kHz, 10 kHz, 20 kHz

Pressing the **FREQ SPAN** key brings up a popup list.

Then use the \triangle / ∇ keys to make the selection.

Operation status indicator

- If the repeat trigger or single trigger is enabled, **TRG** is shown here. If the time trigger is enabled, **TIME** is shown.
The trigger settings are made from the [Measure] menu screen. For details, see the “Trigger Functions” section.
- During trigger standby, the **■** symbol flashes.
- While measurement or trigger operation is paused (PAUSE/CONT key pressed), the **■■** symbol is shown.
- If momentary overload has occurred, the **Over** indication is shown. The indication goes out 1 second after the overload condition has been cleared.

Measurement data type

Shows “ACC” (Acceleration), “VEL” (Velocity), “DISP” (Displacement), or “ACCe” (Envelope). This can be switched with the ACC/VEL/DISP key.

Note
While the measurement is paused and during the trigger operation (see page 97), the measurement parameters cannot be changed.

Display parameter items

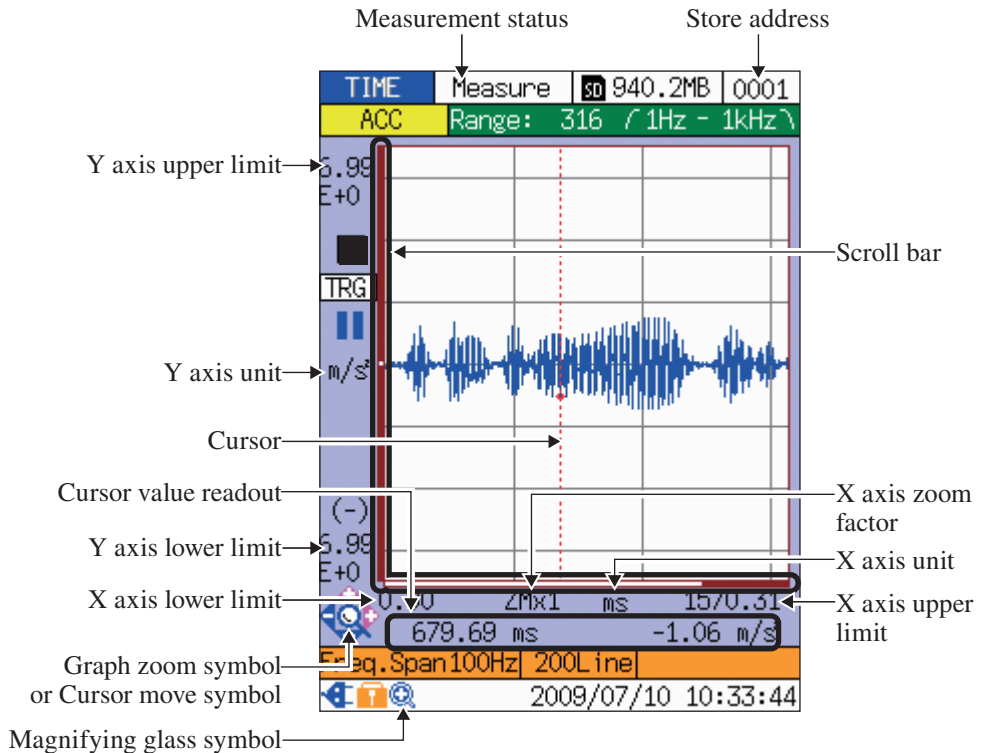

Measurement status

Shows “Measure”.

Store address

Shows the address that will next be used when storing data on the SD card. This can be changed with the Δ / ∇ keys, but if an address is selected which already contains data, the indication is highlighted in red, to alert the user that the data will be overwritten.

Scroll bar

The portion of the overall data that are currently displayed on the screen is indicated by a white line. Cursor movement and zoom actions will result in a change in the length of the white line.

For details, see page 52.

X axis zoom factor

Shows the X axis zoom factor for the currently displayed graph. The following settings are available.

- Number of analysis lines is 3200: ×1, ×2, ×4, ×8, ×16, ×32
- Number of analysis lines is 1600: ×1, ×2, ×4, ×8, ×16
- Number of analysis lines is 800: ×1, ×2, ×4, ×8
- Number of analysis lines is 400: ×1, ×2, ×4
- Number of analysis lines is 200: ×1, ×2

X axis unit

Shows “ms”.



X axis upper limit



Shows the upper limit value of the X axis for the current display range.

Magnifying glass symbol

This appears in display scaling mode. The SCALE ON/OFF key is used to switch the mode on and off. For details, see page 51.

Graph zoom symbol or cursor move symbol

These appear in display scaling mode (see page 51) and show the function of the $\leftarrow/\rightarrow/\triangle/\nabla$ keys. When the graph zoom symbol  is shown, the $\leftarrow/\rightarrow/\triangle/\nabla$ keys serve to change the zoom factor. When the cursor move symbol  is shown, the \leftarrow/\rightarrow keys serve to move the cursor.

The SCALE EXPAND/MOVE key is used to switch between the graph zoom symbol  and the cursor move symbol .

X axis lower limit

Shows the lower limit value of the X axis for the current display range.



Y axis lower limit

Shows the lower limit value of the Y axis for the current display range.

Cursor value readout

This shows the value at the marker symbol  on the cursor. The left value is for the X axis and the right value for the Y axis.

Cursor

The cursor can be moved right and left with the / keys. Holding down a key will move the cursor faster. If the cursor is shown as a broken line, it cannot be moved (see page 52).

Y axis unit

The unit indication changes according to the measurement data type.

- Acceleration: m/s^2
- Velocity: mm/s
- Displacement: mm
- Envelope: No indication

Y axis upper limit

Shows the upper limit value of the Y axis for the current display range.

Other items

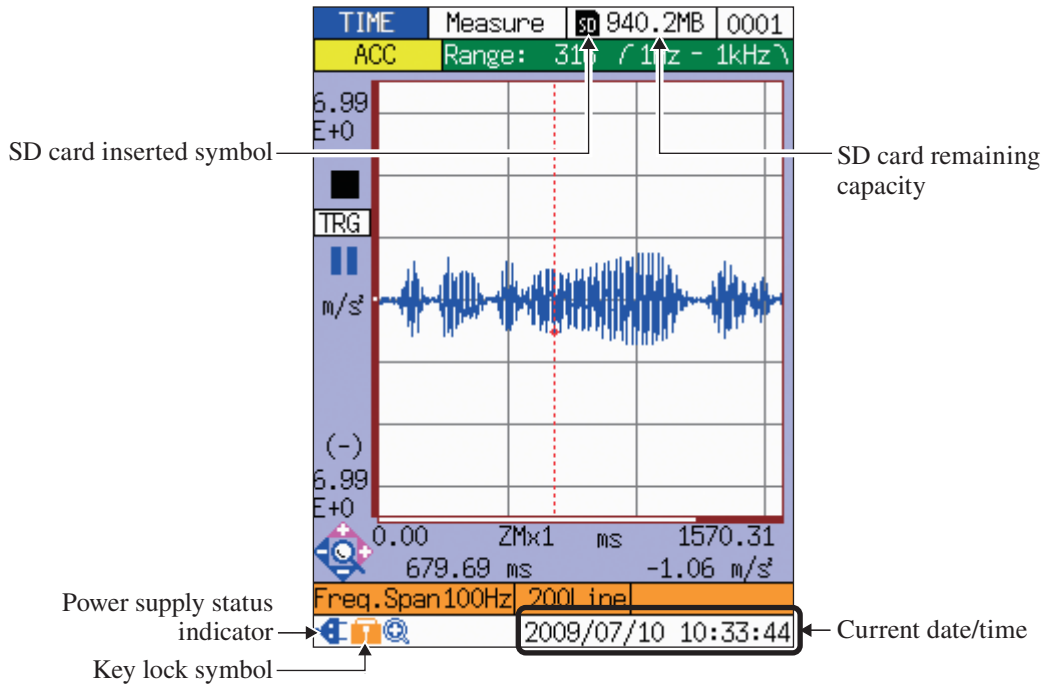

SD card remaining capacity

When an SD card is inserted, the remaining capacity is shown here.

Current date/time



The current date and time are shown here.

For information on how to set the date and time, see the “Preparations” section on pages 18 to 19.

Key lock symbol

Pressing the VM/TIME/FFT key for 2 seconds while holding down the MENU key sets the unit to the key lock condition where all operation keys are disabled, and this symbol  is shown. To cancel the condition, repeat the procedure.

Power supply status indicator

During battery-powered operation, the battery capacity symbol  is shown here. When the unit is powered from an external source, the AC power symbol  is shown here. For details, see the “Power Supply” section on page 120.

SD card inserted symbol

Appears when an SD card is inserted into the unit.

Changing measurement parameters

The measurement parameters in time waveform mode are as follows.

		Menu	Key operation	See page
Measurement parameter	Sensor information	Analog Input	—	16, 49
	High-pass filter	Analog Input	—	42
	Low-pass filter	Analog Input	—	43
	Measurement data type	—	ACC/VEL/DISP	43
	Input range	—	RANGE \triangle / ∇	49
	Frequency span	—	FREQ SPAN	43
	Number of analysis lines	—	LINE	43
	Trigger operation settings	Measure	—	93 to 96
	Store name	Measure	—	50

For information on menu structure and menu operation, see the “Menu Operation” section.

Restriction for changing measurement parameters

In the following cases, measurement parameters cannot be changed.

- During measurement pause (■ symbol shown on the left side of the display)
- During trigger operation

Making sensor settings

Use the supplied calibration chart of the accelerometer you intend to use, and make the sensitivity setting by performing the following steps.

1. From the [Analog Input] menu screen, select [Sensor Selection] and then [PV-57I] or [Other].
2. Set [Sensitivity] to the sensitivity value given on the calibration chart.

Note

When selecting [PV-57I], a popup window appears, asking whether you want to change the sensitivity setting. Also, note that the factor cannot be changed.

Changing the input range

Set the input range to an optimum setting (see middle illustration below).

If the **Over** indication appears on the left side of the display, the input range setting is too low. Use the RANGE Δ key to increase the setting (see left illustration below).

If the graph amplitude is too small, the input range setting is too high. Use the RANGE ∇ key to decrease the setting (see right illustration below).

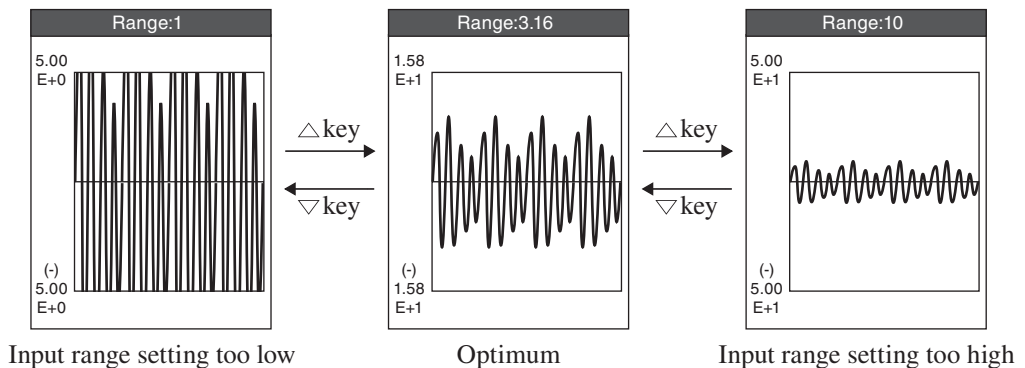

Relation between RANGE Δ / ∇ keys and display

Specifying the store name



To store measurement data, it is necessary to first specify a store name. Access the [Measure] menu and select [Store Name].

Measurement data will be stored in a folder of the specified name. (See the “SD Card” section.)

Zooming/moving the display

To expand or shrink the display, proceed as follows.

1. Enable the display scaling/zoom mode (graph zoom symbol  shown at the bottom left of graph) (see illustration below).

If the magnifying glass symbol  is shown, the unit is in display scaling mode. Press the SCALE EXPAND/MOVE key as required. If the magnifying glass symbol  is not shown, first press the SCALE ON/OFF key to switch the unit to display scaling mode. Then press the SCALE EXPAND/MOVE key as required.

2. To zoom along the X axis, use the \leftarrow / \rightarrow keys.



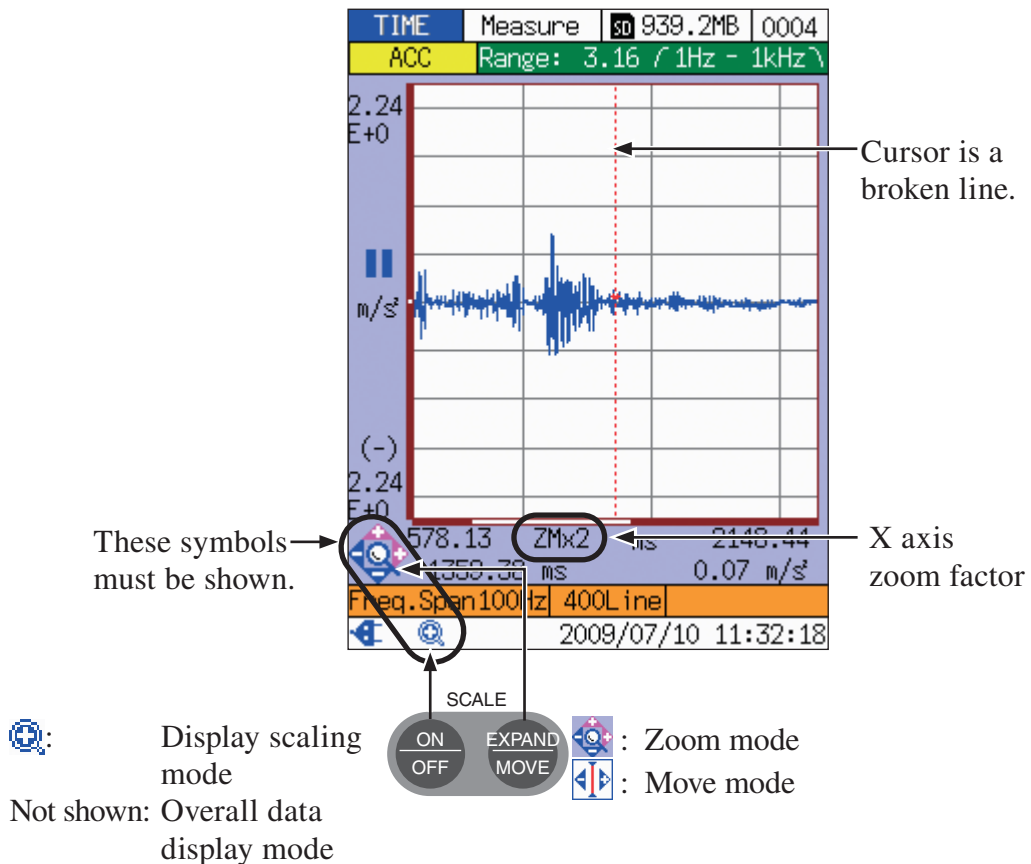

The zoom factor is shown at the bottom of the graph.

To zoom along the Y axis, use the \triangle / ∇ keys.

The zoom factor is not indicated.



Functions of ◀ / ▶ / ▲ / ▼ keys differ, according to display mode

Display mode	Symbol		Cursor	Key operation			
				◀	▶	▲	▼
Overall data display	None		Solid line	Move cursor left *	Move cursor right *	Increment store address (+)	Decrement store address (-)
Display scaling/zoom			Broken line	Shrink X axis	Expand X axis	Expand Y axis	Shrink Y axis
Display scaling/move			Solid line	Move cursor left *	Move cursor right *	Increment store address (+)	Decrement store address (-)

* When the cursor is near the display edge, the cursor does not move but the display is scrolled. When the edge is reached, the cursor moves to the other edge. When the X axis display range is not 100%, the screen also scrolls to the other edge.

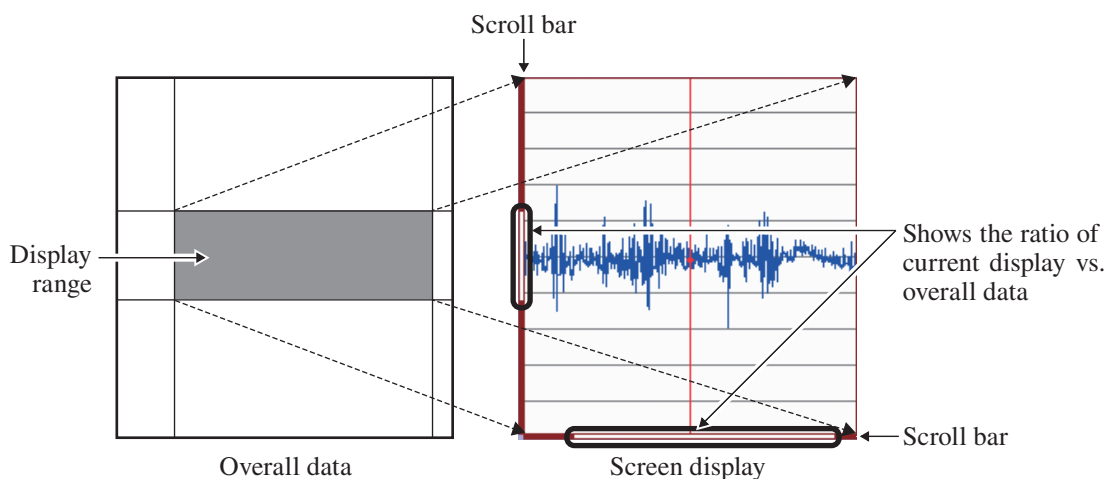

Relation between overall data and display range

In display scaling mode, scroll bars are shown to indicate which section of the overall data is currently shown on the display.



X axis zoom factor

The X axis display range when the unit is in overall data display mode, and when the unit is in display scaling mode and the X axis zoom factor has been set to 1 will be different.

- Overall data display mode (no magnifying glass symbol  the shown on the status bar)
Overall data (number of analysis lines × 2.56) are shown.
- Display scaling mode (magnifying glass symbol  shown on the status bar), X axis zoom factor set to 1
Overall data are shown partially (depending on number of analysis lines).

Y axis zoom factor

In time waveform mode, the Y axis zoom factor is not shown. The zoom factor can be calculated according to the following equation.

$$\text{Y axis zoom factor} = \text{input range} / \text{Y axis upper limit}$$

Note
The Y axis zoom factor is 2^n ($n = 0$ to 14), but because the number of digits in the displayed input range and the Y axis upper limit is small, the factor may be a fractional number.

Performing measurement

The screen in time waveform mode shows the fluctuation in the measurement data (acceleration, velocity, displacement, or acceleration envelope curve) in a graphical format. The display is updated constantly.

The measurement duration that can be displayed on screen is determined as follows: number of analysis lines/frequency span. (See the “Frequency resolution (Δf) and frame time (T_{Frame})” section on page 72.) In time waveform mode, the measurement duration is the same as the “frame time” in FFT mode.

Note
In FFT mode, it is possible to continuously record time waveform data for longer than the measurement duration available in time waveform mode. For details, see the “Recording Waveform Data” section on page 77.

For information on measurement using the trigger functions of the unit, see the “Trigger Functions” section.



Storing measurement data

You can store measurement data on an SD card inserted in the unit.

When the trigger function is enabled, refer to the “Trigger Functions” section.

1. Verify that the SD card symbol  is shown on the title bar.
If no symbol is shown, insert an SD card.
2. Check the store address shown at the right end of the title bar.
 - If the address is shown on a white background:
Proceed to step 3.
 - If the address is shown on a red background:
This indicates that the store address already contains measurement data. If the data can be overwritten, proceed to step 3.
If you do not want to overwrite the data, use the Δ / ∇ keys to select a different store address that is shown on a white background.

Note

If the graph zoom symbol  is shown at the bottom left of the graph, press the SCALE EXPAND/MOVE key or the SCALE ON/OFF key. Verify that the symbol is now  or that no symbol is shown, and then use the Δ / ∇ keys.

3. Press the STORE key.
4. The popup indication “STORE XXXX” (where XXXX is the store address) appears, storing is carried out, and the LED indicator flashes in red.
When storing is complete, the store address is incremented by one.
If the store address was 1000, the indication returns to 0001.

For information on how to view stored data, refer to the “Recalling Stored Data” section. For information on the folder structure of stored data, refer to the “SD Card” section.

Measurement in FFT Mode

Before starting a measurement, be sure to set the clock of the unit to the correct date/time (see pages 18 to 19).

This section contains basic instructions for measurement in FFT mode. The following items are explained.

- Reading the display Pages 56 to 64
- Changing measurement parameters
and display parametersPages 65 to 68
- Zooming/moving the displayPages 69 to 70
- Performing measurement.....Pages 71 to 74
- Storing measurement dataPages 75 to 76

For information on other items related to FFT mode measurement, refer to the following sections.

- Trigger Functions Pages 91 to 109
- Overlay DisplayPages 110 to 111
- Saving the Screen as a BMP FilePages 85 to 86
- Printing the screen.....Pages 87 to 88
- Folder structure of stored data Page 126

Reading the display

Graph display (measurement parameter items)

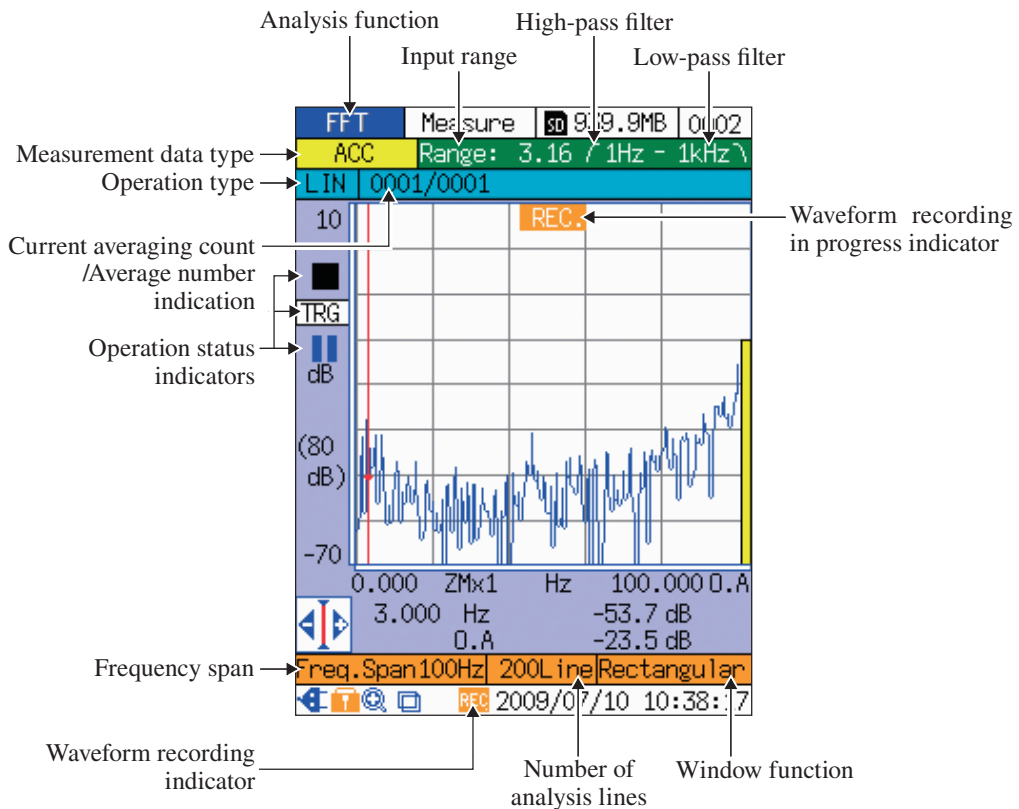

Analysis function

Shows “FFT”. The function can be switched with the VM/TIME/FFT key.

Input range

Shows the currently selected input range. The setting can be changed with the RANGE Δ / ∇ keys.

Available settings depend on the sensor sensitivity and the measurement data type. For details, see the “Specifications” section on page 153.

High-pass filter (left), Low-pass filter (right)

The high-pass filter and low-pass filter values set from the [Analog Input] menu screen are shown here.

The following settings are available:

High-pass filter: 1 Hz, 3 Hz, 10 Hz, 1 kHz

Low-pass filter: 1 kHz, 5 kHz, 20 kHz

Waveform recording in progress indicator

When the waveform recording function has been set to [ON], this indicator flashes during processing.

For details on the waveform recording function, see the “Recording Waveform Data” section. For details on the time trigger, see the “Trigger Functions” section.

Window function

Shows the time window setting made with [Window Func.] in the FFT menu.

- Rectangular: Rectangular window
- Hanning: Hanning window
- Flattop: Flat-top window

Number of analysis lines

Shows the setting made with the LINE key.

The following settings are available.

200, 400, 800, 1600, 3200

Waveform recording indicator

This is shown when the waveform recording function has been set to [On].

The setting is made with [Wave Record] in the [Measure] menu.

For details on the waveform recording function, see the “Recording Waveform Data” section.

Frequency span

Indicates the currently selected maximum frequency that can be measured.

The following settings are available.

100 Hz, 200 Hz, 500 Hz, 1 kHz, 2 kHz, 5 kHz, 10 kHz, 20 kHz

Pressing the **FREQ SPAN** key brings up a popup list.

Then use the \triangle / ∇ keys to make the selection.

Operation status indicator

- If the repeat trigger or single trigger is enabled, **TRG** is shown here. If the time trigger is enabled, **TIME** is shown.
The trigger settings are made from the [Measure] menu screen. For details, see the “Trigger Functions” section.
- During trigger standby, the **■** symbol flashes.
- During processing, the **▶** symbol flashes.
- While processing or trigger operation is paused (PAUSE/CONT key pressed), the **▬▬** symbol is shown.
- If momentary overload has occurred, the **Over** indication is shown.
The indication goes out 1 second after the overload condition has been cleared. During linear averaging, exponential averaging, or maximum hold, if momentary overload has occurred, the **Over** indication will remain on. However, the **Over** indication has priority.

Current averaging count/Average number indication

The “Average number” is the value set from the [FFT] menu. The “Current averaging count” shows how many averaging runs have been performed at the current point, when the operation type is linear averaging, exponential averaging, or maximum hold. When the operation type is instantaneous value, the Current averaging count/Average number is not displayed.

Operation type

- INST: Instantaneous value
- LIN: Linear average
- EXP: Exponential average
- MAX: Maximum hold

Pressing the INST/AVE key toggles between INST and the operation type set from the [FFT] menu.

Measurement data type

Shows “ACC” (Acceleration), “VEL” (Velocity), “DISP” (Displacement), or “ACCe” (Envelope). This can be switched with the ACC/VEL/DISP key.

Graph display (display parameter items)

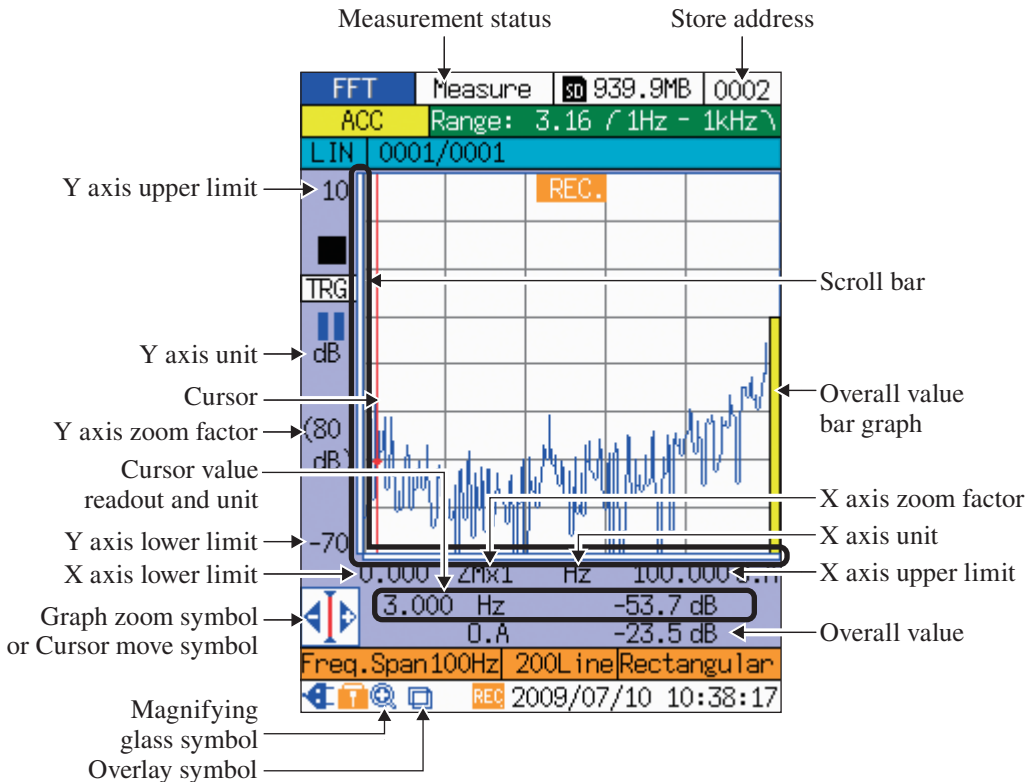

Measurement status

Shows "Measure".

Store address

Shows the address that will next be used when storing data on the SD card. This can be changed with the Δ / ∇ keys, but if an address is selected which already contains data, the indication is highlighted in red, to alert the user that the data will be overwritten.

Scroll bar

The portion of the overall data that are currently displayed on the screen is indicated by a white line. Cursor movement and zoom actions will result in a change in the length of the white line.

Overall value bar graph

Shows the overall value as a bar graph.

X axis zoom factor

Shows the X axis zoom factor for the currently displayed graph. The following settings are available.

- Number of analysis lines is 3200: ×1, ×2, ×4, ×8, ×16
- Number of analysis lines is 1600: ×1, ×2, ×4, ×8
- Number of analysis lines is 800: ×1, ×2, ×4
- Number of analysis lines is 400: ×1, ×2
- Number of analysis lines is 200: ×1

X axis unit

Shows the unit selected with [X Unit] in the [Display] menu.

- Hz: Hertz
- kcpm: Kilo Cycles per Minute
- odr: order (Reference frequency set. For setting procedure, see page 68.)

X axis upper limit

Shows the upper limit value of the X axis for the current display range.

Overall value

Shows the total spectrum power (excluding DC components).













Overlay symbol



This appears if overlay display (see page 110) has been selected.

Magnifying glass symbol

This appears in display scaling mode. The SCALE ON/OFF key is used to switch the mode on and off. For details, see pages 69 to 70.

Graph zoom symbol or cursor move symbol

These appear in display scaling mode (see page 69) and show the function of the  /  /  /  keys. When the graph zoom symbol  is shown, the  /  /  /  keys serve to change the zoom factor. When the cursor move symbol  is shown, the  /  keys serve to move the cursor.

The SCALE EXPAND/MOVE key is used to switch between the graph zoom symbol  and the cursor move symbol .

X axis lower limit

Shows the lower limit value of the X axis for the current display range.

Y axis lower limit

Shows the lower limit value of the Y axis for the current display range.





Cursor value readout and unit

This shows the value at the marker symbol  on the cursor. The left value is for the X axis and the right value for the Y axis.



- X axis unit: Set with [X Unit] in [Display] menu. For details, see page 68.
- Y axis unit: Set with [Y Unit] in [Display] menu. For logarithmic scale, select [Log]. For linear scale, select [Linear].

Y axis zoom factor

The Y axis zoom factor for the currently displayed graph is shown here.

- If FFT scale is [Log]:
Each push of  key cycles through settings as follows:
80 dB → 60 dB → 40 dB → 20 dB
Each push of  key cycles through settings as follows:
20 dB → 40 dB → 60 dB → 80 dB
- If FFT scale is [Linear]:
Each push of  key cycles through settings as follows:
 $\times 2^0 \rightarrow \times 2^1 \rightarrow \times 2^2 \rightarrow \dots \times 2^{10}$
Each push of  key cycles through settings as follows:
 $\times 2^{10} \rightarrow \times 2^9 \rightarrow \times 2^8 \rightarrow \dots \times 2^0$

Cursor

The cursor can be moved right and left with the / keys. Holding down a key will move the cursor faster. If the cursor is shown as a broken line, it cannot be moved (see page 70).

Y axis unit

If FFT scale is [Log], the indication [dB] is shown here.

- Acceleration: Referenced to 1 m/s^2
- Velocity: Referenced to 1 mm/s
- Displacement: Referenced to 1 mm
- Envelope: Referenced to 1

If the FFT scale is [Linear], the unit indication changes according to the measurement data type.

- Acceleration: m/s^2
- Velocity: mm/s
- Displacement: mm
- Envelope: No indication

The [FFT Scale] item on the [Display] menu is used to switch.

Y axis upper limit

Shows the upper limit value of the Y axis for the current display range.

Graph display (Other items)

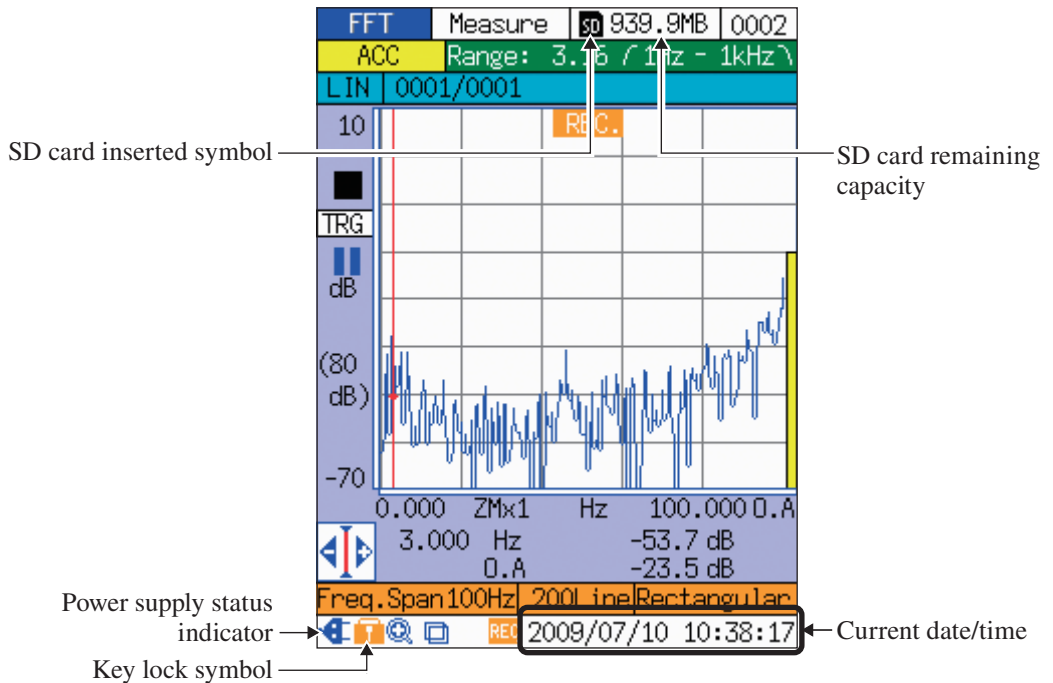

SD card remaining capacity

When an SD card is inserted, the remaining capacity is shown here.

Current date/time



The current date and time are shown here.

For information on how to set the date and time, see the “Preparations” section on pages 18 to 19.

Key lock symbol

Pressing the VM/TIME/FFT key for 2 seconds while holding down the MENU key sets the unit to the key lock condition where all operation keys are disabled, and this symbol  is shown. To cancel the condition, repeat the procedure.

Power supply status indicator

During battery-powered operation, the battery capacity symbol  is shown here. When the unit is powered from an external source, the AC power symbol  is shown here. For details, see the “Power Supply” section on page 120.

SD card inserted symbol

Appears when an SD card is inserted into the unit.

List display

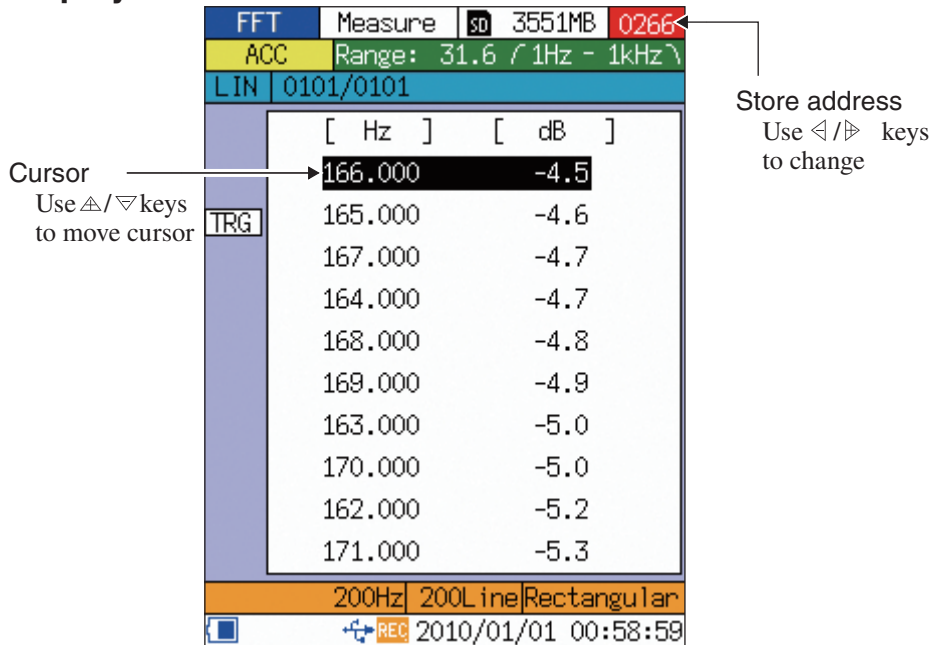

Pressing the VM/TIME/FFT key in graph display mode switches to list display. The ten highest level values out of the data range covered by the graph display are listed, in descending order.

Switching to graph display

Use the VM/TIME/FFT key to switch to graph display. However, in the following cases, the unit will switch to vibration meter mode:

- When INST is shown as operation type and the unit is not in pause mode
- During processing standby (see page 71)

The ENT key can also be used to switch to graph display. In that case, the cursor on the graph screen will move to the position of the frequency that was selected on the list screen. In the screen example shown above, pressing the ENT key would move the cursor to the 100 Hz position.

Note

If the display has been cleared for the trigger standby condition, pressing the ENT key has no effect. Pressing the VM/TIME/FFT key will switch to graph display.

Changing measurement parameters and display parameters

The measurement parameters and display parameters in FFT mode are as follows.

		Menu	Key operation	See page
Measurement parameter	Sensor information	Analog Input	—	16, 65
	High-pass filter	Analog Input	—	56
	Low-pass filter	Analog Input	—	56
	Measurement data type	—	ACC/VEL/DISP	58
	Input range	—	RANGE \triangle / ∇	56
	Frequency span	Measure	FREQ SPAN	57
	Number of analysis lines	Measure	LINE	57
	Trigger operation settings	Measure	—	93 to 96
	Window function	FFT	—	57
	Operation type	FFT	—	67
	Average number	FFT	—	67
	Store name	Measure	—	67
	Waveform data recording function	Measure	—	77
Display parameter	FFT scale	Display	—	68
	Cursor X axis unit	Display	—	68
	Cursor Y axis unit	Display	—	62
	Overlay display	Display	—	110

For information on menu structure and menu operation, see the “Menu Operation” section.

Making sensor settings

Use the supplied calibration chart of the accelerometer you intend to use, and make the sensitivity setting by performing the following steps.

1. From the [Analog Input] menu screen, select [Sensor Selection] and then [PV-57I] or [Other].
2. Set [Sensitivity] to the sensitivity value given on the calibration chart.

Note

When selecting [PV-57I], a popup window appears, asking whether you want to change the sensitivity setting. Also, note that the factor cannot be changed.

Changing the input range

Set the input range to an optimum setting.

If the overload indication (**Over** or Over) appears on the left side of the display, the input range setting is too low. Use the RANGE Δ key to increase the setting (see left illustration below).

If the graph is shifted too far down, the input range setting is too high. Use the RANGE ∇ key to decrease the setting (see right illustration below).

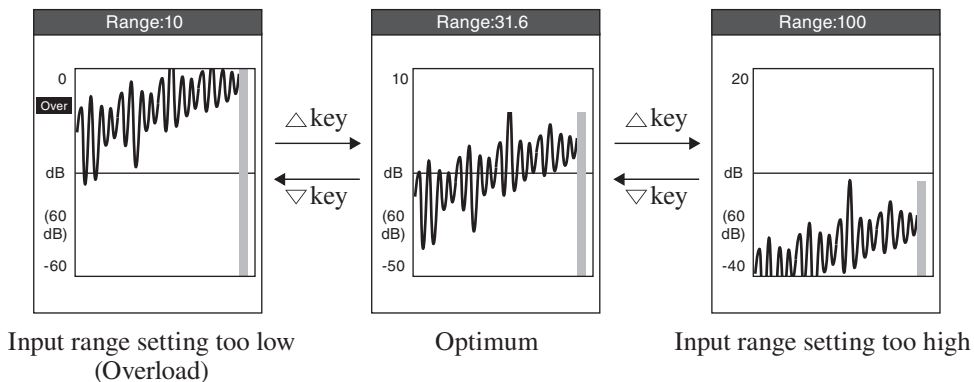

Relation between RANGE Δ / ∇ keys and display (FFT scale is [Log])

The overload indication timing is as follows.

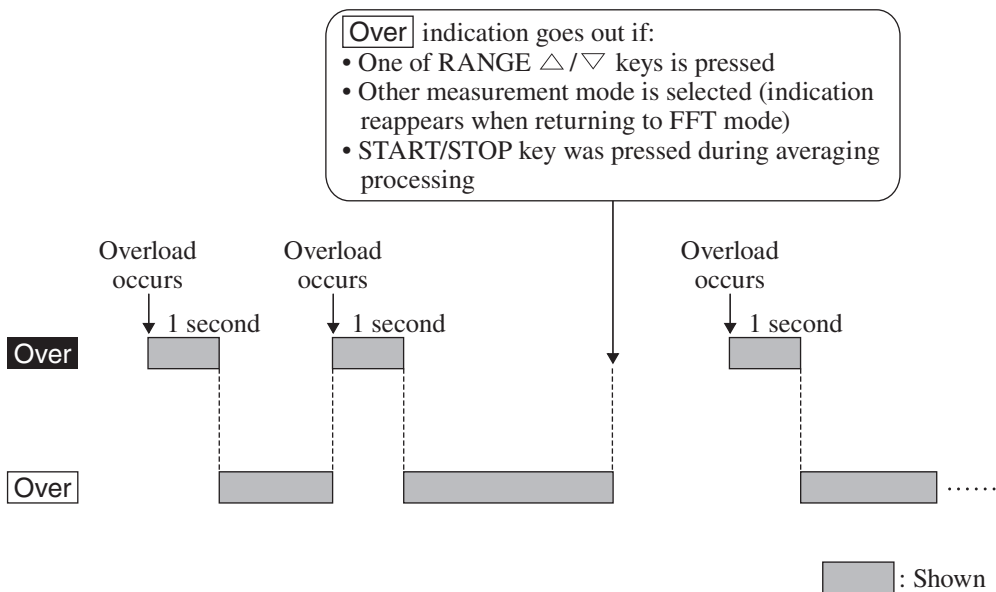

Selecting the operation type

Make the setting with the [Operation Type] item in the [FFT] menu.

- LIN: Linear average
- EXP: Exponential average
- MAX: Maximum hold

Note
Instantaneous value cannot be selected from the [FFT] menu. Press the INST/AVE key at the [FFT] mode screen to display the instantaneous value.

Setting the average number

Make the setting for the number of averaging runs with the [Average number] item in the [FFT] menu.

For information on the relation between the operation type and the averaging number, see the “Performing measurement” section on page 71.

Specifying the store name

To store measurement data, it is necessary to first specify a store name. Access the [Measure] menu and select [Store Name].

Measurement data will be stored in a folder of the specified name. (See the “SD Card” section.)

Conditions for changing measurement parameters
If [LIN], [EXP], or [MAX] is shown as [Operation Type], measurement parameters cannot be changed during processing and during trigger standby.
While processing is paused (■ symbol shown at the left side of the screen), measurement parameters cannot be changed.
During trigger operation, measurement parameters cannot be changed.

Setting the FFT scale type

Make the setting for the FFT scale (Y axis scale) with the [FFT Scale] item in the [Display] menu.

- Log: Logarithmic scale
- Linear: Linear scale

Setting the cursor X axis unit

1. At the [Display] menu screen, select [X Unit] and press the ENT key.
2. Use the \triangle / ∇ keys to select [Hz], [kcpm], or [odr], and press the ENT key.
 - Hz: Hertz
 - kcpm: Kilo Cycles per Minute
 - odr: Set reference frequency (order).
3. When [odr] was selected, you should set the reference frequency using one of the two methods described below.

Method 1

Select [Standard Frequency] and enter the value by direct edit.



Method 2

- (1) At the graph screen, move the cursor to the frequency you want to set.
- (2) Select [odr] for [X Unit] in the [Display] menu.
- (3) Press the STORE key.

Zooming/moving the display

To expand or shrink the display, proceed as follows.

1. Enable the display scaling/zoom mode (graph zoom symbol  shown at the bottom left of graph) (see illustration below).

If the magnifying glass symbol  is shown, the unit is in display scaling mode. Press the SCALE EXPAND/MOVE key as required. If the magnifying glass symbol  is not shown, first press the SCALE ON/OFF key to switch the unit to display scaling mode. Then press the SCALE EXPAND/MOVE key as required.

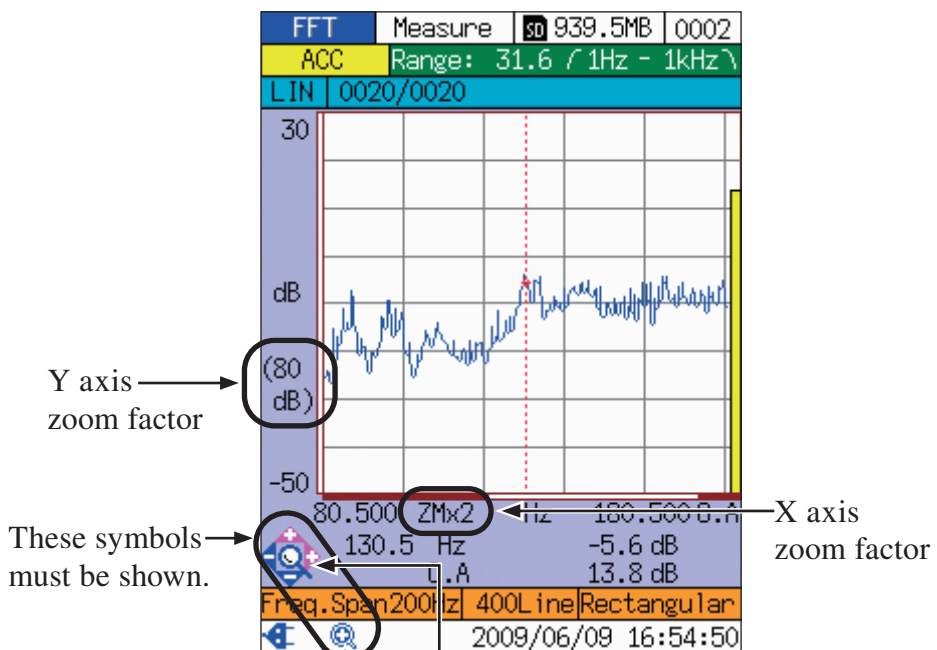

2. To zoom along the X axis, use the \leftarrow / \rightarrow keys. The zoom factor is shown at the bottom of the graph. To zoom along the Y axis, use the \triangle / ∇ keys. The zoom factor is shown at the left of the graph.



: Display scaling mode
: Zoom mode
: Move mode

Not shown: Overall data display mode

Functions of ◀ / ▶ / ▲ / ▼ keys differ, according to display mode

Display mode	Symbol	Cursor	Key operation			
			◀	▶	▲	▼
Overall data display	None	Solid line	Move cursor left *	Move cursor right *	Increment store address (+)	Decrement store address (-)
Display scaling/zoom		Broken line	Shrink X axis	Expand X axis	Expand Y axis	Shrink Y axis
Display scaling/move		Solid line	Move cursor left *	Move cursor right *	Increment store address (+)	Decrement store address (-)

* When the cursor is near the display edge, the cursor does not move but the display is scrolled. When the edge is reached, the cursor moves to the other edge. When the X axis display range is not 100%, the screen also scrolls to the other edge.

Relation between overall data and display range

In display scaling/zoom mode, scroll bars are shown to indicate which section of the overall data is currently shown on the display.

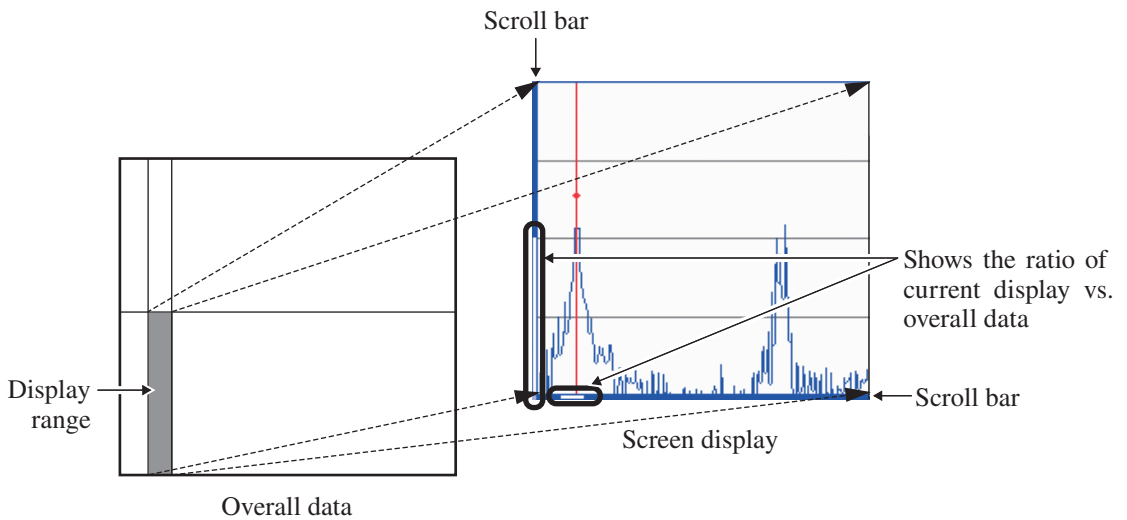

Performing measurement

The operation principles for measurement in FFT mode are explained in this section.

For information on measurement using the trigger functions, see the “Trigger Functions” section.

Operation type overview

The chart below shows an outline of the various operation types.

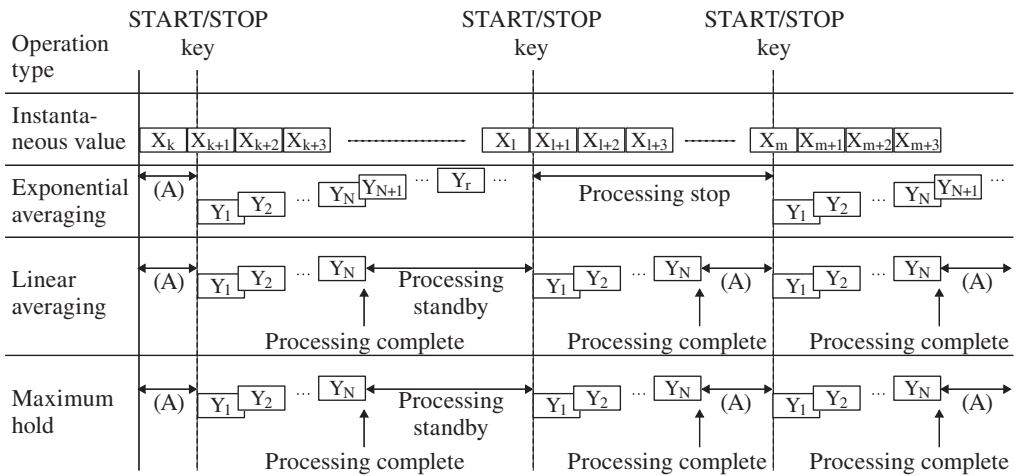

Exponential averaging	$Y_k = \frac{(N-1)Y_{k-1} + X_k}{N}$	$k = 1, 2, \dots, r, \dots$	Y_k : k-th average value
Linear averaging	$Y_k = \frac{\sum_{i=1}^k X_i}{k}$	$k = 1, 2, \dots, N$	X_k : k-th instantaneous value
			N: Preset average number
			(A): Processing standby

Maximum hold Maximum value of $Y_k = X_1$ to X_k

The meaning of the [Average number] (N in the above diagram) set in the [FFT] menu differs, depending on whether exponential averaging or linear averaging (or maximum hold) is selected.

Frequency resolution (Δf) and frame time (T_{Frame})

The frame time duration is determined by the number of analysis lines and the frequency span. The values are shown in the table below.

Number of analysis lines \ Frequency span	200 lines		400 lines		800 lines		1600 lines		3200 lines	
	T_{Frame} (sec)	Δf (Hz)	T_{Frame} (sec)	Δf (Hz)	T_{Frame} (sec)	Δf (Hz)	T_{Frame} (sec)	Δf (Hz)	T_{Frame} (sec)	Δf (Hz)
100 Hz	2.00	0.5	4.00	0.25	8.00	0.125	16.00	0.0625	32.00	0.03125
200 Hz	1.00	1.0	2.00	0.50	4.00	0.250	8.00	0.1250	16.00	0.06250
500 Hz	0.40	2.5	0.80	1.25	1.60	0.625	3.20	0.3125	6.40	0.15625
1 kHz	0.20	5.0	0.40	2.50	0.80	1.250	1.60	0.6250	3.20	0.31250
2 kHz	0.10	10.0	0.20	5.00	0.40	2.500	0.80	1.2500	1.60	0.62500
5 kHz	0.04	25.0	0.08	12.50	0.16	6.250	0.32	3.1250	0.64	1.56250
10 kHz	0.02	50.0	0.04	25.00	0.08	12.500	0.16	6.2500	0.32	3.12500
20 kHz	0.01	100.0	0.02	50.00	0.04	25.000	0.08	12.5000	0.16	6.25000

FFT calculation interval: Δt (sec)

Number of analysis lines \ Frequency span	200 lines	400 lines	800 lines	1600 lines	3200 lines	Frame time ratio
100 Hz	0.25 sec	0.5 sec	1.0 sec	2.0 sec	4.0 sec	1/8
200 Hz	0.125 sec	0.25 sec	0.5 sec	1.0 sec	2.0 sec	1/8
500 Hz	0.1 sec	0.2 sec	0.4 sec	0.8 sec	1.6 sec	1/4
1 kHz	0.1 sec	0.2 sec	0.4 sec	0.8 sec	1.6 sec	1/2
2 kHz	0.1 sec	0.2 sec	0.4 sec	0.8 sec	1.6 sec	1/1
5 kHz	0.04 sec	0.08 sec	0.16 sec	0.32 sec	0.64 sec	1/1
10 kHz	0.02 sec	0.04 sec	0.08 sec	0.16 sec	0.32 sec	1/1
20 kHz	0.01 sec	0.02 sec	0.04 sec	0.08 sec	0.16 sec	1/1

Note 1 The FFT calculation interval is a value specific to the VA-12.

Note 2 The time required until the first FFT processing results is displayed is equal to the frame time.

Performing instantaneous value measurement

1. Make the required measurement parameter and display parameter settings using the [FFT] menu, [Measure] menu, etc. (see page 65).
2. Repeatedly press the VM/TIME/FFT key to bring up the FFT mode screen.
3. Press the INST/AVE key so that [INST] is shown as operation type at the top left of the screen.
4. Select the input range, frequency span, number of analysis lines and other parameters to obtain optimum measurement data (see page 65).

Performing exponential averaging value measurement

1. Make the required measurement parameter and display parameter settings using the [FFT] menu, [Measure] menu, etc. (see page 65). Set [Operation Type] in the [FFT] menu to [EXP].
2. Repeatedly press the VM/TIME/FFT key to bring up the FFT mode screen.
3. Press the INST/AVE key so that [EXP] is shown as operation type at the top left of the screen.
4. Select the input range, frequency span, number of analysis lines and other parameters to obtain optimum measurement data (see page 65).

Note
During processing, settings such as input range, frequency span, and the number of analysis lines cannot be changed. Press the START/STOP key only after having set these parameters.

5. Press the START/STOP key to begin the measurement. The screen display is updated continuously.

Performing linear averaging or maximum hold measurement

1. Make the required measurement parameter and display parameter settings using the [FFT] menu, [Measure] menu, etc. (see page 65). Set [Operation Type] in the [FFT] menu to [LIN] or [MAX].
2. Repeatedly press the VM/TIME/FFT key to bring up the FFT mode screen.
3. Press the INST/AVE key so that [LIN] or [MAX] is shown as operation type at the top left of the screen.
4. Select the input range, frequency span, number of analysis lines and other parameters to obtain optimum measurement data (see page 65).

Note
During processing, settings such as input range, frequency span, and the number of analysis lines cannot be changed. Press the START/STOP key only after having set these parameters.

5. Press the START/STOP key to begin the measurement. Measurement value processing is carried out for the selected number of averaging runs.

Storing measurement data

You can store measurement data on an SD card inserted in the unit.



When the trigger function is enabled, refer to the “Trigger Functions” section.

Important
While the LED indicator is flashing, do not turn off power to the unit or remove the SD card.

Note
<p>If the waveform recording function (see page 77) has been set to [On], WAVE files will be stored on the SD card along with the FFT data store files. However, this applies only in the following cases:</p> <ul style="list-style-type: none"> • Exponential averaging processing is in progress or paused. • Linear averaging or maximum hold processing is paused or completed. <p>If the operation type is instantaneous value measurement, WAVE files are not stored.</p> <p>For information on the data storage location, see the “SD Card” section.</p> <p>If measurement parameters are changed after processing, the display is cleared, but the previous data and measurement parameters are maintained. Consequently, if the STORE key is pressed at this point, the measurement parameters that will be stored are the parameters that were active during processing.</p>

1. Verify that the SD card symbol  is shown on the title bar.
If no symbol is shown, insert an SD card.

2. Check the store address shown at the right end of the title bar.
 - If the address is shown on a white background:
Proceed to step 3.
 - If the address is shown on a red background:
This indicates that the store address already contains measurement data. If the data can be overwritten, proceed to step 3.
If you do not want to overwrite the data, use the \triangle / ∇ keys to select a different store address that is shown on a white background.

Note
<p>If the graph zoom symbol  is shown at the bottom left of the graph, press the SCALE EXPAND/MOVE key or the SCALE ON/OFF key. Verify that the symbol is now  or that no symbol is shown, and then use the \triangle / ∇ keys.</p>

3. Press the STORE key.
4. The popup indication “STORE XXXX” (where XXXX is the store address) appears, storing is carried out, and the LED indicator flashes in red.
When storing is complete, the store address is incremented by one.
If the store address was 1000, the indication returns to 0001.

For information on how to view stored data, refer to the “Recalling Stored Data” section. For information on the folder structure of stored data, refer to the “SD Card” section.

Recording Waveform Data

The VA-12 can record waveform data in files of up to 1 MB per recording operation. The recorded waveform information is stored as a RIFF format WAVE file along with the FFT store data on the SD card.

- For information on the data storage location, see page 126.
- Waveform data that are stored are vibration waveform data collected while processing is performed.

Making waveform recording settings

To use the waveform recording capability, the function must be enabled beforehand in the [Measure] menu.

1. From the [Measure] menu screen, select [Wave Record].
2. To use waveform recording, select the [ON] setting. Otherwise, select the [OFF] setting.
3. When the FFT mode screen is displayed, the waveform recording indication **REC** is shown on the status bar. However, the indication will not appear if the operation type is instantaneous value measurement because waveform recording is only enabled while processing is carried out.

Depending on the wave recording setting, recording may not be possible for certain combinations. Please refer to the table below.

		FFT Calculation interval (ms)							
		Frequency span							
		100 Hz	200 Hz	500 Hz	1000 Hz	2000 Hz	5000 Hz	10000 Hz	20000 Hz
Analysis lines	200	250	125	100	100	100	40	20	10
	400	500	250	200	200	200	80	40	20
	800	1000	500	400	400	400	160	80	40
	1600	2000	1000	800	800	800	320	160	80
	3200	4000	2000	1600	1600	1600	640	320	160

With the shaded combinations, waveform dropouts will occur. When using the waveform recording function, you should therefore stop recording so that the shaded combinations are not used.

Recording waveform data

1. Display the FFT mode measurement screen.
2. Store the measurement data (see page 75).
If the waveform recording function is set to [ON], waveform data will also be stored at this point. However, this applies only in the following cases:
 - Exponential averaging processing is in progress or paused
 - Linear averaging or maximum hold processing is paused or completed

Note
If the operation type is instantaneous value measurement, waveform data are not stored.
The duration of the recorded waveform data depends on the averaging count. As a rough guideline, the maximum file size is 1 MB, which corresponds to about 10 seconds at a sampling frequency of 51.2 kHz.
During processing, the waveform recording in the progress indicator REC. is flashing in the top section of the graph.
When data are stored after processing, or at the point when data are stored after averaging processing was stopped by pressing the START/STOP key, the waveform data used for averaging processing are recorded. However, more than 1 MB cannot be recorded.

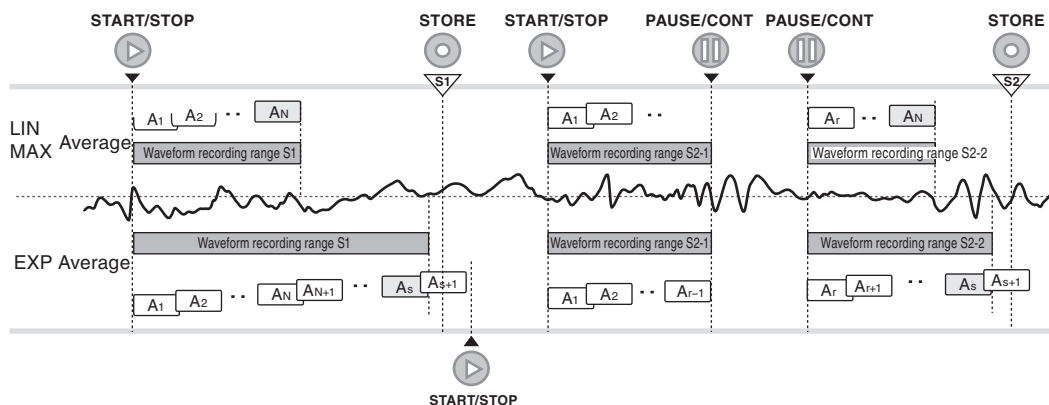

Waveform data store range

(When STORE key is pressed, the most recent waveform data used for averaging processing are stored as waveform data.)

- The maximum WAVE file size that can be stored is 1 MB. When the waveform recording range is longer than this, only more recent data are stored and older data are discarded, to keep the WAVE file size under 1 MB.
- The data available when the S2 STORE key is pressed are non-contiguous because the measurement was paused midway. In the WAVE file, the waveform data of the two sections will be joined.

Re-analyzing waveform data

The optional waveform analysis software AS-70 or CAT-WAVE can be used to re-analyze the waveform data.

Re-analyzing on the VA-12 itself is not possible.

Recalling Stored Data

Procedure for recalling stored data

1. Press the MENU key to display the [Menu List] screen.
2. Use the \triangle / ∇ / \leftarrow / \rightarrow keys to select [Recall] and press the ENT key.
3. The [Recall/Select File] screen is shown. Use the \triangle / ∇ keys to select the store name and press the ENT key.

Important

If no SD card is inserted, the store name is not displayed. In that case, insert an SD card first (see page 17).

The screenshot shows the [Recall/Select File] screen with the following data:

Name	Date	001/001
MAN_0710	2009/07/10 10:36	
MAN_0611	2009/06/11 17:14	
REC MAN_0609	2009/06/09 14:24	

Annotations:

- An arrow points to the 'REC' icon next to 'MAN_0609' with the text: "Indicates that the folder contains waveform data."
- An arrow points to the date/time '2009/06/11 17:14' with the text: "The measurement date/time indicated here is the date/time when the folder was created."

At the bottom of the screen, there are control options:

- Apply \rightarrow ENTER
- Delete Data \rightarrow PAUSE
- Return \rightarrow MENU
- Measurement Screen \rightarrow START

The bottom status bar shows: \leftarrow REC 2009/07/10 10:43:01

[Recall/Select File] screen

- The lower part of the [Recall/Select File] screen changes into a [Recall Address] menu which specifies the address number, as shown below. Use the Δ / ∇ keys to increase or decrease the address number. When the correct address is shown, press the ENT key. Only addresses that actually contain saved data can be selected. (When the [Recall Address] menu appears, the lowest address containing saved data is shown.)

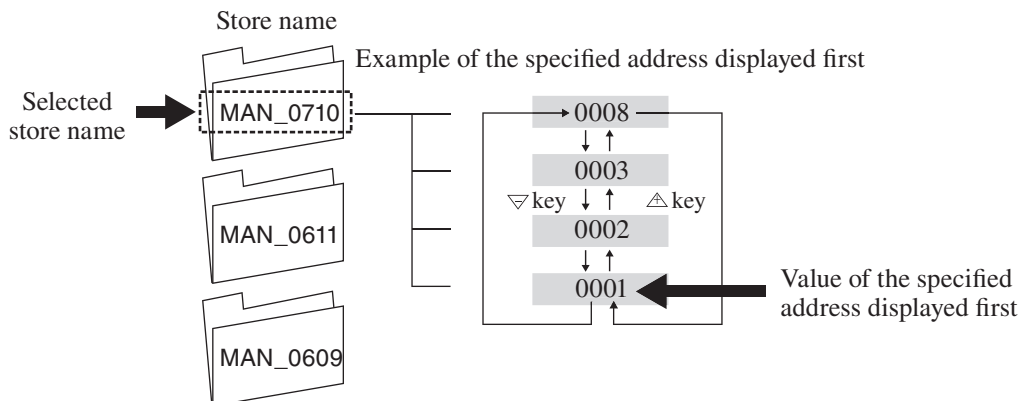
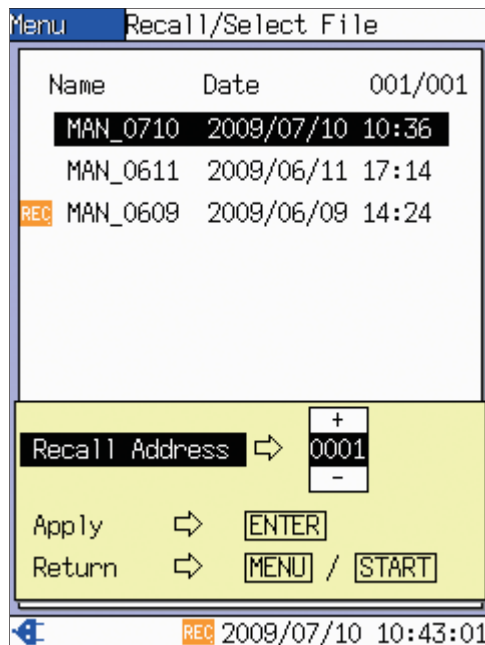

5. The data in the folder with the store name specified in step 3 and the store address specified in step 4 are displayed.

For an explanation of the recall screen, see the next page.

Important

It may take several seconds for the data to appear. While the LED indicator is flashing, do not turn off power to the unit or remove the SD card.



6. To display data in other store addresses, use the \triangle / ∇ keys. If the specified store address contains no saved data, the data in the nearest lower store address that contains data are displayed.

The principle here is the same as for the specified address described on the previous page.

Example: If the store addresses 0001, 0002, 0003, and 0008 contain data and store address 0006 is specified, the data in store address 0003 will be displayed.

Note

When the address doesn't change:

If the graph zoom symbol  is shown at the bottom left of the graph, press the SCALE EXPAND/MOVE key or the SCALE ON/OFF key. Verify that the symbol is now  or that no symbol is shown, and then use the \triangle / ∇ keys.

Reading the recall screen

This section explains peculiar items of the recall screen.

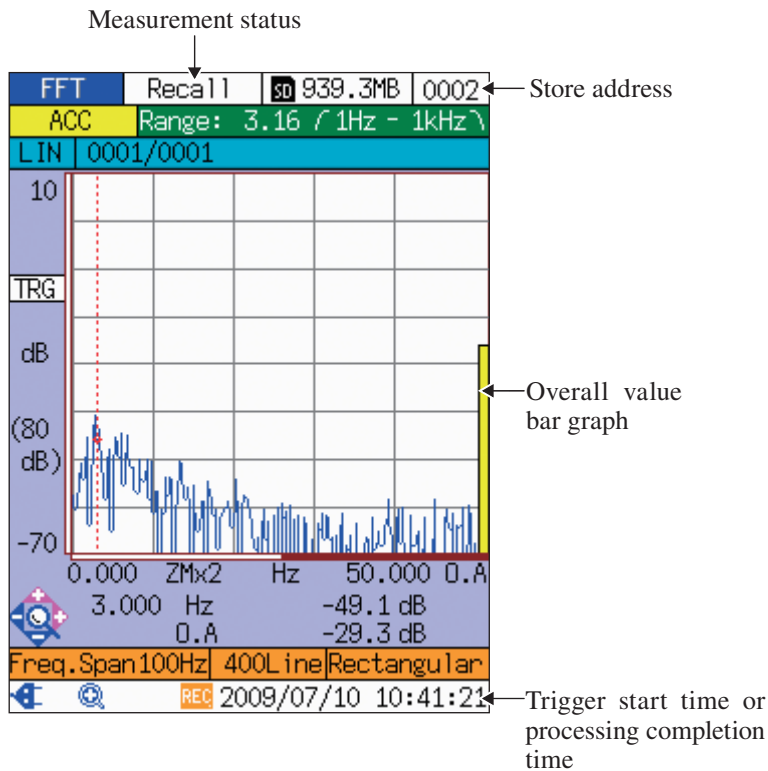

Recall screen (in FFT mode)

Measurement status

Shows "Recall".

Store address

Shows the address whose data are currently displayed.

To select other data for display, use the Δ / ∇ keys (see page 80).

Overall value bar graph

The overall value (spectrum power sum without DC components) is shown in yellow.

Trigger start time or processing completion time

When time store was used, the trigger start time is shown. When manual-store was used, the processing completion time is shown.

Changing the display

The procedure is in principle the same as for the measurement screen.

However, the VM/TIME/FFT key functions as follows.

Vibration meter mode: Key has no effect

Time waveform mode: Key has no effect

FFT mode: Toggles between graph display and list display

The steps for changing the display according to the analysis function are as listed below.

Vibration meter mode

The ACC/VEL/DISP key can be used to change the measurement data type (data shown as bar graph).

Time waveform mode

The display can be zoomed in or out (see pages 51 to 52).

FFT mode

The display can be zoomed in or out (see pages 69 to 70).

The cursor X axis unit, cursor Y axis unit, and FFT scale (Y axis display scale) can be changed.

Deleting stored data

You can delete stored data from the SD card using the VA-12.

Note

When using the VA-12, only complete folders indicated by specifying the store name can be deleted (see illustration below). To delete data in a specific store address only, you must use a computer as described in the “SD Card” section on page 126.

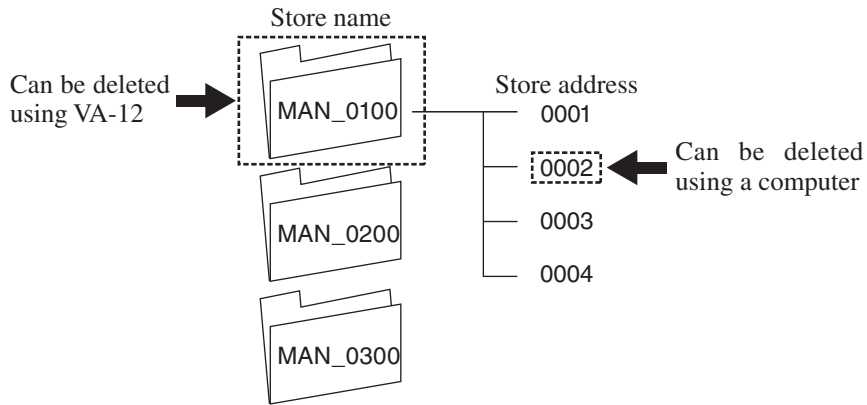

To delete a folder, select the store name from the [Recall/Select File] screen and press the PAUSE/CONT key.

Saving the Screen as a BMP File

The VA-12 allows storing the current screen image as a BMP file in a specified folder on the SD card.

Saving the measurement screen or recall screen

1. Display the measurement screen or recall screen.
2. Verify that the SD card symbol  is shown on the title bar.
If no symbol is shown, insert an SD card.
3. Press the MENU key when the measurement screen is displayed, or press the ENT key when the recall screen is displayed.
4. Use the \triangle / ∇ / \triangleleft / \triangleright keys to select [Print] and press the ENT key.
5. The [Print] popup window appears. Use the \triangle / ∇ keys to select [Save to SD] and press the ENT key.

Important
If no SD card is inserted, an error message appears to alert the user. In such a case, insert an SD card.
While the LED indicator is flashing, do not turn off power to the unit or remove the SD card.

Screen hard copy

When you press the ENT key while holding down the MENU key, the LED indicator flashes and the current screen contents will be saved as a BMP file on the SD memory card.

Displaying a BMP file

Stored BMP files can be viewed on a computer. For information on the data storage location, see the “SD Card” section.

Printing

Connecting the Printer BL-112UI to the VA-12 (see page 21) allows printout of the measurement screen and recall screen.

Printing the measurement screen

1. Display the measurement screen.
2. Press the MENU key.
3. Use the \triangle / ∇ / \triangleleft / \triangleright keys to select [Print] and press the ENT key.
4. The [Print] popup window appears. Use the \triangle / ∇ keys to select [Print] and press the ENT key.
To save the screen as a BMP file, select [Save to SD] and press the ENT key.

Printing the recall screen

1. Display the recall screen. (See the “Recalling Stored Data” section.)
2. Press the ENT key.
3. Use the \triangle / ∇ / \triangleleft / \triangleright keys to select [Print] and press the ENT key.
4. The [Print] popup window appears. Use the \triangle / ∇ keys to select [Print] and press the ENT key.
To save the screen as a BMP file, select [Save to SD] and press the ENT key.

Printing stored data continuously

For data stored in vibration meter mode and FFT mode, it is possible to specify a range from the data list and print the specified range continuously.

1. Recall the stored data to be printed. (See the “Recalling Stored Data” section.)
2. Press the ENT key.
3. Use the \triangle / ∇ / \triangleleft / \triangleright keys to select [Print] and press the ENT key.
4. The [Print] popup window appears. Use the \triangle / ∇ keys to select [Type] and press the ENT key.
5. Use the \triangle / ∇ keys to select [List] and press the ENT key.
6. Use the \triangle / ∇ keys to select [Address] and press the ENT key.
7. Use the \triangle / ∇ keys to select the data range to print and press the ENT key.
8. Use the \triangle / ∇ keys to select [Print] and press the ENT key.
To save the data as a BMP file, select [Save to SD] and press the ENT key.

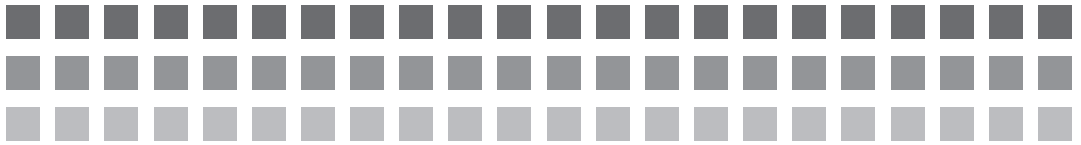

Advanced Operation



Trigger Functions

The trigger functions of the VA-12 can be used for each analysis mode except for FFT mode (instantaneous value). Four types of trigger operation modes are available: [Free], [Repeat], [Single], [Time]. In vibration meter mode, only [Free] and [Time] are available.

Trigger operation modes

Free

In this mode, processing is carried out constantly, regardless of the trigger condition.

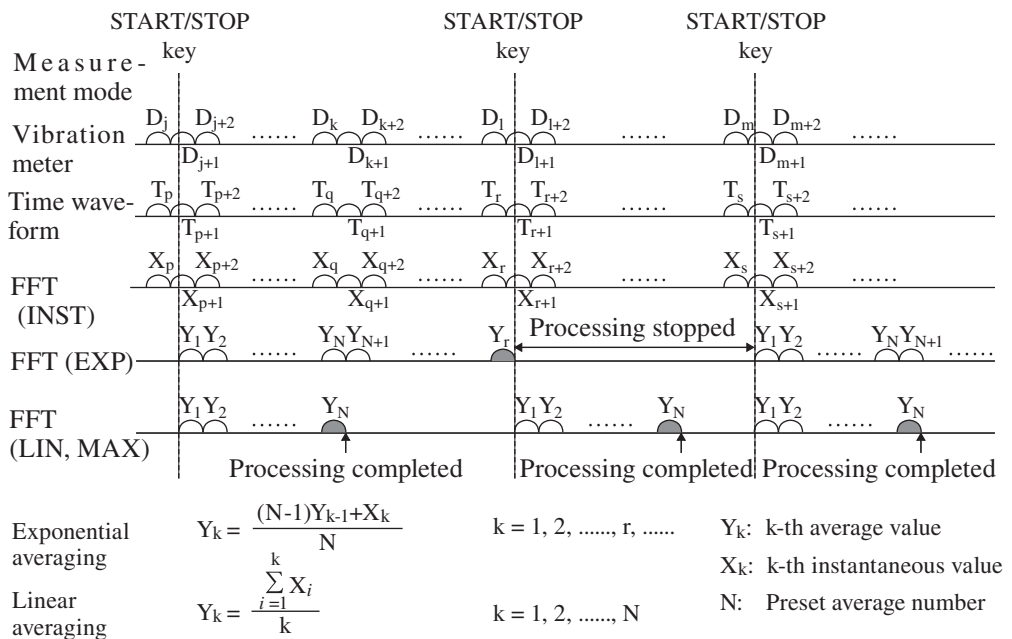

Repeat

Processing is carried out every time the trigger condition is met.

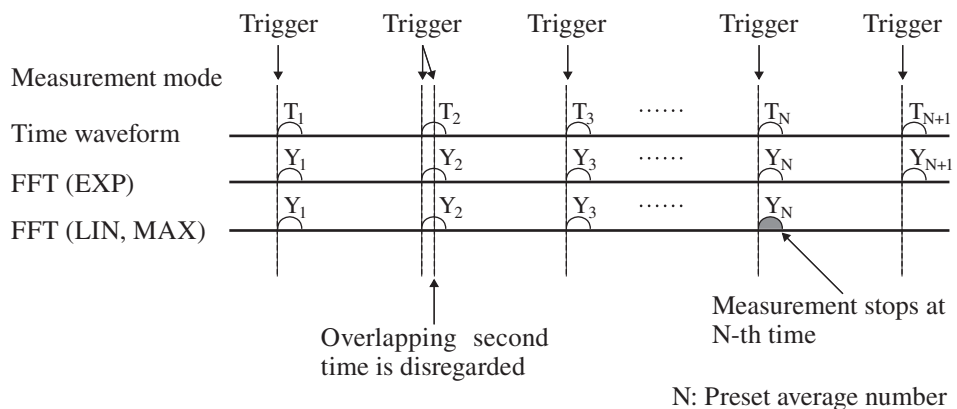

Single

Processing is only carried out once, at the first trigger occurrence. However, in FFT mode (exponential averaging), processing continues from the first trigger occurrence until the START/STOP key is pressed.

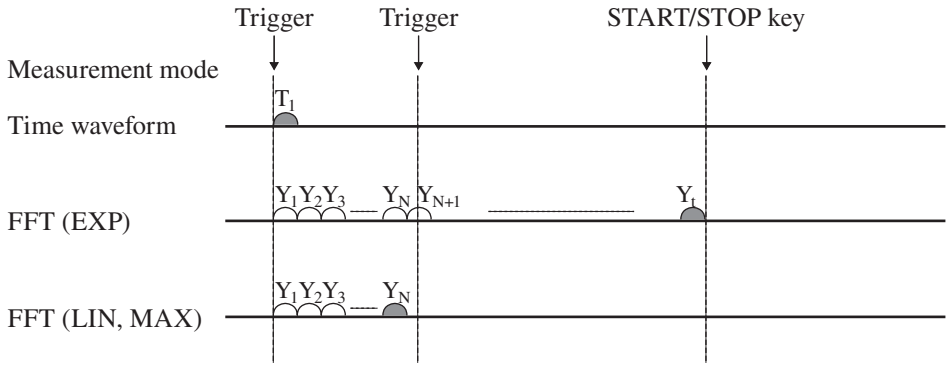

N: Preset average number

Time

Beginning from the measurement start time, data are stored at preset intervals, and for a preset number of times (store number).

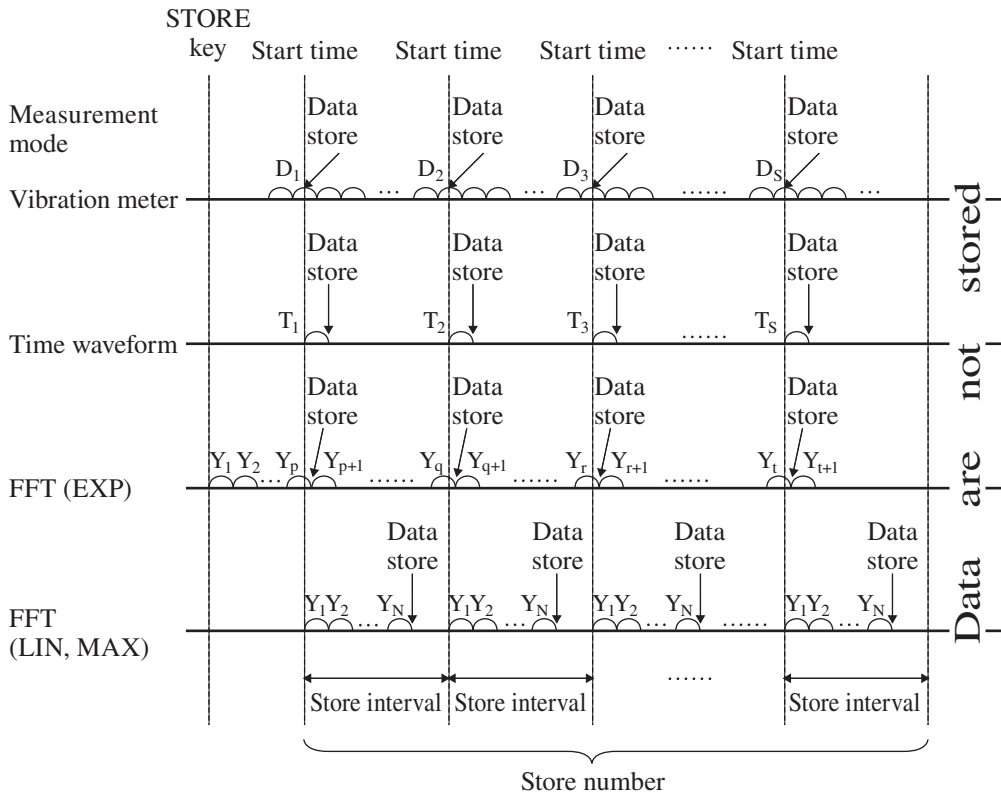

N: Preset average number
 S: Preset store number

Making trigger settings

Making settings for repeat trigger and single trigger

Note
In vibration meter mode, any settings for repeat trigger and single trigger will be disregarded, and the operation is the same as in free trigger mode.

Making settings

1. From the [Measure] menu screen, select [Trigger Mode] and set it to [Repeat] or [Single].
2. If performing measurement in FFT mode, select [Wave Record]. For information on waveform recording, see the “Recording Waveform Data” section.
3. Make the appropriate setting for [Trigger Source].
 Level: Level trigger (See “Level trigger” section below.)
 External: External trigger (See “External trigger” section on next page.)
4. Make the appropriate setting for [Pre-Trigger]. (See “Pretrigger” section on the next page.)
 OFF: Pretrigger is disabled.
 ON: Pretrigger is enabled.

Note
The VA-12 does not have a post trigger function.

5. When the [Trigger Source] has been set to [Level], the [Trigger Level] and [Slope] items must be set. (See “Level trigger” section below.)

Level trigger

When the input level reaches the trigger level, processing starts.

The trigger level can be set in steps of 1/8 of the full-scale level.

The direction (slope) from which the input level approaches the trigger level can be set to + or –.

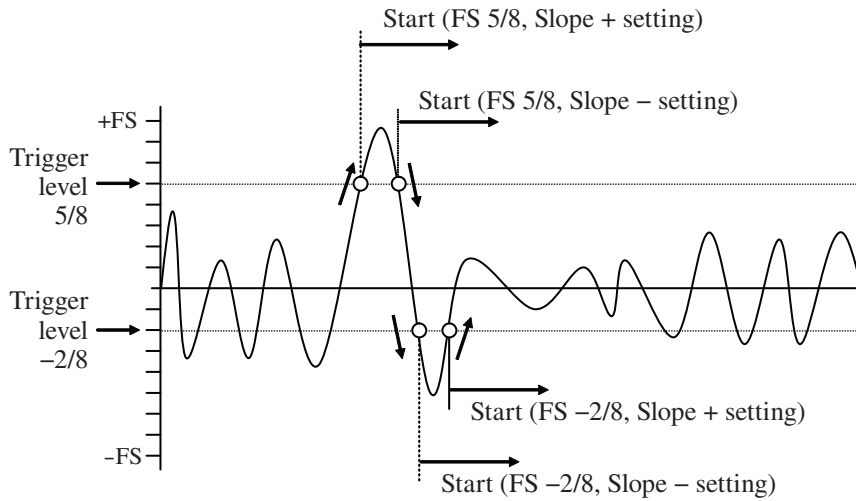

External trigger

Processing starts when an external signal is input.

When the falling edge of a TTL level signal (minimum pulse $10\ \mu s$) is detected, or when the input is shorted, triggering occurs.

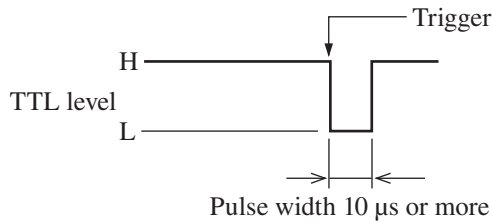

Pretrigger

When triggering occurs, processing starts and includes the data from a point preceding the current point by $1/8$ frame time.

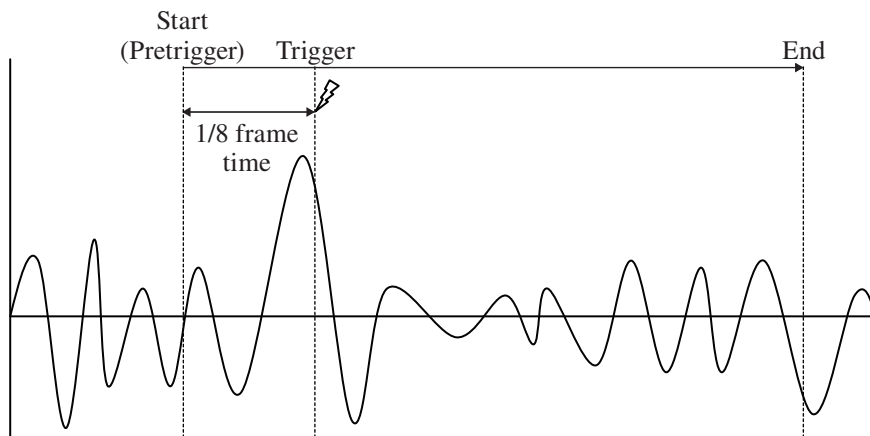

Making time trigger settings

1. From the [Measure] menu screen, select [Store Name].
The measurement data will be stored in the folder specified by the [Store Name] item. (For details, see the “SD Card” section.)
2. Set the [Trigger Mode] to [Time].
3. If performing measurement in FFT mode, select [Wave Record]. For information on waveform recording, see the “Recording Waveform Data” section.
4. Make the settings for [Trigger Start Time], [Store Interval], and [Store number]. For details on these items, see page 92.

Note

In FFT mode (linear averaging, maximum hold), the available setting range for the number of averaging runs is limited, depending on the frequency span, number of analysis lines, and store interval settings. (See tables below.)

Frequency span(Hz)	Number of lines	Frame time(s)	Overlap ratio *	Max. averaging				
				1 min. (60 sec)	5 min. (300 sec)	10 min. (600 sec)	30 min. (1800 sec)	60 min. (3600 sec)
100	200	2	0.875	225	1185	2048	2048	2048
100	400	4	0.875	109	589	1189	2048	2048
100	800	8	0.875	51	291	591	1791	2048
100	1600	16	0.875	22	142	292	892	1792
100	3200	32	0.875	7	67	142	442	892
200	200	1	0.875	457	2048	2048	2048	2048
200	400	2	0.875	225	1185	2048	2048	2048
200	800	4	0.875	109	589	1189	2048	2048
200	1600	8	0.875	57	291	591	1791	2048
200	3200	16	0.875	22	142	292	892	1792
500	200	0.4	0.75	577	2048	2048	2048	2048
500	400	0.8	0.75	287	1487	2048	2048	2048
500	800	1.6	0.75	142	742	1492	2048	2048
500	1600	3.2	0.75	69	369	744	2048	2048
500	3200	6.4	0.75	33	183	370	1120	2048

Frequency span(Hz)	Number of lines	Frame time(s)	Overlap ratio *	Max. averaging				
				1 min. (60 sec)	5 min. (300 sec)	10 min. (600 sec)	30 min. (1800 sec)	60 min. (3600 sec)
1000	200	0.2	0.5	579	2048	2048	2048	2048
1000	400	0.4	0.5	289	1489	2048	2048	2048
1000	800	0.8	0.5	144	744	1494	2048	2048
1000	1600	1.6	0.5	71	371	746	2048	2048
1000	3200	3.2	0.5	35	185	372	1122	2048
2000	200	0.1	0	580	2048	2048	2048	2048
2000	400	0.2	0	290	1490	2048	2048	2048
2000	800	0.4	0	145	745	1495	2048	2048
2000	1600	0.8	0	72	372	747	2048	2048
2000	3200	1.6	0	36	186	373	1123	2048
5000	200	0.04	0	1450	2048	2048	2048	2048
5000	400	0.08	0	725	2048	2048	2048	2048
5000	800	0.16	0	362	1862	2048	2048	2048
5000	1600	0.32	0	181	931	1868	2048	2048
5000	3200	0.64	0	90	465	934	2048	2048
10000	200	0.02	0	2048	2048	2048	2048	2048
10000	400	0.04	0	1450	2048	2048	2048	2048
10000	800	0.08	0	725	2048	2048	2048	2048
10000	1600	0.16	0	362	1862	2048	2048	2048
10000	3200	0.32	0	181	931	1868	2048	2048
20000	200	0.01	0	2048	2048	2048	2048	2048
20000	400	0.02	0	2048	2048	2048	2048	2048
20000	800	0.04	0	1450	2048	2048	2048	2048
20000	1600	0.08	0	725	2048	2048	2048	2048
20000	3200	0.16	0	362	1862	2048	2048	2048

* Even if the overlap ratio is 0, there will be no dropping of waveform samples during processing (except when repeat trigger is used).

Performing measurement with repeat trigger

Time waveform mode

The operation principle when using time waveform mode is illustrated below.

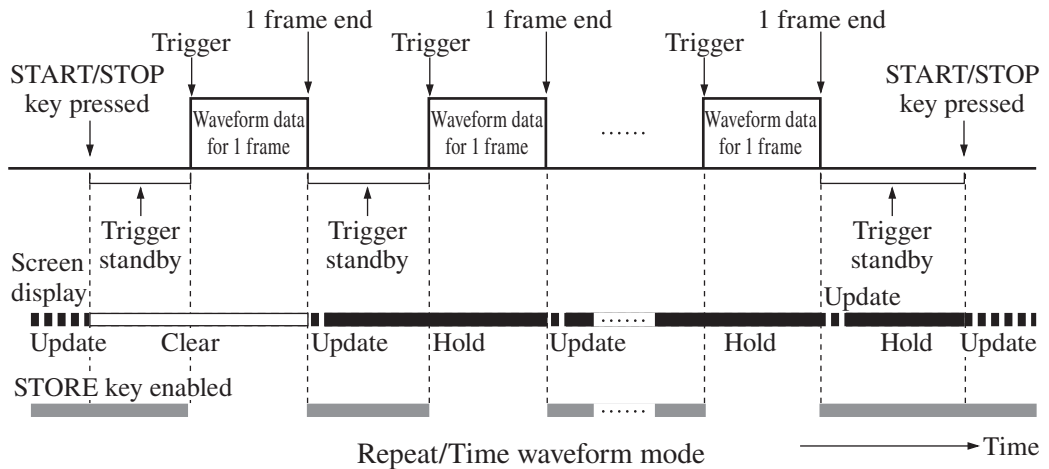

1. Make the required measurement parameter settings.

Note

During the trigger operation, measurement parameters such as the input range, frequency span, and number of analysis lines cannot be changed. Set these parameters before pressing the START/STOP key.

2. Press the START/STOP key.
The “START” message appears.
3. The unit goes into the trigger standby condition, and the ■ symbol flashes on the left side of the display.

Note

To pause the trigger operation, press the PAUSE/CONT key. While the trigger operation is paused, any trigger occurrence will be disregarded. To resume trigger operation, press the PAUSE/CONT key once more.

4. Whenever the trigger condition is met, the display is updated, and the display indication then is held until the next trigger occurrence.
5. When you press the START/STOP key, the “STOP” message appears, and the trigger operation is terminated. The display reverts to the regularly updated condition.

FFT mode (exponential averaging)

The operation principle when using FFT mode (exponential averaging) is illustrated below.

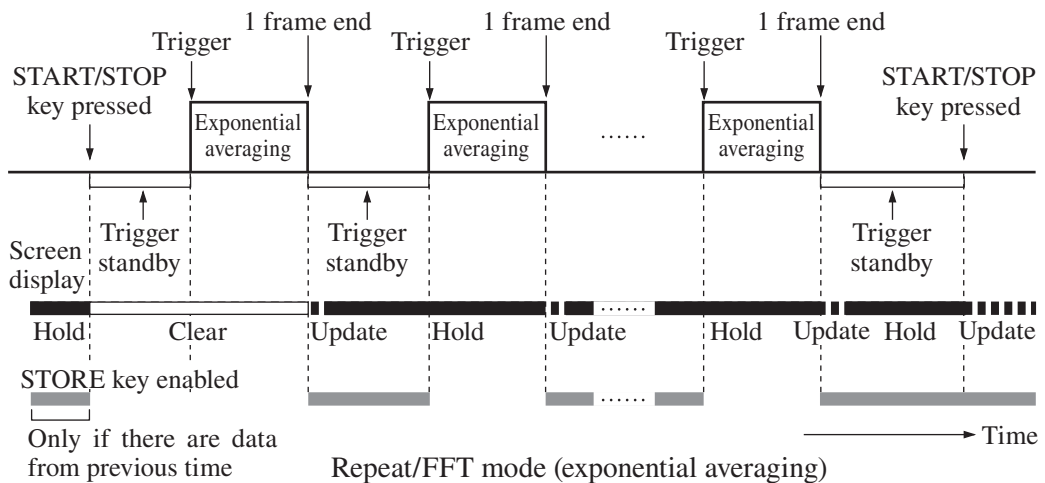

1. Make the required measurement parameter settings.

Note

During the trigger operation, measurement parameters such as the input range, frequency span, and number of analysis lines cannot be changed. Set these parameters before pressing the START/STOP key.

2. Press the START/STOP key. The “START” message appears.
3. The unit goes into the trigger standby condition, and the ■ symbol flashes on the left side of the display.

Note

To pause the trigger operation, press the PAUSE/CONT key. While the trigger operation is paused, any trigger occurrence will be disregarded. To resume trigger operation, press the PAUSE/CONT key once more.

4. Whenever the trigger condition is met, exponential averaging is carried out and the display is updated. The display indication then is held until the next averaging processing is completed.
5. When you press the START/STOP key, the “STOP” message appears, and the trigger operation is terminated. The averaged data at this point are displayed. If there was no trigger occurrence, no averaged data will be displayed when the trigger operation is terminated.

FFT mode (linear averaging, maximum hold)

The operation principle when using FFT mode (linear averaging, maximum hold) is illustrated below.

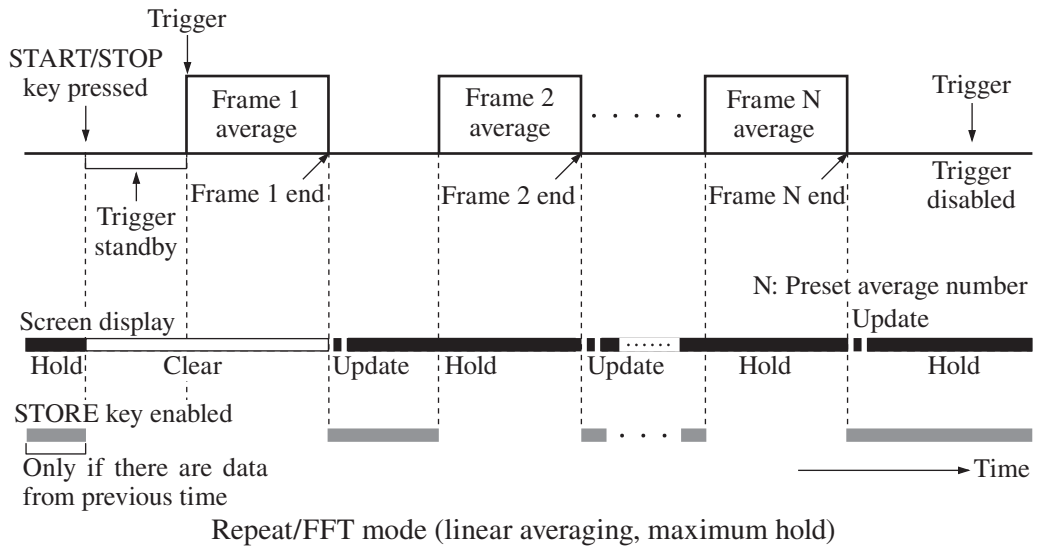

1. Make the required measurement parameter settings.

Note

During the trigger operation, measurement parameters such as the input range, frequency span, and number of analysis lines cannot be changed. Set these parameters before pressing the START/STOP key.

2. Press the START/STOP key. The “START” message appears.
3. The unit goes into the trigger standby condition, and the ■ symbol flashes on the left side of the display.

Note

To pause the trigger operation, press the PAUSE/CONT key. While the trigger operation is paused, any trigger occurrence will be disregarded. To resume trigger operation, press the PAUSE/CONT key once more.

4. Whenever the trigger condition is met, the display is updated. The current averaging count shown on the left side of the display is incremented by one. The display indication then is held until the next averaging processing is completed.

5. When the current averaging count reaches the average number set on the FFT menu screen, the “STOP” message appears, and the trigger operation is terminated. At this point, the linear averaged data or maximum hold data are displayed.

Note
If the START/STOP key is pressed before averaging processing is completed, the trigger operation is terminated. The VA-12 shows the averaged data calculated up to that point.
If there was no trigger occurrence, no averaged data will be displayed when the trigger operation is terminated.

Performing measurement with single trigger

Time waveform mode

The operation principle when using time waveform mode is illustrated below.

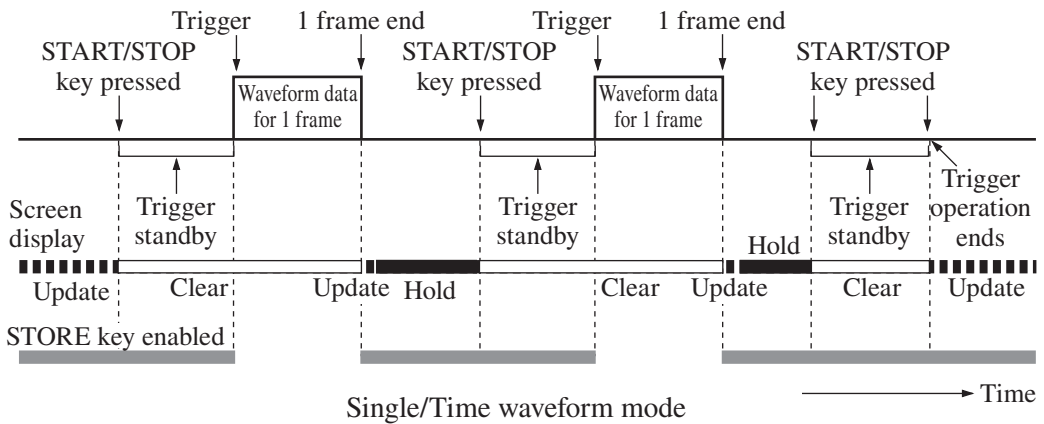

1. Make the required measurement parameter settings.

Note

During the trigger operation, measurement parameters such as the input range, frequency span, and the number of analysis lines cannot be changed. Set these parameters before pressing the START/STOP key.

2. Press the START/STOP key.

The unit goes into the trigger standby condition, and the ■ symbol flashes on the left side of the display.

Note

To pause the trigger operation, press the PAUSE/CONT key. While the trigger operation is paused, any trigger occurrence will be disregarded. To resume trigger operation, press the PAUSE/CONT key once more.

Trigger operation can be terminated by pressing the START/STOP key during trigger standby.

3. When the trigger condition is met, the “START” message appears, and the waveform for one frame is displayed. Next, the “STOP” message is shown. The display indication is held.
4. When you press the START/STOP key, the unit again goes into the trigger standby condition of step 2. If you want the trigger operation to stop at this point, change the trigger operation setting in the [Measure] menu screen to “Free”.

FFT mode (exponential averaging)

The operation principle when using FFT mode (exponential averaging) is illustrated below.

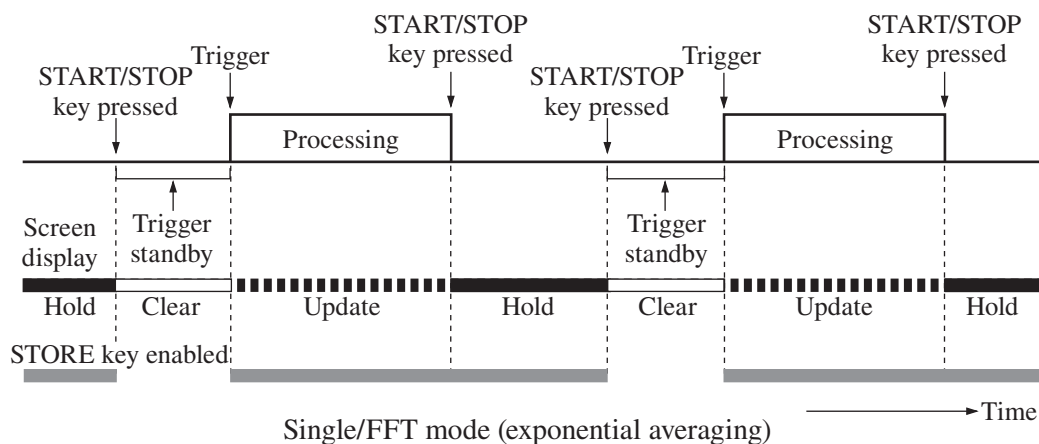

1. Make the required measurement parameter settings.

Note

During the trigger operation, measurement parameters such as the input range, frequency span, and number of analysis lines cannot be changed. Set these parameters before pressing the START/STOP key.

2. Press the START/STOP key.
The unit goes into the trigger standby condition, and the ■ symbol flashes on the left side of the display.

Note

To pause the trigger operation, press the PAUSE/CONT key. While the trigger operation is paused, any trigger occurrence will be disregarded. To resume the trigger operation, press the PAUSE/CONT key once more.

Trigger operation can be terminated by pressing the START/STOP key.
If there was no trigger occurrence, no data will be displayed when the trigger operation is terminated.

3. When the trigger condition is met, the "START" message appears, and exponential averaging is carried out. This continues until the START/STOP key is pressed. When the START/STOP key is pressed, the "STOP" message appears and trigger operation is terminated. The average value display indication at this point is held.
When the START/STOP key is pressed once more, the unit again goes into the trigger standby condition of step 2.

FFT mode (linear averaging, maximum hold)

The operation principle when using FFT mode (linear averaging, maximum hold) is illustrated below.

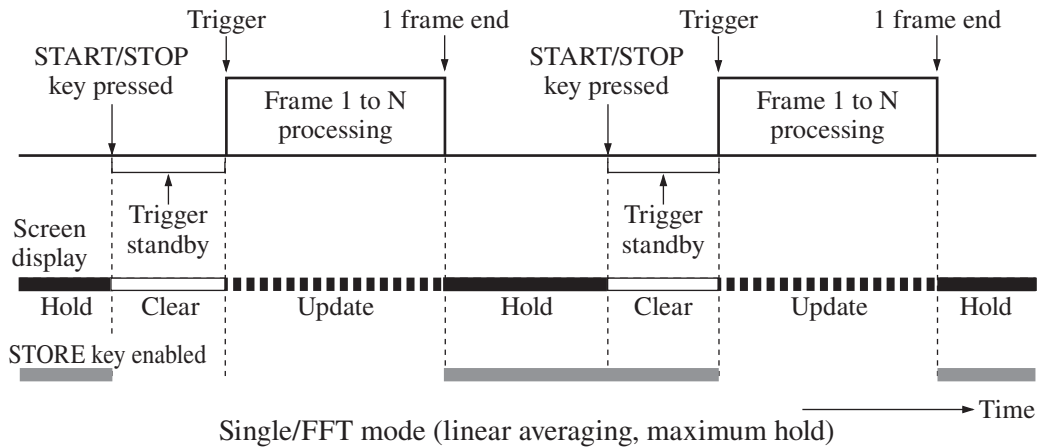

1. Make the required measurement parameter settings.

Note

During the trigger operation, measurement parameters such as the input range, frequency span, and number of analysis lines cannot be changed. Set these parameters before pressing the START/STOP key.

2. Press the START/STOP key. The unit goes into the trigger standby condition, and the ■ symbol flashes on the left side of the display.

Note

To pause the trigger operation, press the PAUSE/CONT key. While the trigger operation is paused, any trigger occurrence will be disregarded. To resume the trigger operation, press the PAUSE/CONT key once more.

Trigger operation can be terminated by pressing the START/STOP key.
If there was no trigger occurrence, no data will be displayed when the trigger operation is terminated.

3. When the trigger condition is met, the “START” message appears, and averaging processing for the specified number of times is carried out. Then the “STOP” message appears and trigger operation is terminated. Pressing the START/STOP key during averaging processing will also terminate the trigger operation.
The average value display indication at the point when trigger operation was terminated is held.

Performing measurement with time trigger

Note
Simply making time trigger settings is not enough to have measurement data automatically stored from the trigger start time. You must also press the STORE key to set the unit to the time trigger standby mode. This will cause measurement data to be stored from the preset trigger start time, for the preset number of times.
During time trigger operation, the STORE key and PAUSE/CONT key are inactive.

Preparation for using time trigger function

To use the time trigger function, perform the following steps first.

1. Verify that the SD card symbol  is shown on the title bar. If no symbol is shown, insert an SD card.
2. Check the store address shown at the right end of the title bar. To prevent overwriting of already stored measurement data, use one of the following two methods.

Method 1

Hold down the \triangle / ∇ keys to find a range of store addresses shown on a white background. When you have found a range that is long enough for continuous storing of the preset number of measurement data, use the \triangle / ∇ keys again to return to the first store address of the range, so that this address is displayed as the store target address for the first measurement data set.

Method 2

Display the [Measure] menu screen and specify a new [Store Name].

Operation when START/STOP key is pressed

The operation, when the START/STOP key is pressed, is as follows.

- If the VA-12 is in vibration meter mode or time waveform mode, the pressing the key has no effect.
- If the VA-12 is in FFT mode, the following applies:
 - If trigger operation is enabled, trigger operation is terminated.
 - If trigger operation is not enabled, the operation is the same as when trigger mode is [Free]. When Instantaneous value or exponential averaging is selected, the display is updated continuously. When linear averaging or maximum hold is selected, averaging is carried out for the preset number of times, and the display is then held.

Vibration meter mode

The operation principle when using vibration meter mode is illustrated below.

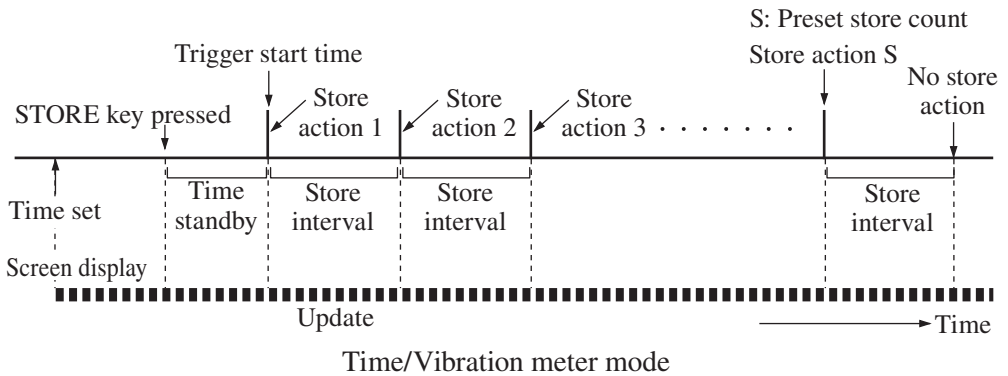

1. Make the required measurement parameter settings.

Note
During trigger operation, the input range setting cannot be changed.

2. Press the STORE key.

The “Waiting for Time Trigger...” popup indication appears, the ■ symbol is flashing, and the LED indicator is flashing in yellow.

Note
The trigger operation cannot be paused.

3. When the trigger start time is reached, the popup indication “STORE XXXX” (where XXXX is the store address) appears, storing is carried out, and the LED indicator flashes in red.

When storing is complete, the store address is incremented by one. If the store address was 1000, the trigger operation is terminated when storing is complete.

4. Subsequently, data are stored at the preset store intervals. The indicator function and popup indication are the same as in step 3.
5. When the preset store number has been reached, the popup indication “Time trigger measurement is completed” is shown, and trigger operation is terminated.

Trigger operation can also be terminated at any previous point by pressing the START/STOP key.

Time waveform mode

The operation principle when using time waveform mode is illustrated below.

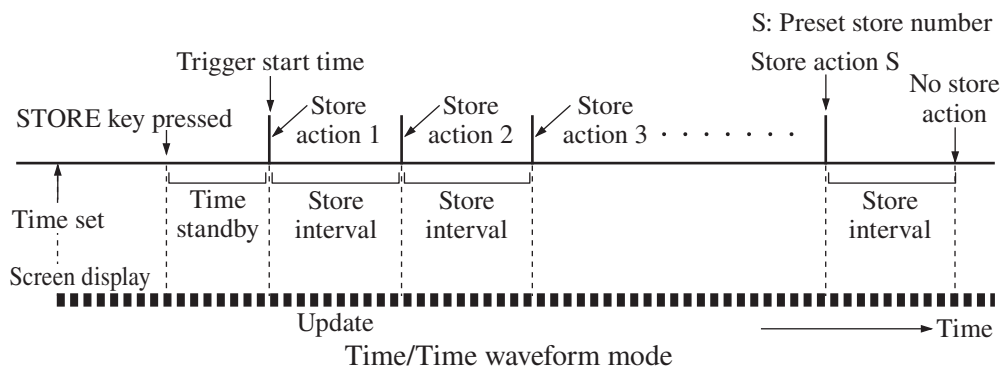

1. Make the required measurement parameter settings.

Note
During the trigger operation, measurement parameters such as the input range, frequency span, and number of analysis lines cannot be changed. Set these parameters before pressing the STORE key.

2. Press the STORE key.

The “Waiting for Time Trigger...” popup indication appears, the ■ symbol is flashing, and the LED indicator is flashing in yellow.

Note
The trigger operation cannot be paused.

3. When the trigger start time is reached, the popup indication “STORE XXXX” (where XXXX is the store address) appears, and the data up to that point are stored.

While storing is carried out, the LED indicator flashes in red. When storing is complete, the store address is incremented by one. If the store address was 1000, the trigger operation is terminated when storing is complete.

4. Subsequently, data are stored at the preset store intervals. The indicator function and popup indication are the same as in step 3.
5. When the preset store number has been reached, the popup indication “Time trigger measurement is completed” is shown, and trigger operation is terminated.

Trigger operation can also be terminated at any previous point by pressing the START/STOP key.

FFT mode (exponential averaging)

The operation principle when using FFT mode (exponential averaging) is illustrated below.

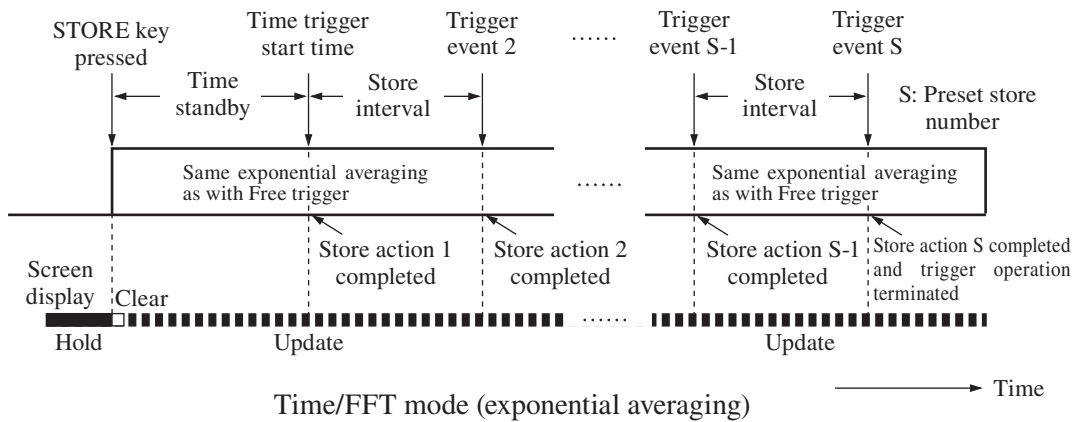

1. Make the required measurement parameter settings.

Note

During the trigger operation, measurement parameters such as the input range, frequency span, and number of analysis lines cannot be changed. Set these parameters before pressing the STORE key.

2. Press the STORE key.

The “Waiting for Time Trigger...” popup indication appears, the ■ symbol is flashing, and the LED indicator is flashing in yellow.

Note

The trigger operation cannot be paused.

3. When the trigger start time is reached, the popup indication “START” appears, and the data averaged up to this point are stored. While storing is carried out, the LED indicator flashes in red.

When storing is complete, the store address is incremented by one. If the store address was 1000, the trigger operation is terminated when storing is complete.

The averaged data are reset, and a new averaging processing cycle starts.

Note

<p>If the waveform recording function is set to [On], waveform data will also be stored at this point. During processing, the waveform recording in the progress indicator REC. is flashing in the top section of the graph. For details on the waveform recording function, see the “Recording Waveform Data” section.</p>
--

4. Subsequently, averaged data are stored at the preset store intervals.
5. When the preset store number has been reached, the popup indication “Time trigger measurement is completed” is shown, and trigger operation is terminated.

Trigger operation can also be terminated at any previous point by pressing the START/STOP key.

FFT mode (linear averaging, maximum hold)

The operation principle when using FFT mode (linear averaging, maximum hold) is illustrated below.

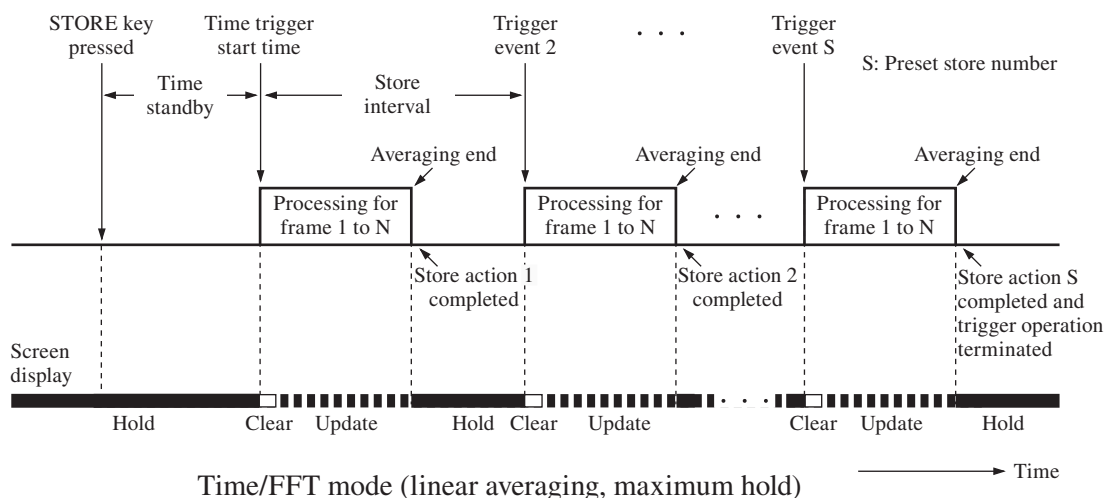

1. Make the required measurement parameter settings.

Note

<p>During the trigger operation, measurement parameters such as the input range, frequency span, and number of analysis lines cannot be changed. Set these parameters before pressing the STORE key.</p>
--

2. Press the STORE key.

The “Waiting for Time Trigger...” popup indication appears, the ■ symbol is flashing, and the LED indicator is flashing in yellow.

Note
The trigger operation cannot be paused.

3. When the trigger start time is reached, the popup indication “START” appears, and the data averaged up to this point are stored. While string is carried out, the LED indicator flashes in red.

When storing is complete, the store address is incremented by one. If the store address was 1000, the trigger operation is terminated when storing is complete.

The averaged data are reset, and a new averaging processing cycle starts.

Note
If the waveform recording function is set to [ON], waveform data will also be stored at this point. During processing, the waveform recording in the progress indicator REC. is flashing in the top section of the graph. For details on the waveform recording function, see the “Recording Waveform Data” section.

4. Subsequently, averaged data are stored at the preset store intervals.
5. When the preset store number has been reached, the popup indication “Time trigger measurement is completed” is shown, and trigger operation is terminated.

Trigger operation can also be terminated at any previous point by pressing the START/STOP key.

Overlay Display

In FFT mode (graph display), the screen for displaying stored data can be shown together with the current measurement screen in an overlay configuration. This makes a comparison of data easier.

Activating the overlay display

1. At the [Display] menu screen, set the [Overlapping] item to [On].
2. At the measurement screen, store the data that you want to use for the overlay display (see page 75).
3. Recall the data stored in step 2 (see pages 79 to 80).
4. Press the STORE key.
The background of the store address indication becomes orange, and the overlay symbol  is shown on the status bar. The LED indicator flashes in green.
5. Press the START/STOP key to return to the measurement screen.
The stored data and the current data are now shown together in an overlay configuration. Both the line chart and bar graph for the stored data are shown in green.

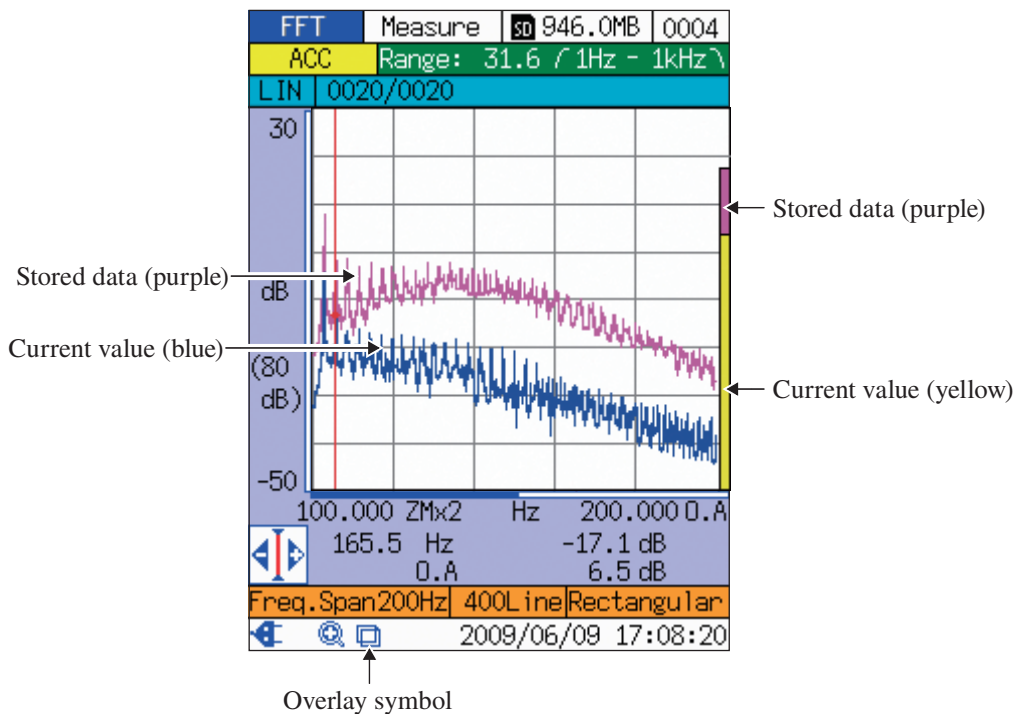

Overlay display example

Note
If stored data are not shown, set the [Overlapping] item in the [Display] menu screen to [On].
Overlay display is only possible if the following measurement parameters are identical for the recalled data and measurement data: analysis mode, measurement data type, frequency span, and number of analysis lines.
When not carrying out step 2 immediately after step 1, saving the settings immediately after step 1 is recommended, to eliminate the need for setting all of the above parameters again. The saved settings can then be loaded before carrying out step 2. For details on saving and loading settings, see “Using setup files” (page 113).

Canceling the overlay display

1. At the [Display] menu screen, select the [Overlapping] item.
2. To simply turn the overlay off, select the [Off] setting. To completely cancel the overlay data, select the [Clear] setting.

Note
Pressing the STORE key at the recall screen has the same effect as selecting the [Clear] setting.

Reactivating the overlay display

If overlay display was simply set to [Off] in step 2, the display can be reactivated as follows.

1. At the [Display] menu screen, select the [Overlapping] item.
2. Select the [On] setting.

Setup Files and Initialization

Resume function

When power to the VA-12 is turned on, the measurement screen appears. The settings active at this point are the same as were selected before the unit was last turned off (resume function).

For details on settings covered by the resume function, see the “Setting items” section on page 117. The store address indication and measurement data of FFT mode are not included in the resume function.

Note
When power to the VA-12 is turned on while an SD card is inserted in the unit, and if one or more setup files are present on the card, the setup file load function (see below) will take precedence over the resume function.

Loading a setup file at startup

When power to the VA-12 is turned on while an SD card is present, containing one or more setup files (a special type of file in a specified folder: SETUP folder of folder structure on page 126), a dialog window asking the user whether to load stored settings appears.

Selecting [Yes] at this dialog window will load the settings stored in the selected file (setup file load function).

Selecting [No] at this dialog window will cause the resume function to re-establish the same settings as before the last time the unit was turned off. For details about utilizing setup files at startup, see the “Using setup files” section on page 113.

Initialization

Settings of the VA-12 can be initialized (reset to the default condition) using one of the following methods:

- Keep the START/STOP key depressed while pressing the POWER key to turn the unit on.
- Use the [System/Setting] screen (See “Note” in the “Loading a setup file” section on page 114.)

For information on items that will be reset, see the “Setting items” section on page 117.

Using setup files

Setup files enable the following functions.

- Establish settings quickly and precisely by loading from a file prepared beforehand and stored on an SD card
- Return settings that were accidentally changed to the previous condition by loading from a file stored on an SD card

The VA-12 allows you to store up to five different sets of settings (see the section starting on next page). By using SD cards, you can create multiple groups of setup files stored in separate folders (see illustration below and explanation on page 126).

This makes it possible to have groups of settings optimized for various applications and load them as needed.

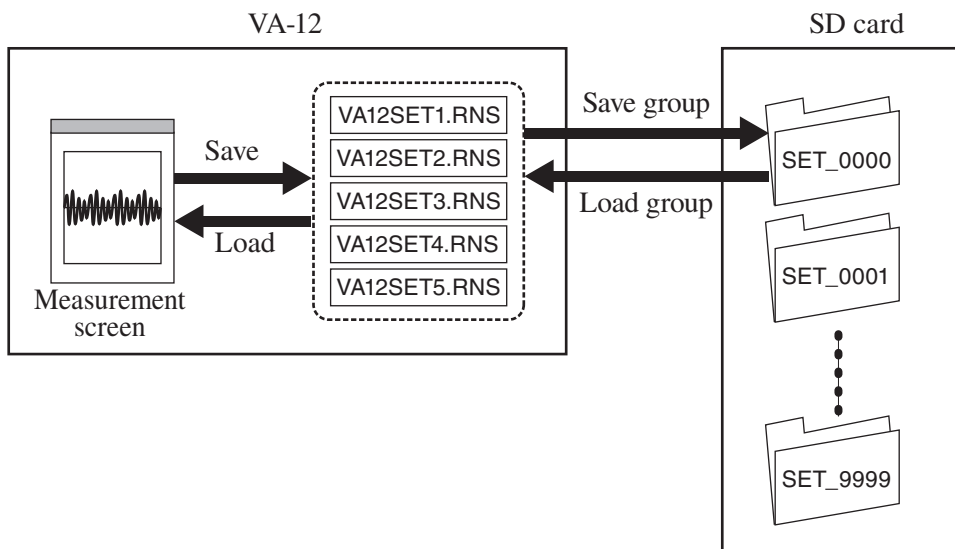

Saving the current settings

To save the current settings, proceed as follows.

1. At the [SYSTEM] menu screen, select [Read/Save Setting] and press the ENT key. The [System/Setting] screen comes up.
2. Select the desired number and press the STORE key. The current settings of the VA-12 are saved in the selected number.

Note
The recall screen settings are not saved. Only the settings of the immediately preceding measurement screen will be saved.

Loading a setup file

Note
When you load settings from a file, the current settings will be overwritten. If necessary, you should save the current settings before loading a new set of settings.

1. At the [SYSTEM] menu screen, select [Read/Save Setting] and press the ENT key. The [System/Setting] screen comes up.
2. Select the desired number and press the ENT key. The settings saved in the selected number are loaded.

Note
When you select [Load Default] and press the ENT key, the settings are initialized (returned to the default condition).

Deleting a setup file

1. At the [SYSTEM] menu screen, select [Read/Save Setting] and press the ENT key. The [System/Setting] screen comes up.
2. Select the desired number and press the PAUSE/CONT key. The setup file is deleted.

Saving settings on SD card as a group

To save five sets of settings (setup files) of the VA-12 as a group on an SD card, proceed as follows.

1. At the [SYSTEM] menu screen, select [Read/Save Setting] and press the ENT key. The [System/Setting] screen comes up.
2. Select [Group Save for SD] and press the ENT key. The [SYSTEM/Setting] screen comes up.
3. Select [----- (New File) -----].
4. Specify the settings group name (SET_0000 to SET_9999) and press the ENT key.

Loading a setup file group from SD card

Note
When a group of setup files is loaded, setup files in the VA-12 will be overwritten. If necessary, you should save the current setup files on the SD card before loading a new group of files.

1. At the [SYSTEM] menu screen, select [Read/Save Setting] and press the ENT key. The [System/Setting] screen comes up.
2. Select [Group Load/Delete for SD] and press the ENT key. The [SYSTEM/Settings/SD read] screen comes up.
3. Select the group to load and press the ENT key.

Deleting a setup file group from SD card

1. At the [SYSTEM] menu screen, select [Read/Save Setting] and press the ENT key. The [System/Setting] screen comes up.
2. Select [Group Load/Delete for SD] and press the ENT key. The [SYSTEM/Settings/SD read] screen comes up.
3. Select the group to delete and press the PAUSE/CONT key.

Setup file content example

A setup file contains a list of setting commands and setting values. The file is a CSV (Comma Separated Values) format text file. An example is shown below.

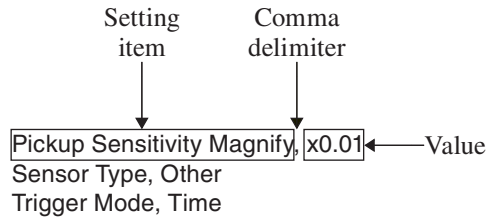

Setup file content (example)

For details on the setting commands, see the “Setting Commands” section.

Setting items

Setting items that are covered by the resume and initialization functions along with their default values are listed in the table below.

*: Items stored in setup files

	Setting item	Setting command	Default value
System	Backlight brightness	Brightness	Dark
	Backlight auto off	Backlight Auto Off	30 s
	* Beep	Beep	Off
	Display language	Language	English
Measurement	* Store name	Store Name	MAN_0000
	* Trigger mode	Trigger Mode	Free
	* Waveform recording	Wave Recording	OFF
	* Trigger source	Trigger Source	Level trigger
	* Pretrigger	Pretrigger	OFF
	* Trigger level	Trigger Level	1/8
	* Trigger slope	Trigger Slope	+
	* Trigger start time	Start Time	2010/01/01 00:00:00 (YYYY/MM/DD hh:mm:ss)
	* Store interval	Store Interval	1 minute
	* Store number	Store Number	1
	* Frequency span	Frequency Span	5 kHz
	* Number of analysis lines	Analysis Line	400
	* Average number	Average Count	1
	* Analysis mode	Analysis Mode	Vibration meter
* Measurement data type	Data Type	Acceleration	
* Input range	Level Range	“2” (actual value depends on screen)	

	Setting item	Setting command	Default value
Display (menu setting)	* Vibration meter graph X axis scale	Scale VM	Linear
	* FFT graph Y axis scale	Scale Unit FFT Y	Linear
	* FFT cursor X axis unit	Cursor Unit FFT X	Hz
	* FFT cursor Y axis unit	Cursor Unit FFT Y	Linear
	* Level list display	List Display	Off
	* Time display	Time Display	On
	* Overlay display	Layer Display	Off
Analog Input	* High-pass filter	High Pass Filter	3 Hz
	* Low-pass filter	Low Pass Filter	5 kHz
	* Sensor selection	Sensor Type	PV-57I
	* Accelerometer sensitivity (numeral)	Pickup Sensitivity Num	510
	* Accelerometer sensitivity (factor)	Pickup Sensitivity Magnify	0.1
FFT	* Time window function	Window Function	Hanning
	* Averaging display	Average Disp	Instantaneous value
	* Operation type	Average Type	Linear
Display (key setting)	* FFT X axis zoom	FFT Expand X	×1
	* FFT Y axis zoom (Log)	FFT Expand Y Log	80
	* FFT Y axis zoom (Lin)	FFT Expand Y LIN	0
	* Time waveform X axis zoom	TIME Expand X	×1
	* Time waveform Y axis zoom	TIME Expand Y	0
	* X axis upper limit (line position)	X Upper	200
	* X axis lower limit (line position)	X Lower	0
	* FFT cursor position (line position)	Cursor Position FFT	0
	* FFT (list) cursor position	Cursor Position LIST	0
	* Time waveform cursor position	Cursor Position Time	0
	* Zoom on/off	Zoom Mode	Off
	* Zoom/Move mode	Zoom Move	Zoom mode
	Store address	Store Address	0001

Power Supply

Battery-powered operation and external power supply operation

The VA-12 can be powered by batteries or an external power supply (AC adapter) connected to the unit.

When both types of power sources are present, the external power supply has priority.

AC adapter	Batteries	Unit powered by
Present	Present	AC adapter
Present	Not present	AC adapter
Not present	Present	Batteries

Batteries

Battery life

The unit uses IEC R6 (size AA) batteries.

Actual battery life will depend on environmental and usage factors and on the battery brand. Approximate figures are given below.



Battery life (at 23°C)	Alkaline batteries	LR6	12 hours
	Manganese batteries	R6PU	3 hours

With alkaline batteries LR6, keeping the display backlight on will result in a battery life of about 10 hours.

When to replace the batteries

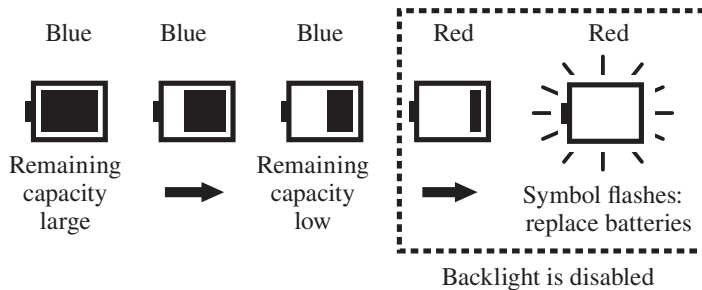
During battery-powered operation, the battery capacity symbol is shown on the status bar, as illustrated below. The blue section of the symbol becomes gradually smaller as the batteries are used up. When the indicator starts to flash, correct measurement is no longer possible. Replace the batteries with a new set.



Note
While the battery capacity symbol is  or  , the display backlight will not turn on.

External power supply (AC adapter)

To power the VA-12 from an external source, be sure to use the optional AC adapter NC-99 series.

Important
Do not use an adapter other than the NC-99 series to prevent the risk of damage.

While the unit is powered from an external source, the AC adapter symbol  is shown.

Auto shut-off function

When the battery capacity symbol  has started to flash in red, a message will be displayed, and the VA-12 will turn itself off automatically after 30 seconds.

Important
If a power failure occurs while the VA-12 is powered from the AC adapter, operation will automatically switch to battery power if batteries are inserted, allowing the unit to continue functioning. If no batteries are inserted, the unit will turn off.

Using the Backlight

The VA-12 is equipped with a display backlight that enables easy measurement also in dark locations. To use the backlight, proceed as follows.

Selecting the backlight brightness

1. At the [SYSTEM] menu screen, select [Backlight Brightness].
2. Select [Dark] or [Bright].

Selecting the backlight auto-off delay

Using the backlight requires power and therefore results in shorter battery life (see page 119).

You can select the delay until the backlight is turned off automatically.

1. At the [SYSTEM] menu screen, select [Backlight Auto-Off].
2. Select [30s], [3min], or [Cont.].

Note
The [30s] or [3min] setting is recommended to conserve battery power.

Using the backlight

Press the LIGHT key to turn the backlight on.















Each push of the key toggles the backlight between on and off.

Note
While the battery capacity symbol on the status bar is  or  , the backlight will not turn on.

Status Display

Symbol List

The following symbols may appear on the display of the VA-12.

Symbol	Color	Name	Location	Meaning
	Blue	Remaining battery capacity (1)	Status bar	Battery-powered operation possible
	Blue	Remaining battery capacity (2)	Status bar	
	Blue	Remaining battery capacity (3)	Status bar	
	Red	Remaining battery capacity (4)	Status bar	Replace batteries. The display backlight does not light.
	Red	Remaining battery capacity (5)	Status bar	
	Blue	AC adapter	Status bar	Unit is powered from external power supply (AC adapter)
	Black	SD card	Title bar	Permanently on when SD card is inserted. Flashing when card is being checked.
	Yellow	Key lock	Status bar	Operation keys are locked
	Two-color	Graph zoom	Bottom left of graph	Display scaling/zoom mode
	Two-color	Cursor move	Bottom left of graph	Display scaling/move mode
	Blue	Magnifying glass	Status bar	Display scaling mode
	Blue	Overlay	Status bar	Overlay display of data is enabled
	Yellow	WAVE file	Recall list	Folder contains WAVE files
	Yellow	Waveform recording	Status bar	Waveform recording function is enabled
	Yellow	Waveform recording in progress	Top section of graph	Waveform recording function is enabled and in progress

LED Indicator

Lighting patterns for status indication

Status	Color	Pattern	Status symbol
Startup	Red → Yellow → Green → Light Blue → Blue → Purple	Lit	—
Processing	Green	Flashing	▶
Pause	Blue	Flashing	▬▬
Overload	Red	Lit	—
Single trigger standby	Yellow	Sequence of 2 flashes	■
Repeat trigger standby	Yellow	Sequence of 2 flashes	■
Time trigger standby	Yellow	Sequence of 2 flashes at longer intervals	■
Shutdown processing	—	Blue → Off → Green → Off → Red → Off	—

Lighting patterns for operation indication

Operation	Color	Pattern
STORE key pressed (trigger operation mode other than [Time])	Red	Rapid flashing during data store. 3 flashes when complete.
STORE key pressed (trigger operation mode is [Time])	Yellow	2 flashes
Time trigger activated data storing	Red	Rapid flashing during data store. 3 flashes when complete.
Processing complete	Green	3 flashes
Data store on SD card	Red	Rapid flashing during data store. 3 flashes when complete.
Data load from SD card	Red	Rapid flashing during data load. 3 flashes when complete.

Note

Operation indication has priority over status indication.

SD Card

Important

Always turn the power to the VA-12 off before removing the SD card. If the SD card is removed while power is on, data may be lost.

SD card data capacity

SD cards with a capacity of up to 2 GB can be used in the VA-12.

Formatting an SD card

Note

When an SD card is formatted (initialized), all data present on the card will be lost.

In the following cases, you should format the SD card:

- Before using the SD card in the VA-12 for the first time
- If the VA-12 does not seem to recognize an inserted SD card
- When wishing to delete all data from the SD card

To format an SD card, proceed as follows.

1. At the [SYSTEM] menu screen, select [SD Card Format].
2. Select [Exec].

However, if the SD card is not recognized by the VA-12, select [Full].

Note	
When [Full] is selected, the card will be formatted to the following specifications.	
Partition	1 fixed partition
Partition size	Entire card capacity
File system	FAT12, FAT16, or FAT32 (depending on size)
Boot code	None
If the SD card is logically corrupt (because power was turned off during a data save operation or similar), format the card in a computer. In that case, select FAT, FAT12, FAT16, or FAT32 as the file system.	

Data transfer

To transfer data stored by the VA-12 on an SD card to a computer, the following two methods can be used.

- Remove the SD card from the VA-12 and insert it into a suitable slot or card reader on the computer to read the data off the card.
- Connect the VA-12 to the computer with a USB cable. The SD card in the VA-12 should be recognized as a removable disk by the computer.

The latter method allows access to VA-12 data on the card even from computers that have no suitable slot or card reader for SD cards.

Folder structure

The diagram below illustrates the data folder structure on the SD card. Use this as a reference when accessing data on a computer or when deleting specific folders and files.

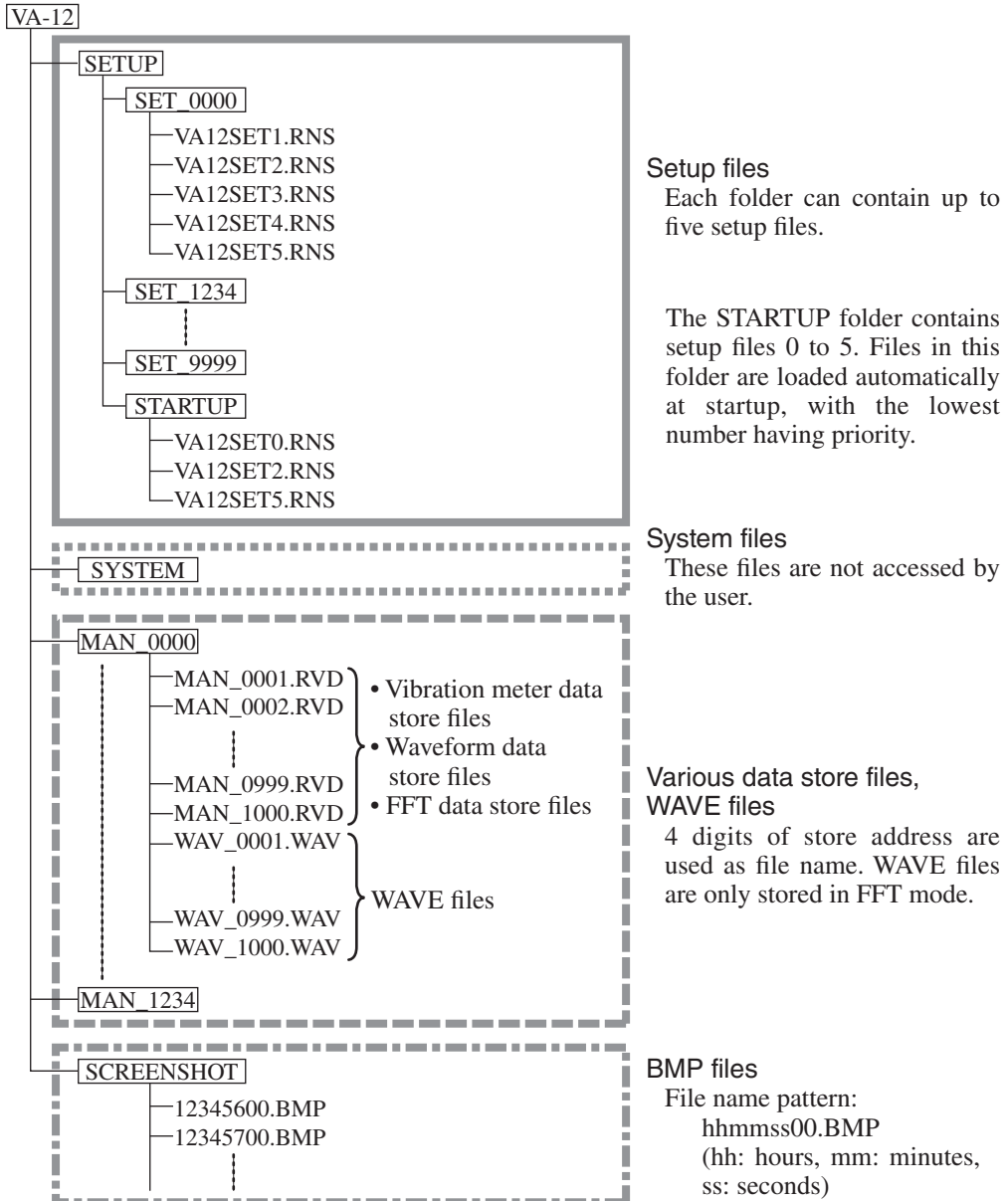

Data File Structure

This section explains the structure of the files used to store measurement data on the SD card.

The following four types of files are used.

- Vibration meter data store file
This type of file is stored when the VA-12 is in vibration meter mode.
- Waveform data store file
This type of file is stored when the VA-12 is in time waveform mode.
- FFT data store file
This type of file is stored when the VA-12 is in FFT mode.
- WAVE file
This type of file is stored along with the FFT data store file when the VA-12 is in FFT mode and the waveform recording function is enabled. (See the “Recording Waveform Data” section.)

Data store files

This section explains vibration meter data store files, waveform data store files, and FFT data store files.

The file name extension of data files stored on SD card is “RVD”. By changing the extension to “CSV”, it is possible to open the files in Microsoft Excel.

File name: MAN_(store address).RVD

File format: CSV (ASCII code)

File structure

The structure of vibration meter data store files, waveform data store files, and FFT data store files is as follows. (“_” indicates a space.)

Root block	Sub block	Block member	Remarks
[Setting]	[VA-12]	Analysis_Mode	Common to all files
		Data_Type	
		Overload_Current	
		(Skipped)	
		Store_Address	
		Store_Number	
		Store_Interval	
		Store_Start_Time	
[Data]	—	Frequency	
		____0.000	
		____0.625	
		____1.250	
		(Skipped)	
		__499.375	
		__500.000	
		_____O.A.	

Setting section

The Setting section is common to all files.

The data content is as follows.

- Item order is as shown in the table, with CR+LF used as a delimiter.
- Each item consists of the following parts: “(header string),_(content) (CR+LF)”. (“_” indicates a space.)
- The “_” in the header string column and content column indicates a space.

Item	Header string	Bytes	Content	Bytes	Description
Block label	(None)		[Setting]	9	Indicates beginning of [Setting] block.
Block label	(None)		[VA-12]	7	Indicates beginning of [VA-12] block.
Analysis mode	Analysis_Mode	13	VM, TIME, FFT, LIST	2 to 4	
Measurement data type	Data_Type	9	Acceleration, Velocity, Displacement, Acc. Envelope	8 to 13	
Overload	Overload_Current	16	Off, On	2 to 3	
Overload (acceleration)	Overload_Current_ACC	20	Off, On	2 to 3	
Overload (velocity)	Overload_Current_VEL	20	Off, On	2 to 3	
Overload (displacement)	Overload_Current_DISP	21	Off, On	2 to 3	
Processing overload	Overload_Result	15	Off, On	2 to 3	
Processing overload (acceleration)	Overload_Result_ACC	19	Off, On	2 to 3	
Processing overload (velocity)	Overload_Result_VEL	19	Off, On	2 to 3	
Processing overload (displacement)	Overload_Result_DISP	20	Off, On	2 to 3	
High-pass filter	High_Pass_Filter	16	1Hz, 3Hz, 10Hz, 1kHz	3 to 4	
Low-pass filter	Low_Pass_Filter	15	1kHz, 5kHz, 20kHz	4 to 5	
Input range	Level_Range	11	0, 1, 2, 3, 4, 5, 6	1	0 is the lowest range setting, then 1, 2, etc.
Frequency span	Frequency_Span	14	100Hz, 200Hz, 500Hz, 1kHz, 2kHz, 5kHz, 10kHz, 20kHz	4 to 5	

Item	Header string	Bytes	Content	Bytes	Description
Number of analysis line	Analysis_Line	13	200, 400, 800, 1600, 3200	3 to 4	
Average display	Average_Dis	12	Lp, Ave	2 to 3	
Operation type	Average_Type	12	Linear, Exp, Max	6	
Average number	Average_Count	13	1 to 2048	1 to 4	
Current completed averaging count	Average_Complete	16	1 to 9999	1 to 4	
Time window function	Window_Function	15	Rectangular, Hanning, Flattop	7 to 11	
Accelerometer sensitivity (numeral)	Actual_Sensitivity_Num	22	100 to 999	3	
Accelerometer sensitivity (factor)	Actual_Sensitivity_Magnify	26	×0.1, ×0.01, ×0.001	4 to 6	
Sensor selection	Sensor_Type	11	PV-57I, Other	5 to 6	
Measurement start time	Start_Time	10	YYYY/MM/DD_hh:mm:ss	19	
Trigger mode	Trigger_Mode	12	Free, Repeat, Single, Time	4 to 6	
Trigger source	Trigger_Source	14	Level Trigger, External Trigger	13 to 16	
Trigger level	Trigger_Level	13	-7 to +7	2	
Trigger slope	Trigger_Slope	13	-, +	1	
Pretrigger	Pretrigger	10	OFF, ON	4 to 10	
Store name	Store_Name	10	0 to 9999	1 to 4	
Store address	Store_Address	13	1 to 1000	1 to 4	
Store number	Store_Number	12	1 to 1000	1 to 4	
Store interval	Store_Interval	14	1 min, 5 min, 10 min, 30 min, 60 min	4 to 5	
Timer store start time	Store_Start_Time	16	YYYY/MM/DD_hh:mm:ss	19	

Data section (vibration meter data store file)

In the case of a vibration meter data store file, the data section has the following content.

Item	Header string	Bytes	Content	Bytes
Block label	(None)	—	[Data]	6
Acceleration rms value	ACC_	4	_xxxx.y,_zzzzzz	15
Acceleration peak value	PEAK	4	• xxxx.y is calculated value (Log)	15
Acceleration peak crest factor	C.F.	4	Padded with spaces (“_”) to 6 digits	15
Velocity rms value	VEL_	4	• zzzzzz is calculated value (Linear)	15
Displacement equivalent p-p value	DISP	4	Padded with spaces (“_”) to 7 digits	15

An example is shown below. From the left, the values indicate measurement data type, calculated value (Log), and calculated value (Linear). The units are the same as those that were shown during measurement.

Measurement data type	Calculated value (Log)	Calculated value (Linear)
[Data]		
ACC ,	17.4,	7.5
PEAK,	29.1,	28.6
C. F. ,	1.6,	3.84
VEL ,	14.8,	5.5
DISP,	-13.4,	0.21

Data section (waveform data store file)

In the case of a waveform data store file, the entire waveform data for one interval section are listed, using 1 line per data.

Item	Header string	Bytes	Content	Bytes
Block label	(None)	—	[Data]	6
Waveform data	(None)	—	xxx.yyyy	17 or more
:	:	:	• Maximum display is 5 digits	:
:	:	:		:
:	:	:		:
Waveform data	(None)	—		17 or more

An example is shown below.

[Data]
100.21
-100.21
21.589
-38.721
1.0014
-0.0012

Data section (FFT data store file)

In the case of an FFT data store file, the data section has the following content.

Item	Header string	Bytes	Content	Bytes
Block label	(None)	—	[Data]	6
Title	Frequency	9	INST, LIN, EXP, MAX	4
Frequency *	_____0 _____0.0 __0.00000 etc.	9	xxxxxx,_yyyyyy • xxxxxx is calculated value (Log) Padded with spaces (“_”) to 6 digits • yyyyyy is calculated value (EU) Padded with spaces (“_”) to 7 digits	15
:	:	:		:
:	:	:		:
:	:	:		:
Overall value	_____O.A.	9		15

* Frequencies are given in ascending order

Number of digits after decimal point differs depending on file; range: 0 to 5.

An example is shown below. From left, the values indicate frequency, calculated value (Log), and calculated value (EU = Engineering Units). The units are the same as those that were shown during measurement.

	Frequency	Calculated value (Log)	Calculated value (EU)
[Data]	Frequency	INST	
	0	37.1	7.13E+01
	12.5	31.7	3.86E+01
	25	13.3	4.64E+00
	37.5	-0.2	9.78E-01
	50	-9.7	3.29E-01
	62.5	-17.3	1.37E-01
	75	-20.5	9.41E-02
	87.5	-23.8	6.44E-02
	100	-29.1	3.52E-02
	112.5	-33.2	2.19E-02
	125	-33.7	2.07E-02
	137.5	-35.8	1.63E-02
	150	-40.1	9.91E-03
	162.5	-42.6	7.43E-03

WAVE files

This section explains WAVE files.

File name: WAV_(store address).WAV

File format: RIFF

File structure

WAVE files employ a format called RIFF which encodes information in multiple chunks that are linked and saved as a file.

Identifier: "RIFF"		4 bytes		
Size: n+4		4 bytes		
Data	Form type	4 bytes	n bytes	
	Sub chunk			} Chunk
	Identifier	4 bytes		
	Size	4 bytes		
	Data	4 bytes		
	Sub chunk			} Chunk
	Identifier	4 bytes		
	Size	4 bytes		
	Data	4 bytes		
	:			
	:			
	:			
	Sub chunk			} Chunk
	Identifier	4 bytes		
Size	4 bytes			
Data	4 bytes			

The chunk configuration used by the VA-12 is as follows.

RIFF chunk: This is always located at the beginning of the WAVE file and is called the RIFFHeader. This chunk comprises the following five sub chunk types.

fmt sub chunk: Data attributes (data format, sampling frequency, etc.)

Rion sub chunk: VA-12 specific information (processing parameters etc.)

data sub chunk: Waveform data

memo sub chunk:

VA-12 specific information (expanded area)

paus sub chunk: VA-12 specific information (expanded area)

The configuration of each (sub) chunk is explained below.

The variable types used in the table are as follows.

WORD: 16-bit unsigned integer

DWORD: 32-bit unsigned integer

double: IEEE double-precision floating

char: Character string

RIFF chunk

Variable name	Bytes	Type	Content
groupID	4	char	“RIFF”
chunkSize	4	DWORD	Chunk size (in bytes)
riffType	4	char	“WAVE”

fmt sub chunk

Variable name	Bytes	Type	Content
chunkID	4	char	“fmt”
chunkSize	4	DWORD	Chunk size (in bytes): 16
nFormatTag	2	WORD	Format type: 0x0001
nChannels	2	WORD	Number of channels: 1
nSamplesPerSec	4	DWORD	Number of samples per second
nAvgBytesPerSec	4	DWORD	Number of bytes per second (all channels) *
nBlockAlign	2	WORD	Block size: 8
wBitsPerSample	2	WORD	Number of bits per sample: 16

* $nAvgBytesPerSec = nSamplesPerSec \times nChannels \times wBitsPerSample / 8$

Rion sub chunk (VA-12 specific)

Variable name	Bytes	Type	Content
chunkID	4	char	“rion”
chunkSize	4	DWORD	Chunk size (number of bytes): 460
RIONFORMAT	460	Constituent	Processing parameters and other information of VA-12 (see next page)

data sub chunk

Variable name	Bytes	Type	Content
chunkID	4	char	“data”
chunkSize	4	DWORD	Waveform data size (number of bytes)
DATA	n	Constituent	Waveform data

WAVE file data of VA-12 are fixed to 16 bit.

sample1	sample2	sample3	sample4
Data	Data	Data	Data

Contents of RIONFORMAT

("_" indicates a space)

Order	Variable name	Bytes	Type	Content
000	nMaker	4	DWORD	Manufacturer name: "RION"
004	ProductType	8	char	Model: "VA-12____"
012	nId	4	DWORD	Device ID: 0
016	nFileVersion	4	DWORD	File version: 1 or more
020	nCpuVersion	8	char	CPU version: x.x.xxx_
028	nDspVersion	8	char	DSP version: y.y.yyy_
036	Ch1ValuePerBit	8	double	Calibration value per bit 0 if not used
044	Reserved	8	double	0
052	Reserved	8	double	0
060	Reserved	8	double	0
068	Ch1ValuePerVolt	8	double	Voltage and display conversion 0: Not used, 1: No conversion
076	Reserved	8	double	0
084	Reserved	8	double	0
092	Reserved	8	double	0
100	Ch1Unit	8	char	Left-justified indication of measurement unit Padded with "_" (space) "m/s2____", "m/s____", "mm____"
108	Reserved	8	char	Space
116	Reserved	8	char	Space
124	Reserved	8	char	Space
132	Ch1InputRange	8	char	Left-justified indication of input range Padded with "_" (space) "1m/s2____", "31.6mm____" etc.
140	Reserved	8	char	Space
148	Reserved	8	char	Space
156	Reserved	8	char	Space
164	dwCh1LowPassFilter	4	DWORD	Low-pass filter 0: OFF, 10: 1 kHz, 12: 5 kHz, 20: 20 kHz
168	Reserved	4	DWORD	0
172	Reserved	4	DWORD	0
176	Reserved	4	DWORD	0

Order	Variable name	Bytes	Type	Content
180	dwCh1HighPassFilter	4	DWORD	High-pass filter 0: OFF, 11: 1 Hz, 12: 3 Hz, 15: 10 Hz, 50: 1 kHz
184	Reserved	4	DWORD	0
188	Reserved	4	DWORD	0
192	Reserved	4	DWORD	0
196	dwTriggerType	4	DWORD	Trigger type 0: Free, 10: Level, 20: Time, 30: Ext.
200	dwTriggerMode	4	DWORD	Trigger mode 0: Not used, 10: Free, 20: Single, 30: Repeat
204	dwTriggerSlope	4	DWORD	0: +, 1: -
208	dwTriggerChannel	4	DWORD	Trigger channel: 1
212	TriggerLevel	8	double	Trigger level: unit is % *
220	dwPreTrigger	4	DWORD	Pretrigger 0: OFF, 1: ON
224	Reserved	4	DWORD	0
228	StartTime	16	char	Start time: YYYYMMDD_hhmmss0 One “_” (space) between D and h Example: 2009/6/28, 8:30 is expressed as “20090628_0830000” For the trigger, the start time is defined as including pretime
244	nCh1OverloadInfo	2	WORD	Overload information 0: No overload, 1: Overload occurred at least once during processing
246	Reserved	2	WORD	0
248	Reserved	2	WORD	0
250	Reserved	2	WORD	0
252	Reserved	32	char	Undetermined
284	Reserved	32	char	Undetermined
316	Reserved	32	char	Undetermined
348	Reserved	32	char	Undetermined
380	dwPause	4	DWORD	Number of pauses during processing: 0 or more
384	Reserved	4	DWORD	0
388	nCh1CCLD	2	WORD	CCLD information: always 1
390	Reserved	2	WORD	0
392	Reserved	2	WORD	0
394	Reserved	2	WORD	0

Order	Variable name	Bytes	Type	Content
396	Reserved	8	double	0
404	Reserved	8	double	0
412	Reserved	8	double	0
420	Reserved	8	double	0
428	Reserved	2	WORD	0
430	Reserved	4	DWORD	0
434	dwSerialNr	4	DWORD	Serial number: 0 to $2^{32}-1$
438	Reserved	2	WORD	0
440	Reserved	2	WORD	0
442	dummy	18	Undetermined	Used to delimit header section at 512 bytes

* Example for 1/8: $1 / 8 = 12.5\%$

memo sub chunk (fixed to 40 kB, VA-12 specific)

Variable name	Bytes	Type	Content
chunkID	4	char	“memo”
chunkSize	4	DWORD	Chunk size (in bytes): 40944
MEMORECTIMEFORMAT	40944	Constituent	Reserved
dummy	8	BYTE	For adjusting overall sub chunk size to 40 kByte

paus sub chunk (fixed to 40 kB, VA-12 specific)

Variable name	Bytes	Type	Content
chunkID	4	char	“paus”
chunkSize	4	DWORD	Chunk size (in bytes): 40952
PAUSETIMEFORMAT	40952	Constituent	Reserved

Command List

System

Command	Function	Page
Beep	Beep.....	142

Status

Command	Function	Page
Analysis Mode	Analysis mode	142
Data Type	Measurement data type	142

Measurement parameters

Command	Function	Page
High Pass Filter	High-pass filter.....	142
Low Pass Filter	Low-pass filter.....	143
Level Range	Input range	143
Frequency Span	Frequency span	143
Analysis Line	Number of analysis lines	143
Average Disp	Average display	144
Average Type	Operation type	144
Average Count	Average number.....	144
Window Function	Time window function	144
Pickup Sensitivity Num	Accelerometer sensitivity (numeral)	144
Pickup Sensitivity Magnify	Accelerometer sensitivity (factor)	145
Sensor Type	Sensor selection	145

Trigger

Command	Function	Page
Trigger Mode	Trigger mode.....	145
Trigger Source	Trigger source.....	145
Trigger Level	Trigger level	145
Trigger Slope	Trigger slope.....	146
Pretrigger	Pretrigger.....	146

Axis/zoom settings

Command	Function	Page
FFT Expand X	FFT X axis zoom.....	146
FFT Expand Y Log	FFT Y axis zoom (Log).....	146
FFT Expand Y LIN	FFT Y axis zoom (Lin).....	147
TIME Expand X	Time X axis zoom	147
TIME Expand Y	Time Y axis zoom	147

Cursor related operations

Command	Function	Page
Cursor Position FFT	FFT cursor position (line position)	147
Cursor Position LIST	List cursor position.....	147
Cursor Position Time	Time cursor position	147

Display

Command	Function	Page
Scale VM	VM graph X axis scale	148
Scale Unit FFT Y	FFT graph Y axis scale	148
Cursor Unit FFT X	FFT cursor X axis unit.....	148
Cursor Unit FFT Y	FFT cursor Y axis unit.....	148
List Display	List display.....	148
Time Display	Time display.....	149
Zoom Mode	Display scaling mode	149
Zoom Move	Zoom/Move mode	149
Layer Display	Overlay display On/Off.....	149

Memory

Command	Function	Page
Store Name	Store name	150
Store Number	Store number	150
Store Interval	Store interval.....	150
Store Start Time	Timer store start time	150
Wave Recording	Waveform recording On/Off	150

Command Description

System

Beep setting command

Beep, p1

Parameter	Content
p1 = "Off"	Beep off
p1 = "On"	Beep on

Status

Analysis mode setting command

Analysis_Mode, p1

Parameter	Content
p1 = "VM"	Vibration meter
p1 = "TIME"	Time waveform
p1 = "FFT"	FFT graph
p1 = "LIST"	FFT list

Measurement data type setting command

Data_Type, p1

Parameter	Content
p1 = "Acceleration"	Acceleration
p1 = "Velocity"	Velocity
p1 = "Displacement"	Displacement
p1 = "Acc. Envelope"	Envelope

Measurement parameters

High-pass filter setting command

High_Pass_Filter, p1

Parameter	Content
p1 = "1Hz"	1 Hz
p1 = "3Hz"	3 Hz
p1 = "10Hz"	10 Hz
p1 = "1kHz"	1 kHz

Low-pass filter setting command

Low_Pass_Filter, p1

Parameter	Content
p1 = "1kHz"	1 kHz
p1 = "5kHz"	5 kHz
p1 = "20kHz"	20 kHz

Input range setting command

Level_Range, p1

Parameter	Content
p1 = "0" to "6"	An actual value is different according to the setting. 0 is the lowest range setting, then 1, 2, etc.

Frequency span setting command

Frequency_Span, p1

Parameter	Content
p1 = "100Hz"	100 Hz
p1 = "200Hz"	200 Hz
p1 = "500Hz"	500 Hz
p1 = "1kHz"	1 kHz
p1 = "2kHz"	2 kHz
p1 = "5kHz"	5 kHz
p1 = "10kHz"	10 kHz
p1 = "20kHz"	20 kHz

Number of analysis lines setting command

Analysis_Line, p1

Parameter	Content
p1 = "200"	200 lines
p1 = "400"	400 lines
p1 = "800"	800 lines
p1 = "1600"	1600 lines
p1 = "3200"	3200 lines

Average display setting command

Average_Dis, p1

Parameter	Content
p1 = "Lp"	Instantaneous value
p1 = "Ave"	Average

Operation type setting command

Average_Type, p1

Parameter	Content
p1 = "Linear"	Linear average
p1 = "Exp"	Exponential average
p1 = "Max"	Maximum hold

Average number setting command

Average_Count, p1

Parameter	Content
p1 = 1 to 2048	Averaging number of FFT processing

Time window function setting command

Window_Function, p1

Parameter	Content
p1 = "Rectangular"	Rectangular window
p1 = "Hanning"	Hanning window
p1 = "Flattop"	Flat-top window

Accelerometer sensitivity (numeral) setting command

Pickup_Sensitivity_Num, p1

Parameter	Content
p1 = 100 to 999	Pickup Sensitivity (numeral)

Accelerometer sensitivity (factor) setting command

Pickup_Sensitivity_Magnify, p1

Parameter	Content
p1 = "x0.1"	×0.1
p1 = "x0.01"	×0.01
p1 = "x0.001"	×0.001

Sensor selection setting command

Sensor_Type, p1

Parameter	Content
p1 = "PV-57I"	PV-57I
p1 = "Other"	Other

Trigger

Trigger mode setting command

Trigger_Mode, p1

Parameter	Content
p1 = "Free"	Free
p1 = "Repeat"	Repeat Trigger
p1 = "Single"	Single Trigger
p1 = "Time"	Time Trigger

Trigger source setting command

Trigger_Source, p1

Parameter	Content
p1 = "Level Trigger"	Level Trigger
p1 = "External Trigger"	External Trigger

Trigger level setting command

Trigger_Level, p1

Parameter	Content
p1 = -7 to 7	-7/8 to 7/8

Trigger slope setting command

Trigger_Slope, p1

Parameter	Content
p1 = “-”	Slope -
p1 = “+”	Slope +

Pretrigger setting command

Pretrigger, p1

Parameter	Content
p1 = “None”	OFF
p1 = “Pretrigger”	ON

Axis/zoom settings

FFT X axis zoom setting command

FFT_Expand_X, p1

Parameter	Content
p1 = “x1”	×1
p1 = “x2”	×2
p1 = “x4”	×4
p1 = “x8”	×8
p1 = “x16”	×16

FFT Y axis zoom (Log) setting command

FFT_Expand_Y_Log, p1

Parameter	Content
p1 = “80”	80 dB
p1 = “60”	60 dB
p1 = “40”	40 dB
p1 = “20”	20 dB

FFT Y axis zoom (Lin) setting command

FFT_Expand_Y_LIN, p1

Parameter	Content
p1 = 0 to 10	2^0 to 2^{10}

Time X axis zoom setting command

TIME_Expand_X, p1

Parameter	Content
p1 = "x1"	×1
p1 = "x2"	×2
p1 = "x4"	×4
p1 = "x8"	×8
p1 = "x16"	×16
p1 = "x32"	×32

Time Y axis zoom setting command

TIME_Expand_Y, p1

Parameter	Content
p1 = -7 to 14	2^{-7} to 2^{14}

Cursor related operations

FFT cursor position (line position) setting command

Cursor_Position_FFT, p1

Parameter	Content
p1 = 0 to 3200	

List cursor position setting command

Cursor_Position_LIST, p1

Parameter	Content
p1 = 0 to 9	

Time cursor position setting command

Cursor_Position_Time, p1

Parameter	Content
p1 = 0 to 8191	

Display

VM graph X axis scale setting command

Scale_VM, p1

Parameter	Content
p1 = "Log"	Logarithmic scale
p1 = "Linear"	Linear scale

FFT graph Y axis scale setting command

Scale_Unit_FFT_Y, p1

Parameter	Content
p1 = "Log"	Logarithmic scale
p1 = "Linear"	Linear scale

FFT cursor X axis unit setting command

Cursor_Unit_FFT_X, p1

Parameter	Content
p1 = "Hz"	Hz (Hertz)
p1 = "kcpm"	kcpm (Kilo Cycle per Minute)
p1 = "odr"	order (Reference frequency set)

FFT cursor Y axis unit setting command

Cursor_Unit_FFT_Y, p1

Parameter	Content
p1 = "Log"	Logarithmic scale
p1 = "Linear"	Linear scale

List display setting command

List_Display, p1

Parameter	Content
p1 = "Off"	OFF
p1 = "On"	ON

Time display setting command

Time_Display, p1

Parameter	Content
p1 = "Off"	OFF
p1 = "On"	ON

Display scaling mode setting command

Zoom_Mode, p1

Parameter	Content
p1 = "Off"	OFF
p1 = "On"	ON

Zoom/Move mode setting command

Zoom_Move, p1

Parameter	Content
p1 = "Zoom"	Zoom mode
p1 = "Move"	Move mode

Overlay display On/Off setting command

Layer_Display, p1

Parameter	Content
p1 = "Off"	Off
p1 = "On"	Overlapping
p1 = "Clear"	Delete

Memory

Store name setting command

Store_Name, p1

Parameter	Content
p1 = 0000 to 9999	MAN_0000 to MAN_9999

Store number setting command

Store_Number, p1

Parameter	Content
p1 = 1 to 1000	

Store interval setting command

Store_Interval, p1

Parameter	Content
p1 = "1min"	1 minute
p1 = "5min"	5 minutes
p1 = "10min"	10 minutes
p1 = "30min"	30 minutes
p1 = "60min"	60 minutes

Timer store start time setting command

Store_Start_Time, p1

Parameter	Content
p1 = "YYYY/MM/DD_00:00:00" to "YYYY/MM/DD_23:59:00"	YYYY/MM/DD_hh:mm:ss (ss is fixed to "00")

Waveform recording On/Off setting command

Wave_Recording, p1

Parameter	Content
p1 = "Off"	OFF
p1 = "On"	ON

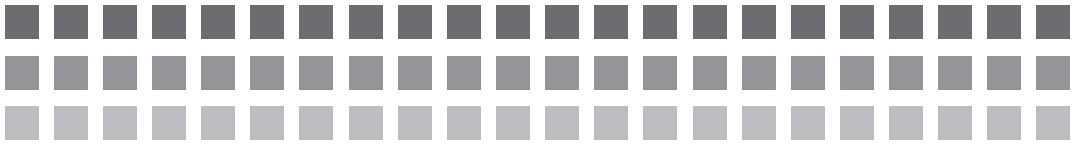

Other Information



Specifications

Standard compliance

CE marking CE requirements are met provided that a core filter is fitted to every cable

China RoHS (export model for China only)

WEEE Directive

Piezoelectric accelerometer PV-57I (supplied accessory)

Accelerometer type

Shear-type piezoelectric accelerometer (CCLD type)

Sensitivity Listed on supplied calibration chart of PV-57I.

Frequency range 1 Hz to 5 kHz ($\pm 10\%$)

Dimensions 17 mm (width across hexagonal flat) \times 49 mm

Weight Approx. 45 g

Magnet attachment Approx. 15 g

Input section

Input connectors

Accelerometer connector

\times 1 channel (BNC)

Connector for piezoelectric accelerometer (standard supplied accelerometer: PV-57I)

Sensor drive (CCLD: 18 V, 2 mA) supported

(CCLD: 24 V, 4 mA available as factory option)

PV-57I with integrated preamplifier (CCLD type)

Frequency range: 1 Hz to 5 kHz

Maximum continuous acceleration

measurement limit: 200 m/s² peak

External trigger input connector (TRIG IN)

\times 1 (ultra mini jack, 2.5 mm dia.)

External trigger control using falling edge of TTL level signal

OPTION connector

For future expansion (currently not used)

Measured vibration quantities

Acceleration: Signal input from accelerometer

Velocity: Calculated by first-order integration from acceleration signal

Displacement:

Calculated by second-order integration from acceleration signal

Acceleration envelope curve:

1 kHz to 20 kHz acceleration envelope curve signal (analyzer mode only)

Input range

At sensitivity 0.100 mV/(m/s²) to 0.999 mV/(m/s²)

Acceleration: 10 , 31.6 , 100 , 316 , 1000 , 3160 , 10000
(m/s²) (rms)

Velocity: 31.6, 100, 316, 1000, 3160, 10000, 31600
(mm/s) (rms)

Displacement:
0.89, 2.83, 8.94, 28.3, 89.4, 283, 894 (mm)
(EQp-p)

Using PV-57I, or at sensitivity 1.00 mV/(m/s²) to 9.99 mV/(m/s²)

Acceleration: 1, 3.16, 10, 31.6, 100, 316, 1000 (mm/s)
(rms)

Velocity: 3.16, 10, 31.6, 100, 316, 1000, 3160 (mm/s)
(rms)

Displacement:
0.089, 0.283, 0.894, 2.83, 8.94, 28.3, 89.4
(mm) (EQp-p)

At sensitivity 10.0 mV/(m/s²) to 99.9 mV/(m/s²)

Acceleration: 0.1, 0.316, 1, 3.16, 10, 31.6, 100 (m/s²)
(rms)

Velocity: 0.316, 1, 3.16, 10, 31.6, 100, 316 (mm/s)
(rms)

Displacement:
0.0089, 0.0283, 0.0894, 0.283, 0.894,
2.83, 8.94 (mm) (EQp-p)

Measurement range

(using PV-57I, high-pass filter 3 Hz, low-pass filter 20 kHz)

Acceleration: 0.02 m/s² to 141.4 m/s² (rms) (limited
by maximum continuous measurement
acceleration of PV-57I)

Instantaneous maximum acceleration:
700 m/s²

Velocity: 0.2 mm/s to 141.4 mm/s (rms) (at 159.15 Hz)

Displacement:
0.02 mm to 40.0 mm (EQp-p) (at 15.915 Hz)

Measurement frequency range (electrical characteristics)

Acceleration: 1 Hz to 20 kHz

Velocity: 3 Hz to 3 kHz

Displacement:

3 Hz to 500 Hz

Acceleration envelope curve:

1 kHz to 20 kHz

Filters

Prefilters

High-pass filter:

1 Hz*, 3 Hz, 10 Hz, 1 kHz (–10% point)

Cutoff slope –18 dB/oct,

* 1 Hz for acceleration only

Low-pass filter:

1 kHz, 5 kHz, 20 kHz (–10% point)

Cutoff slope –18 dB/oct

Acceleration envelope curve filter

High-pass filter:

1 kHz (–10% point),

cutoff slope –18 dB/oct

Residual noise

(high-pass filter 3 Hz, low-pass filter 20 kHz, lowest range setting)

Acceleration: 0.01 m/s² (rms) or less

Velocity: 0.1 mm/s (rms) or less

Displacement:

0.01 mm (EQp-p) or less

A/D conversion 24 bit delta-sigma principle, 51.2 kHz sampling

Analysis functions

Vibration meter mode (acceleration, velocity, displacement all-pass value also calculated simultaneously)

Detection characteristics:

rms detection, peak detection

Sampling frequency:

51.2 kHz

Measurement data type:

The following items are calculated simultaneously (by digital processing)

Acceleration (m/s²):

rms value, peak value, crest factor

Velocity (mm/s):

rms value

Displacement (mm):

EQp-p value (rms value $\times 2\sqrt{2}$)

rms time constant:

1 second

Peak value, crest factor:

updated every second

Time waveform mode (waveform of acceleration, velocity, displacement or acceleration envelope curve)

Frequency span:

100 Hz, 200 Hz, 500 Hz, 1 kHz, 2 kHz, 5 kHz, 10 kHz, 20 kHz

Number of waveform samples (analysis lines):

512, 1024, 2048, 4096, 8192 (200, 400, 800, 1600, 3200)

FFT mode (spectrum of acceleration, velocity, displacement or acceleration envelope curve)

Measurement data type:

The following items are measured separately

Acceleration (m/s²):

rms value

Velocity (mm/s):

rms value

Displacement (mm):

EQp-p value (rms value $\times 2\sqrt{2}$)

Frequency span:

100 Hz, 200 Hz, 500 Hz, 1 kHz, 2 kHz, 5 kHz, 10 kHz, 20 kHz

Number of analysis lines (waveform samples):

200, 400, 800, 1600, 3200 (512, 1024, 2048, 4096, 8192)

Time window function:

Rectangular, Hanning, Flat-top

Averaging processing:

Linear average, exponential average, maximum hold

Waveform recording function (exclusive use for recording)

During FFT averaging processing, waveform data can be saved on SD card in WAVE file format (max. 1 MB per file).

(FFT analysis using WAVE files cannot be performed on VA-12.)

Recording time examples:

10 seconds at 20 kHz frequency span,
2000 seconds at 100 Hz frequency span

Trigger

Trigger modes Free-run, Repeat, Single, Timer

Trigger source: External signal, input level

Trigger level: Can be set in steps of 1/8 of full scale on one-sided amplitude

Trigger slope: +/- (direction for input signal to cross trigger level)

Pretrigger function:

Waveform data sampling starts from a point preceding the current point by 1/8 of frame time

Display

Display Color TFT LCD, 240 × 320 dots

Backlight type: EL

Output accuracy (unit electrical characteristics)

Acceleration (ACC) range full-scale $\pm 2\%$ (80 Hz)

Velocity (VEL) range full-scale $\pm 3\%$ (80 Hz)

Displacement (DISP) range full-scale $\pm 5\%$ (80 Hz)

Display content

Measurement data:

Processing result, cursor, measurement parameters, overload history

Status information:

Current date/time (24-hour format), overload, trigger settings, waveform recording settings, operation comments etc.

Status: Power supply type (AC, batteries), remaining battery capacity (5 steps), SD card information, graph zoom, waveform recording, trigger settings etc.

Data display content

Vibration meter mode:

Acceleration, velocity, displacement, acceleration peak value, acceleration crest factor

Acceleration, velocity, or displacement bar graph

FFT mode: Spectrum graph display or list display

Graph display:

X axis: Entire spectrum data are represented by 201 display points, overall value excluding DC components indicated by bar graph
Zoom function allows expansion of display according to number of analysis lines, as shown in table below.

Number of analysis lines (waveform samples)	Zoom factor (power of two)
200 (512)	×1
400 (1024)	×1 to ×2
800 (2048)	×1 to ×4
1600 (4096)	×1 to ×8
3200 (8192)	×1 to ×16

Y axis: Log, Linear

Log display range:

80 dB, 60 dB, 40 dB, 20 dB

Linear zoom function:

1 to 2^{10} (power of two)

Overlay display function:

For comparison of measurement data and selected store data (all settings for measurement data type, frequency span, and number of analysis lines must match)

List display:

Alphanumeric indication of 10 highest level data on graph display with corresponding frequencies (excluding DC)

Cursor value:

X axis: Hz, kcpm, order

Y axis: Linear (m/s^2 , mm/s, mm), Log

Time waveform mode:

Graph display:

X axis: 201 display points are used to represent all waveform sample data
Zoom function allows expansion of display according to number of samples, as shown in table below.

Number of samples (number of analysis lines)	Zoom factor (power of two)
512 (200)	×1 to ×2
1024 (400)	×1 to ×4
2048 (800)	×1 to ×8
4096 (1600)	×1 to ×16
8192 (3200)	×1 to ×32

Y axis: Linear display only
Zoom function:
1 to 2^{14} (power of two)

Cursor value:

X axis: Time (ms)
Y axis: Amplitude (m/s², mm/s, mm)

Memory

- Memory media SD cards (max. 2 GB)
- Data store files Vibration meter data store file, waveform data store file, FFT data store file
Up to 1000 data store files can be saved under one store name, up to 100 store names allowed
- WAVE files Stored by waveform recording function along with FFT data
- BMP files Screen capture data can be saved as BMP files
- Parameter setting memory
Up to five sets of measurement parameter sets can be saved in the memory of the unit. Five sets can be stored as a group on SD card and loaded back into the unit. Swapping the current settings for saved settings and vice versa is possible.
- Recall function Measurement data can be read from SD card and redisplayed on screen.
FFT analysis of stored time waveform data on the VA-12 is not supported.

Startup functions

Resume function Settings are memorized when power is turned off and restored at next power-on

Loading setup files at startup

A specific file of settings stored on SD card can be loaded automatically at startup

Input/output section

USB port ×1 (Mini B)

Removable disk function

Allows use of SD card inserted in unit as removable storage device

Required cable type: USB A - Mini B cable (compliant with USB 2.0 standard)

Printer function

Dedicated USB printer (BL-112UI) can be used for printing

Screen print: Current display contents (hard copy)

Continuous print:

Continuous printing of specified store address range

Cable type: USB Mini B - B cable

Beep

For audible feedback of switch operation and measurement status check

Ambient temperature and humidity conditions for use

Piezoelectric accelerometer PV-57I

−20°C to +70°C, 90% RH or less

Main unit

−10°C to +50°C, 90% RH or less (no condensation)

Power supply section

Power source IEC R6 (size AA) batteries or dedicated AC adapter NC-99 series

Batteries: Eight IEC R6 (size AA) batteries

Battery life: Approx. 12 hours (23°C, alkaline batteries, backlight off)

* Battery life may differ significantly, depending on ambient temperature, unit settings, and brand and type of batteries and SD memory card

External DC: 12 V (11 V to 15 V)

Power consumption:

Approx. 145 mA (23°C, normal operation, backlight off)

Power consumption (primary side):

Approx. 10 VA (in case of AC 100 V (NC-99 series))

Dimensions

Without protective cover

231 mm (232 mm with BNC connector) (H) × 105 mm (W)
× 36 mm (D)

With protective cover

238 mm (H) × 131 mm (W) × 44 mm (D)

Mass

Approx. 850 g (incl. batteries, with protective cover,
PV-57I connected)

Supplied accessories

Piezoelectric Accelerometer	PV-57I	1
Curled cable	VP-51KI	1
Magnet attachment	VP-53S	1
PV-57I calibration chart		1
IEC R6 (size AA) battery	LR6	8
Instruction Manual		1
SD card 512 MB		1
Protective cover		1
Shoulder belt		1
Inspection certificate		1

Optional accessories

Waveform Analysis Software	AS-70/CAT-WAVE
Various accelerometers	PV-91C etc.
BNC adapter	VP-52C
Charge converter	VP-40
SD card	512 MB
SD card	2 GB
AC adapter	NC-99 series
BNC - mini plug cable	CC-24
USB printer (*discontinued in 2010)	BL-112UI
Thermosensitive paper (10 rolls)	P-112-30
USB Mini B - B cable (for printer connection)	CC-97
USB A - Mini B cable (for removable disk connection)	Commercially available

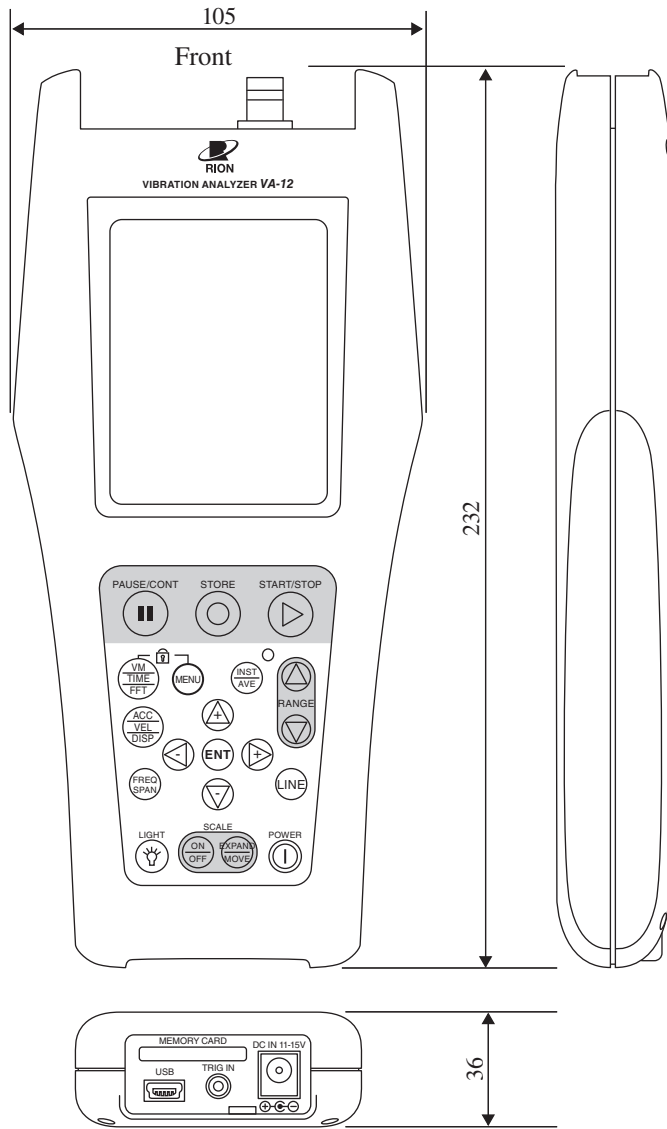

Unit: mm

Dimensional drawing (without protective cover)

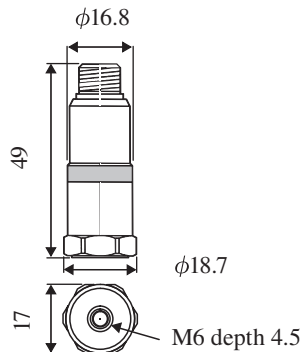

Unit: mm

Supplied accessories: Piezoelectric Accelerometer PV-57I dimensional drawing

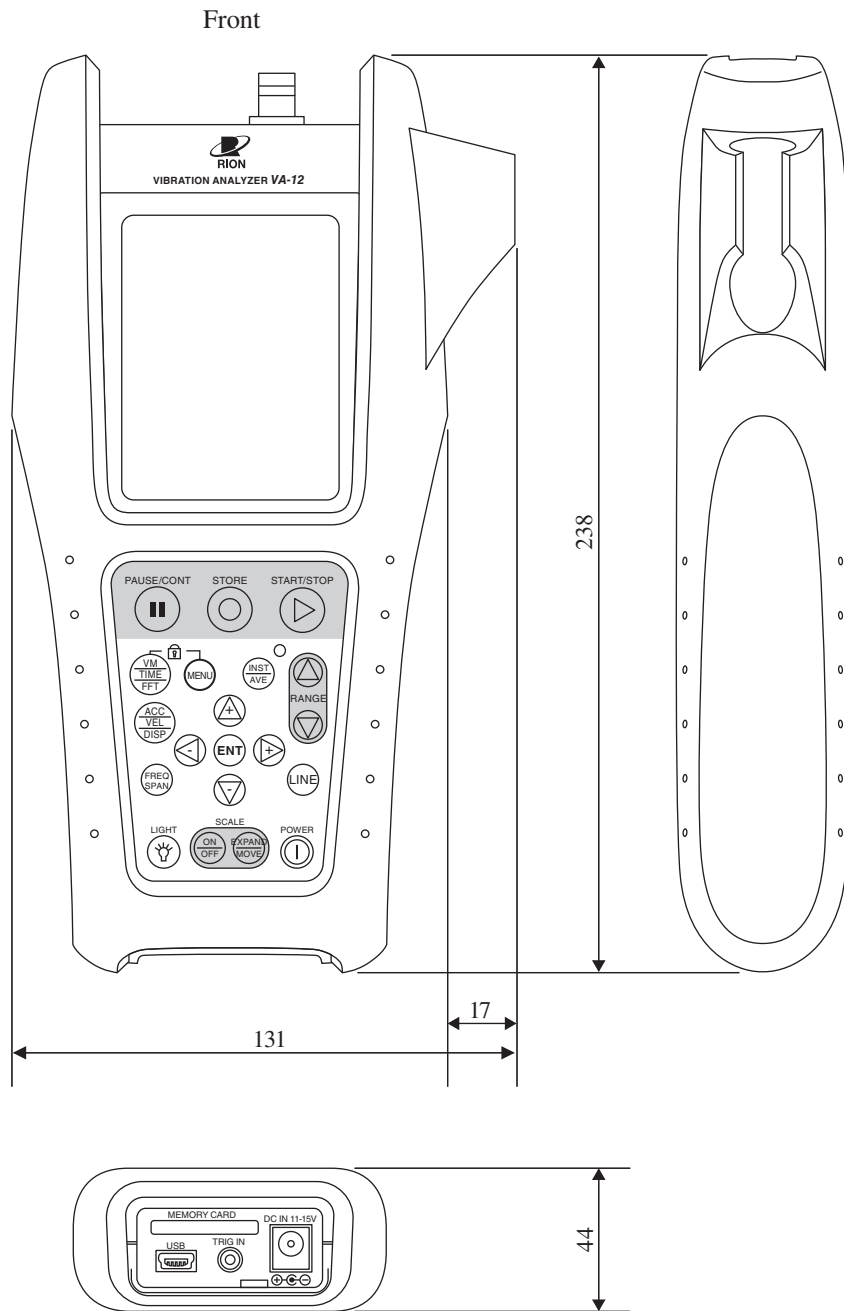

Unit: mm

Dimensional drawing (with protective cover)

Index

A

acceleration crest factor indication	35
acceleration peak value indication.....	35
acceleration rms value indication	35
accelerometer	14
AC adapter	12
analysis function	28, 32, 42, 56
auto shut-off.....	120
Average number	58, 67

B

backlight	121
battery life.....	119
BMP File.....	85

C

Current averaging count.....	58
cursor	46, 61
cursor move	45, 60
cursor value	46
cursor value readout and unit.....	61
cursor X axis unit	68

D

deleting stored data	84
displacement equivalent p-p value indication	35

E

exponential averaging.....	71, 73
external trigger.....	94

F

FFT mode	55
file structure.....	127
free.....	91
frequency span	43, 57

G

graph zoom 45, 60

H

high-pass filter..... 33, 42, 56

I

initialization 113

INPUT connector 8

input range 32, 42, 56, 66

instantaneous value 71, 73

K

key lock..... 6, 36, 47, 63

L

level trigger 93

linear averaging..... 71, 74

list display 64

low-pass filter 33, 43, 56

M

maximum hold 71, 74

measurement data type..... 32, 43, 58

menu 22

N

number of analysis lines..... 43, 57

O

operation type 58, 67, 71

OPTION connector 8

overall 59, 60, 82

overlay 60, 110

overload indication 34

P

power supply	119
pretrigger	94
printer	21
printing	87
printing stored data continuously	88
protective cover	20
PV-57I	14

R

re-analyzing	78
recall	79, 82
repeat	91, 93
repeat trigger	97
resume	112

S

scale	
FFT scale	62, 68
vibration meter scale	38
scroll bar	44, 59
SD card	17, 36, 47, 63, 124
selecting the language	19
sensor settings	38, 49, 65
setting commands	139
setting items	117
setting the current date/time	18
setup file	112
shoulder belt	20
single	92, 93
single trigger	101
status display	122
store address	34, 44, 59, 82
store name	67
storing measurement data	40, 54, 75
symbol	122

T

time.....	92
time trigger	33, 95, 104
time waveform mode.....	41
trigger function	91

V

velocity rms value indication.....	35
vibration meter mode	31
VP-53S.....	14

W

waveform data.....	77
waveform recording.....	57, 77
WAVE file.....	133
window function	57

X

X axis unit	45, 60
X axis zoom factor	45, 52, 60

Y

Y axis unit	46, 62
Y axis zoom factor	53, 61

Z

zooming/moving the display (FFT mode).....	69
zooming/moving the display (time waveform mode)	51

